

FR

CS

DA

DE

EL

EN

ES

FI

IT

NL

NO

PL

PT

SK

SV

Brandt



INSTRUCTIONS UTILISATEUR FR

FOUR

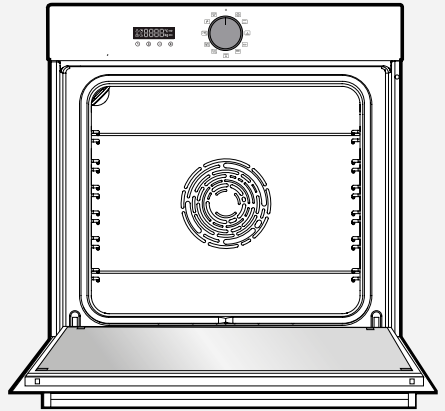

CZ2100017

ORIGINE
FRANCE[®]
GARANTIE

BYCert.6011825

Chère Cliente, Cher Client,

Vous venez d'acquérir un produit **BRANDT** et nous vous remercions de la confiance que vous nous accordez.

Nous avons conçu et fabriqué ce produit en pensant à vous, à votre mode de vie, à vos besoins, pour qu'il réponde au mieux à vos attentes. Nous y avons mis notre savoir-faire, notre esprit d'innovation et toute la passion qui nous anime depuis plus de 60 ans.

Dans un souci permanent de toujours mieux satisfaire vos exigences, notre service consommateurs est à votre disposition et à votre écoute pour répondre à toutes vos questions ou suggestions.

Connectez-vous aussi sur notre site **www.brandt.com** où vous trouverez nos dernières innovations, ainsi que des informations utiles et complémentaires.

BRANDT est heureux de vous accompagner au quotidien et vous souhaite de profiter pleinement de votre achat.



Le label « Origine France Garantie » assure au consommateur la traçabilité d'un produit en donnant une indication de provenance claire et objective. La marque BRANDT est fière d'apposer ce label sur les produits issus de nos usines françaises basées à Orléans et Vendôme.

Retrouvez-nous sur

<https://brandt.fr/>

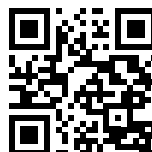

Important :

Avant de mettre votre appareil en marche, veuillez lire attentivement ce guide afin de vous familiariser plus rapidement avec son fonctionnement.



INSTRUCTIONS DE SÉCURITÉ	4
ENVIRONNEMENT ET ECONOMIE D'ENERGIE	6
Environnement	6
Conseil d'économie d'énergie.....	6
INSTALLATION DE VOTRE APPAREIL	7
Choix de l'emplacement et encastrement.....	7
Raccordement électrique.....	8
DESCRIPTION DE VOTRE APPAREIL	9
Présentation du four	9
Afficheur et touches de commandes	9
Accessoires	10
UTILISATION DE VOTRE APPAREIL	12
Réglages.....	12
Menu réglages.....	13
Les modes de cuisson	14
Démarrage d'une cuisson	15
ENTRETIEN DE VOTRE APPAREIL	17
Nettoyage intérieur - extérieur.....	18
ANOMALIES ET SOLUTIONS	19
SERVICE APRÈS-VENTE	21
Interventions	21
Relations consommateurs FRANCE	21
AIDE A LA CUISSON	21
Tableaux de cuissons.....	22
Recettes avec levure	24
Essais d'aptitude a la fonction.....	25
Fonctions avec vapeur combinées automatiques	26



Instructions de sécurité importantes lire avec attention et garder pour de futures utilisations.

Cette notice est disponible en téléchargement sur le site internet de la marque.

A la réception de l'appareil

Déballer-le ou faites le déballer immédiatement. Vérifiez son aspect général. Faites les éventuelles réserves par écrit sur le bon de livraison dont vous gardez un exemplaire.

Avant la 1ère utilisation

Chauffez votre four à vide pendant 15 minutes environ. Assurez-vous que la pièce est suffisamment aérée.

Informations importantes

Cet appareil a été conçu pour être utilisé par des particuliers dans leur lieu d'habitation. Ce four ne contient aucun composant à base d'amiante.

Votre appareil est destiné à un usage domestique normal. Ne l'utilisez pas à des fins commerciales ou industrielles ou pour d'autres buts que celui pour lequel il a été conçu.

Ne modifiez pas ou n'essayez pas de modifier les caractéristiques de cet appareil. Cela représenterait un danger pour vous.

Ne placez jamais de papier d'aluminium directement en contact

avec la sole, la chaleur accumulée pourrait entraîner une détérioration de l'émail.

Sur la porte ouverte du four, ne posez pas de charges lourdes, et assurez-vous qu'un enfant ne puisse ni monter ni s'asseoir.

Ne vous servez pas de votre four comme garde-manger ou pour stocker quelconques éléments après utilisation.

Après utilisation de votre four, assurez-vous que toutes les commandes se trouvent sur la position arrêté.

Pour toute intervention de nettoyage dans la cavité du four, le four doit être arrêté.

Avant de procéder au déclippage de la glace, laissez refroidir l'appareil.

Consignes de sécurité

- Cet appareil peut être utilisé par des enfants âgés de 8 ans et plus, et par des personnes aux capacités physiques, sensorielles ou mentales réduites, ou dénuées d'expérience et de connaissance, si elles ont pu bénéficier d'une



surveillance ou d'instructions préalables concernant l'utilisation de l'appareil de façon sûre et en ont compris les risques encourus. Les enfants ne doivent pas jouer avec l'appareil. Les opérations de nettoyage et de maintenance ne doivent pas être faites par des enfants laissés sans surveillance.

- Il convient de surveiller les enfants pour s'assurer qu'ils ne jouent pas avec l'appareil.

MISE EN GARDE :

- L'appareil et ses parties accessibles deviennent chaudes au cours de l'utilisation. Faire attention à ne pas toucher les éléments chauffants situés à l'intérieur du four. Les enfants de moins de 8 ans doivent être tenus à l'écart à moins qu'ils ne soient surveillés en permanence.

- Cet appareil est conçu pour faire des cuissons porte fermée.

- Avant de procéder à un nettoyage pyrolyse de votre four, retirez tous les accessoires et enlevez les éclaboussures importantes.

- Dans la fonction de nettoyage, les surfaces peuvent devenir plus chaudes qu'en usage normal. Il est recommandé d'éloigner les enfants.

- Ne pas utiliser d'appareil de nettoyage à la vapeur.

- Ne pas utiliser de produits d'entretien abrasifs ou de grattoirs métalliques durs pour nettoyer la porte en verre du four, ce qui pourrait érafler la surface et entraîner l'éclatement du verre.

MISE EN GARDE :

- S'assurer que l'appareil est déconnecté de l'alimentation avant de remplacer la lampe pour éviter tout risque de choc électrique. Intervenez lorsque l'appareil est refroidi. Pour devisser le hublot et la lampe, utilisez un gant de caoutchouc qui facilitera le démontage.

- La fiche de prise de courant doit être accessible après installation.

- Il doit être possible de déconnecter l'appareil du réseau d'alimentation, soit à l'aide d'une fiche de prise de courant, soit en incorporant un interrupteur dans les canalisations fixes conformément aux règles d'installation.

- Si le câble d'alimentation est endommagé, il doit être remplacé par le fabricant, son service après-vente ou une personne de qualification similaire afin d'éviter un danger.

- Cet appareil peut être installé indifféremment sous plan ou en colonne comme indiqué sur le schéma d'installation.



Installation de votre appareil

- Centrez le four dans le meuble de façon à garantir une distance minimum de 10 mm avec le meuble voisin.
- La matière du meuble d'encastrement doit résister à la chaleur (ou être revêtu d'une telle matière). Pour plus de stabilité, fixez le four dans le meuble par 2 vis au travers des trous prévus à cet effet sur les montants latéraux.
- L'appareil ne doit pas être installé derrière une porte décorative, afin d'éviter une surchauffe.



Environnement et économie d'énergie

ENVIRONNEMENT

Les matériaux d'emballage de cet appareil sont recyclables. Participez à leur recyclage et contribuez ainsi à la protection de l'environnement en les déposant dans les conteneurs municipaux prévus à cet effet.



Votre appareil contient également de nombreux matériaux recyclables. Il est donc marqué de ce logo afin de vous indiquer que les appareils usagés ne doivent pas être mélangés avec d'autres déchets.

Le recyclage des appareils qu'organise votre fabricant sera ainsi réalisé dans les meilleures conditions, conformément à la directive européenne en vigueur sur les déchets d'équipements électriques et électroniques.

Adressez-vous à votre mairie ou à votre revendeur pour connaître les points de collecte des appareils usagés les plus proches de votre domicile.

Nous vous remercions pour votre collaboration à la protection de l'environnement.

CONSEIL D'ÉCONOMIE D'ÉNERGIE

Pendant la cuisson, gardez la porte du four fermée.



CHOIX DE L'EMPLACEMENT ET ENCASTREMENT

Les schémas déterminent les côtes d'un meuble qui permettra de recevoir votre four. Cet appareil peut être installé indifféremment en colonne (A) ou sous plan (B). Si le meuble est ouvert, son ouverture doit être de 70 mm maximum à l'arrière (C et D). Fixez le four dans le meuble. Pour cela retirez les butées en caoutchouc et pré-percez un trou de \varnothing 2 mm dans la paroi du meuble pour éviter l'éclatement du bois. Fixez le four avec les 2 vis. Remplacez les butées caoutchouc.



Conseil :

Pour être assuré d'avoir une installation conforme, n'hésitez pas à faire appel à un spécialiste de l'électroménager.



Attention :

Si l'installation électrique de votre habitation nécessite une modification pour le branchement de votre appareil, faites appel à un électricien qualifié. Si le four présente une quelconque anomalie, débranchez l'appareil ou enlevez le fusible correspondant à la ligne de branchement du four.

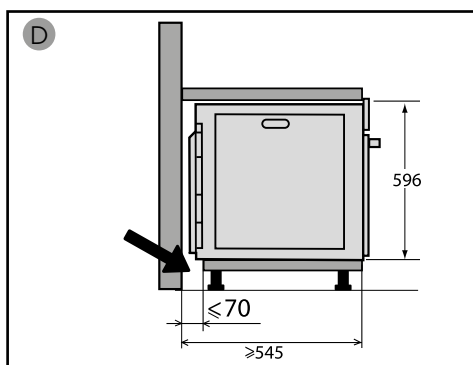
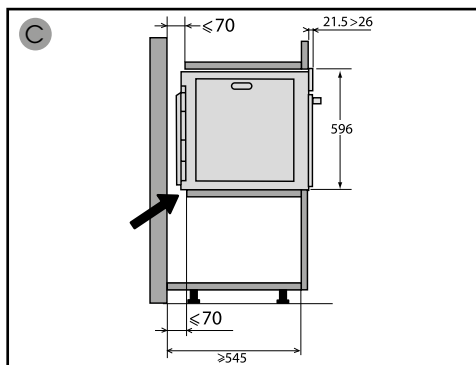
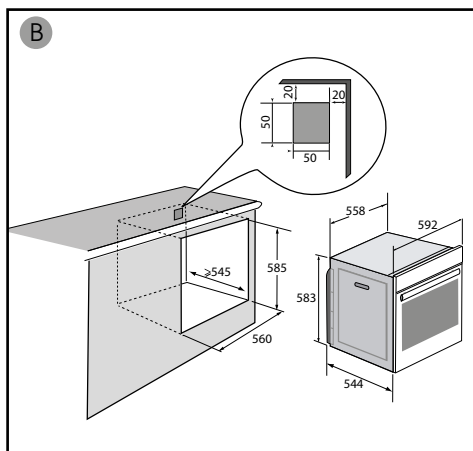
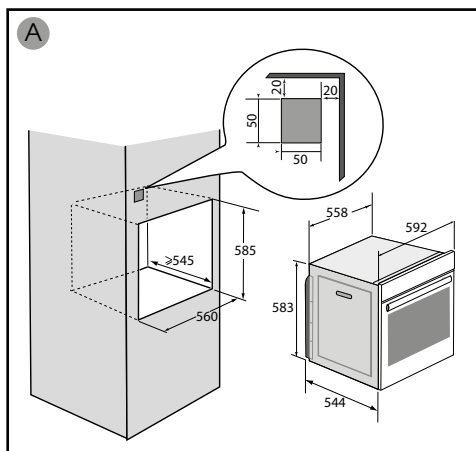



RACCORDEMENT ÉLECTRIQUE

Le four doit être branché avec un câble d'alimentation normalisé à 3 conducteurs de 1,5 mm² (1 ph + 1 N + terre) qui doivent être raccordés sur le réseau 220~240 Volts par l'intermédiaire d'une prise de courant normalisée CEI 60083 ou d'un dispositif de coupure omnipolaire conformément aux règles d'installation.

Attention

Le fil de protection (vert-jaune) est relié à la borne  de l'appareil et doit être relié à la terre de l'installation. Le fusible de l'installation doit être de 16 ampères.

Notre responsabilité ne saurait être engagée en cas d'accident ou d'incident consécutif à une mise à la terre inexistante, défectueuse ou incorrecte ni en cas de branchement non conforme.

• Avant la première utilisation

Avant d'utiliser votre four pour la première fois, chauffez-le à vide, porte fermée pendant 15 minutes environ sur la température la plus élevée. afin de roder l'appareil. La laine minérale qui entoure la cavité du four peut dégager au début une odeur particulière due à sa composition. De même, vous constaterez peut-être un dégagement de fumée. Tout ceci est normal.

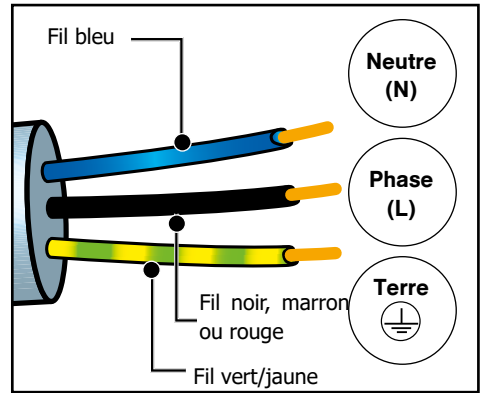



Présentation de votre appareil

PRÉSENTATION DU FOUR

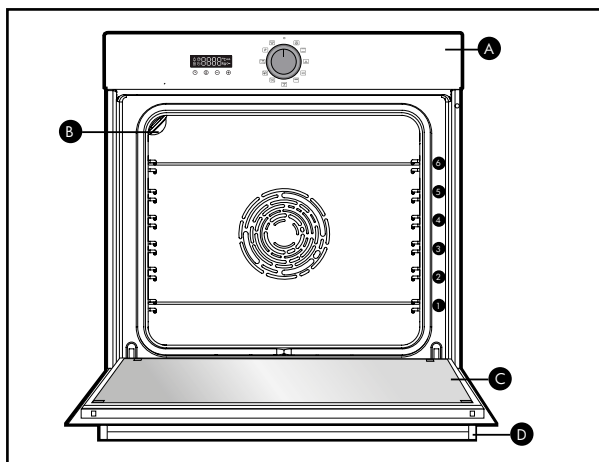

- A** Bandeau de commande
- B** Lampe
- C** Porte
- D** Poignée

Ce four dispose de 6 positions de gradins pour les accessoires : gradins de 1 à 6.

AFFICHEUR ET TOUCHES DE COMMANDES

• Afficheur



- Durée de cuisson
- Fin de cuisson
- Verrouillage clavier
- Minuterie
- Indicateur de température
- Indicateur de préchauffage
- Verrouillage porte

• Touches

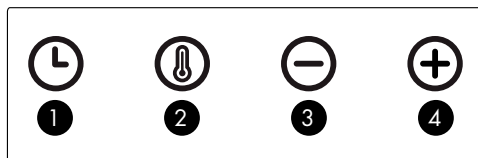

- 1** Réglage heure et durée
- 2** Réglage température
- 3** Touche -
- 4** Touche +



ACCESSOIRES

• Grille sécurité anti-basculement

La grille peut être utilisée pour supporter tous les plats et moules contenant des aliments à cuire ou à gratiner. Elle sera utilisée pour les grillades (à poser directement dessus).

Insérer la grille, sécurité anti-basculement vers le fond du four.

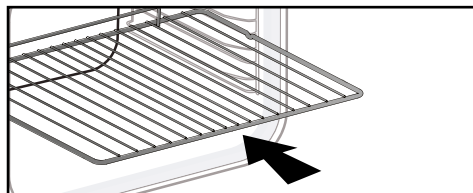

• Plat multi usages lèche-frites 45mm

A insérer dans les gradins sous la grille, poignée vers la porte du four. Il recueille les jus et les graisses des grillades, il peut être utilisé à demi rempli d'eau pour des cuissons au bain-marie.

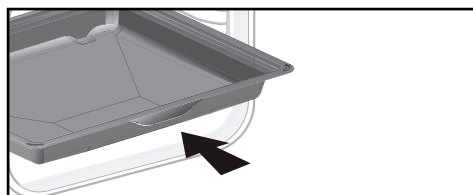

• Plat Pâtisserie 20mm

Inséré dans les gradins poignée vers la porte du four. Idéal pour la cuisson de cookies, sablés, cupcake. Son pan incliné vous permet de déposer facilement vos préparations dans un plat. Peut aussi être inséré dans les gradins sous la grille, pour recueillir les jus et les graisses des grillades.

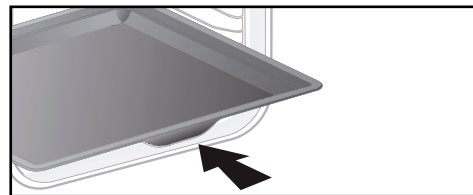

• Système de rails coulissants

Grâce au système de rails coulissants, la manipulation des aliments devient plus pratique et facile puisque les plaques peuvent être sorties en douceur, ce qui simplifie au maximum leur manipulation. Les plaques peuvent être extraites entièrement, ce qui permet d'y accéder totalement. De plus, leur stabilité permet de travailler et de manipuler les aliments en toute sécurité, ce qui réduit le risque de brûlures. Ainsi, vous pouvez sortir vos aliments du four beaucoup plus aisément.

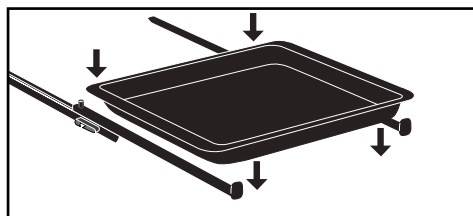

Mise en garde :

Retirez les accessoires et les gradins du four avant de démarrer un nettoyage par pyrolyse.

Mise en garde :

Sous l'effet de la chaleur les accessoires peuvent se déformer sans que cela n'altère leur fonction. Ils reprennent leur forme d'origine une fois refroidis.



Présentation de votre appareil

INSTALLATION ET DEMONTAGE DES RAILS COULISSANTS

Après avoir retiré les 2 gradins-fils, choisissez la hauteur de gradins (de 2 à 5) à laquelle vous souhaitez fixer vos rails. Enclenchez le rail gauche contre le gradin gauche en effectuant une pression suffisante à l'avant et à l'arrière du rail afin que les 2 pattes sur le côté du rail rentrent dans le gradin-fil. Procédez de la même façon pour le rail droit.

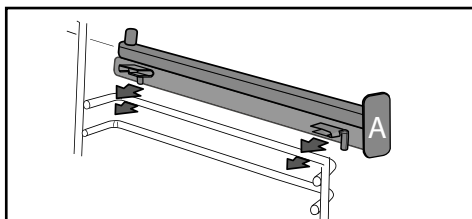

NOTA : la partie coulissante télescopique du rail doit se déplier vers l'avant du four, la butée **A** se trouve face à vous.

Mettez en place vos 2 gradins-fils et posez ensuite votre plaque sur les 2 rails, le système est prêt à l'utilisation.

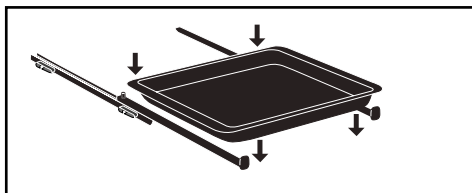

Pour démonter les rails, retirez à nouveau les gradins-fils.

Ecartez légèrement vers le bas les pattes fixées sur chaque rail pour les libérer du gradin. Tirez le rail vers vous.

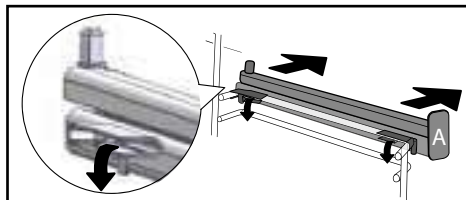

Conseil :

Afin d'éviter le dégagement de fumées durant la cuisson de viandes grasses, nous vous recommandons d'ajouter une faible quantité d'eau ou d'huile au fond de la lèche-frites.





Utilisation de votre appareil

RÉGLAGES

• Mise à l'heure

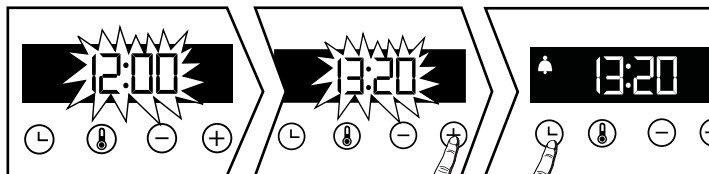
A la mise sous tension l'afficheur clignote à 12:00.





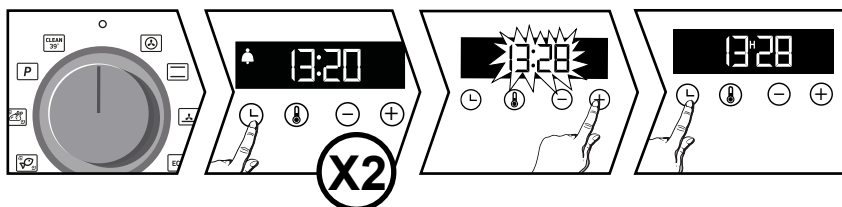

Réglez l'heure avec les touches + ou -. Validez avec la touche . En cas de coupure de courant l'heure clignote.

• Modification de l'heure

Le sélecteur de fonction doit obligatoirement être sur la position 0.





Appuyez sur la touche  le symbole  apparaît appuyez de nouveau sur . Ajustez le réglage de l'heure avec les touches + ou -. Validez avec la touche . L'enregistrement, de l'heure ajustée est automatique, au bout de quelques secondes.

• Minuterie

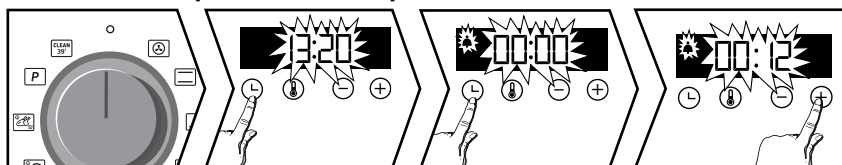
Cette fonction ne peut être utilisée que four à l'arrêt.



Le sélecteur de fonction doit obligatoirement être sur la position 0.



Appuyez sur la touche  le symbole  apparaît. Ajustez le réglage de l'heure avec les touches + ou -. Validez avec la touche .

NB : Vous avez la possibilité de modifier ou d'annuler la programmation de la minuterie à n'importe quel moment. Pour annuler, retournez au menu de la minuterie et réglez sur 00:00. Sans validation, l'enregistrement s'effectue automatiquement au bout de quelques secondes.

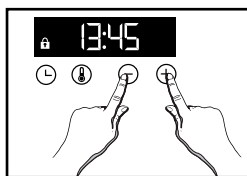

• Verrouillage clavier (sécurité enfants)





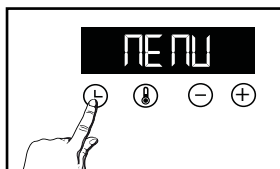

Appuyez simultanément sur les touches + et - jusqu'à l'affichage du symbole  à l'écran. Pour le déverrouiller, simultanément sur les touches + et - jusqu'à ce que le symbole  disparaisse de l'écran.

MENU RÉGLAGES

Vous pouvez intervenir sur différents paramètres de votre four, pour cela: Appuyez sur la touche  jusqu'à l'affichage de "MENU" pour accéder au mode de réglage.



Appuyez de nouveau sur la touche  afin de faire défiler les différents réglages. Activez ou désactivez avec les touches + et - les différents paramètres, voir tableau ci-après:

	AUTO: En mode cuisson la lampe de la cavité s'éteint au bout de 90 secondes ON: En mode cuisson la lampe est tous le temps allumé.
	Activez/désactivez les bips des touches
	Activez/désactivez le mode préchauffage
	Activez/désactivez le mode démonstration

Pour sortir du "MENU" appuyez de nouveau sur .



Utilisation de votre appareil

MODES DE CUISSON

Fonctions manuelles :



CHALEUR TOURNANTE*

Température mini 35°C maxi 250°C

Recommandé pour garder le moelleux des viandes blanches, poissons, légumes. Pour les cuissons multiples jusqu'à 3 niveaux.



TRADITIONNEL

Température mini 35°C maxi 275°C

Recommandé pour les cuissons lentes et délicates: gibiers moelleux. Pour saisir rôtis de viande rouge. Pour mijoter en cocotte fermée des plats préalablement démarrés sur table de cuisson (coq au vin, civet).



SOLE PULSÉ

(température mini 75°C maxi 250°C)

Recommandé pour les plats humides (quiches, tartes aux fruits juteux...). La pâte sera bien cuite dessous. Recommandé pour les préparations qui lèvent (cake, brioche, kouglof...) et pour les soufflés qui ne seront pas bloqués par une croûte dessus.



ECO*

Température mini 35°C maxi 275°C

Cette position permet de faire un gain d'énergie tout en conservant les qualités de cuisson.

Toutes les cuissons se font sans préchauffage.



GRIL FORT

Température mini 180°C maxi 275°C

Recommandée pour griller des toasts, gratiner un plat, dorer une crème brûlée...



GRIL PULSE

Température mini 100°C maxi 250°C

Volailles et rôtis juteux et croustillants sur toutes les faces.

Glissez la lèchefrite au gradin du bas.

Recommandé pour toutes les volailles ou rôtis, pour saisir et cuire à coeur gigot, côtes de boeuf. Pour garder leur fondant aux pavés de poissons.

Fonctions automatiques :

Brandt vous propose 3 nouvelles fonctions qui combinent, de façon automatique, deux modes de cuisson : la cuisson traditionnelle et la cuisson vapeur afin de préserver les qualités nutritionnelles des aliments et d'obtenir une cuisson plus rapide.



VIANDES BLANCHES

Recommandé pour conserver le moelleux et le fondant des rôtis de porc et de veau.



POISSONS

Recommandé pour la cuisson des poissons entiers ou en filets.



VOLAILLES

Recommandé pour la cuisson des poulets, dindes, pintades et canards.

Pour ces 3 fonctions il vous suffit d'introduire de l'eau tiède en quantité suffisante dans votre plat (lèchefrite) et de le positionner dans votre four au gradin du bas et votre aliment à cuire au gradin niveau 3.

Concernant la quantité d'eau à introduire dans la lèchefrite, reportez-vous au tableau des fonctions combinées automatiques avec association de vapeur en fin de notice.



Système "Smart Assist"

Votre four est équipé de la fonction "Smart Assist" qui lors d'une programmation de durée, vous préconisera une durée de cuisson modifiable selon le mode de cuisson choisi.

**Mode de cuisson réalisé selon les prescriptions de la norme EN 60350-1 : 2016 pour démontrer la conformité aux exigences d'étiquetage énergétique du règlement européen UE/65/2014.*



Utilisation de votre appareil

DÉMARRAGE D'UNE CUISSON

• Démarrage d'une cuisson immédiate

Le programmateur ne doit afficher que l'heure. Celle-ci ne doit pas clignoter. Tournez le sélecteur de fonctions sur la position de votre choix.

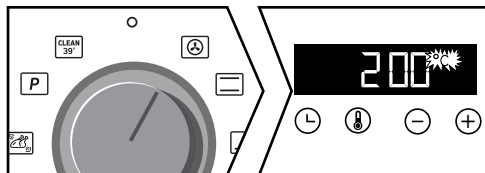



Pour les fonctions manuelles :

La montée en température démarre immédiatement. Votre four vous préconise une température, modifiable. Le four chauffe et l'indicateur de température clignote. Une série de bips sonores retentit lorsque le four atteint la température programmée.

Pour les fonctions automatiques :

 s'affiche à l'écran.

Sélectionnez votre aliment à l'aide du tableau en fin de notice. Appuyez sur les touches + et - jusqu'à obtenir le schéma souhaité dans l'afficheur puis validez avec la touche .

Un poids clignote ; rentrez le poids réel de votre aliment avec les touches + et - puis validez .

Vous n'avez rien d'autre à régler, la température et la durée de cuisson sont calculées automatiquement. L'heure de fin de cuisson clignote, validez avec la touche . Votre cuisson démarre aussitôt.



• Modification de la température

Appuyez sur .

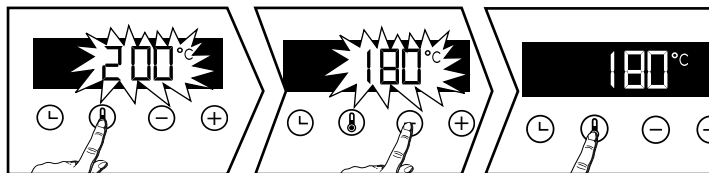
Ajustez la température avec + ou -.Validez en appuyant sur .



• Modification de la durée

Effectuez une cuisson immédiate ensuite appuyez sur , la durée de cuisson  clignote, le réglage est alors possible. Appuyez sur + ou - pour régler la durée de cuisson.

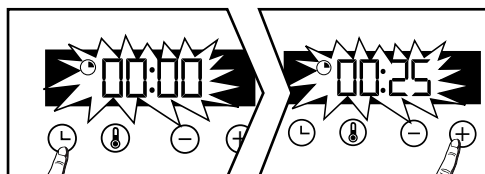





Système "Smart Assist"

Votre four est équipé de la fonction "Smart Assist" qui lors d'une programmation de durée, vous préconisera une durée de cuisson modifiable selon le mode de cuisson choisi (voir tableau).

L'enregistrement du temps de cuisson est automatique au bout de quelques secondes. Le décompte de la durée se fait immédiatement une fois la température de cuisson atteinte.

FONCTION DE CUISSON	DURÉE
	30 min
	30 min
	30 min
	30 min
	7 min
	15 min

• Modification de l'heure de fin de cuisson

Procédez comme une durée programmée. Après le réglage de la durée de cuisson, appuyez sur la touche , l'heure de fin de cuisson  clignote.

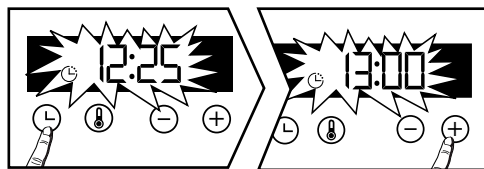

L'affichage clignote, réglez l'heure de fin de cuisson avec + ou -.

L'enregistrement de la fin de cuisson est automatique au bout de quelques secondes. L'affichage de la fin de cuisson ne clignote plus.



NETTOYAGE INTÉRIEUR - EXTÉRIEUR

• Nettoyage de la cavité par pyrolyse





Attention

Retirez les accessoires et les gradins-fils du four avant de démarrer un nettoyage par pyrolyse. Avant de procéder à un nettoyage pyrolyse de votre four, enlevez les débordements importants qui auraient pu se produire. Enlevez le surplus de graisse sur la porte à l'aide d'une éponge humide.

Par mesure de sécurité, l'opération de nettoyage par pyrolyse ne s'effectue qu'après blocage automatique de la porte, il est impossible de déverrouiller la porte.

• Autonettoyage immédiat

Le programmeur doit afficher l'heure du jour, sans clignoter. Sélectionnez un des cycles d'autonettoyage avec la manette de fonctions  ou  :

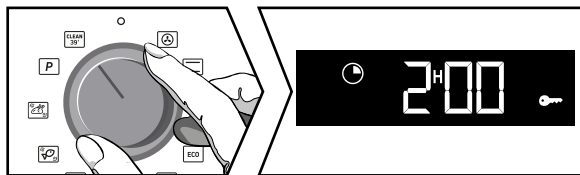





= Nettoyage en 39 minutes

- A chaque fin de cuisson «Clean 39» défile à l'écran vous proposant de lancer ce nettoyage. Positionnez la manette sur cette fonction et validez avec la touche . La durée 0:39 s'affiche en alternance avec «Clean 39», votre nettoyage démarre. Au bout de quelques minutes une clé apparaît, la porte du four est alors verrouillée automatiquement par mesure de sécurité durant tout le programme.

Si vous souhaitez lancer un «Clean 39» four froid ou pas suffisamment chaud, les conditions de lancement du programme ne permettront pas ce nettoyage. 0:00 s'affichera à l'écran, vous devrez alors choisir l'autre position d'autonettoyage .

= Pyrolyse de 2 heures ou d'1 heure 30, au choix. Positionnez la manette sur cette fonction.



Positionnez la manette sur cette fonction.  s'affiche à l'écran. Appuyez sur + pour choisir votre pyrolyse en fonction du degré de salissure de votre four.

Selon votre choix, la durée 2:00 (ou 1:30) s'affiche. Validez avec la touche .  (ou ) s'affiche, la pyrolyse démarre.

A la fin du nettoyage l'afficheur indique 0:00 et la porte se déverrouille.

Ramenez le sélecteur de fonctions sur 0.

• Autonettoyage différée

Vous avez la possibilité de différer le départ de votre Pyrolyse. Lorsque la durée du programme s'affiche à l'écran, appuyez sur la touche  et réglez la nouvelle heure de fin avec les touches + et - puis validez avec . L'autonettoyage commencera ultérieurement pour terminer à la nouvelle heure programmée. Remettez le sélecteur de fonctions sur 0 à la fin du nettoyage.



Entretien de votre appareil

• Nettoyage de la surface extérieure

Utilisez un chiffon doux, imbibé de produit à vitre. N'utilisez pas de crèmes à récurer, ni d'éponge grattoir.

• Nettoyage des gradins-fils

Démontez les gradins-fils pour les nettoyer. Soulevez la partie avant du gradin vers le haut ; poussez l'ensemble du gradin et faites sortir le crochet avant de son logement. Tirez ensuite légèrement l'ensemble du gradin vers vous afin de faire sortir les crochets arrières de leur logement. Retirez ainsi les 2 gradins.

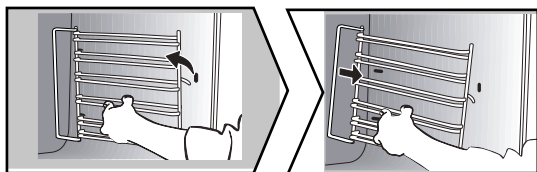

• Nettoyage des vitres de la porte

Attention :

Ne pas utiliser de produits d'entretien à récurer, d'éponge abrasive ou de grattoirs métalliques pour nettoyer la porte en verre du four, ce qui pourrait érafler la surface et entraîner l'éclatement du verre.

Au préalable enlevez avec un chiffon doux et du liquide vaisselle le surplus de graisse sur la vitre intérieure.

Pour nettoyer les différentes vitres intérieures, procédez au démontage de celles-ci de la façon suivante :

• Nettoyage des vitres de la porte

Ouvrez complètement la porte et bloquez-la à l'aide de la câle plastique fournie dans la pochette plastique de votre appareil.

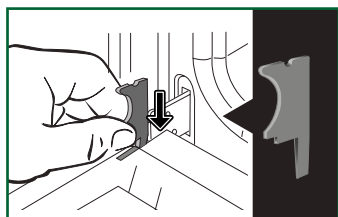

Retirez la première vitre clipée : appuyez à l'aide d'un outil (tournevis) dans les emplacements (A) afin de décliper la vitre puis retirez-la.

Important :

Veillez à bien repérer le sens de montage de cette 1ère vitre (face brillante vers vous)



Entretien de votre appareil

Selon modèle la porte est composée de deux vitres supplémentaires avec à chaque coin une entretoise noire en caoutchouc. Si nécessaire, retirez-les pour les nettoyer.

Ne pas immerger les vitres dans l'eau. Rincez à l'eau claire et essuyez avec un chiffon non pelucheux.

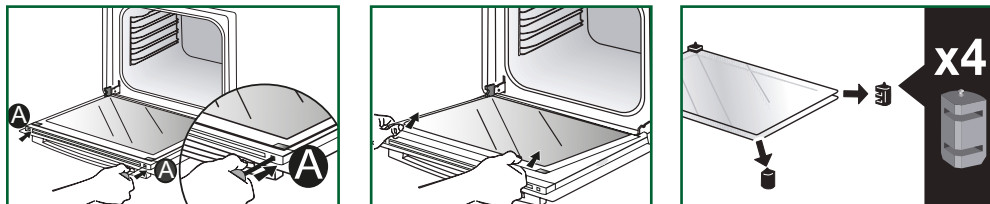

• Remontage des vitres de la porte

Après nettoyage, repositionnez les quatre butées en caoutchouc flèche vers le haut et repositionnez l'ensemble des vitres.

Engagez la dernière vitre dans les butées métalliques, ensuite clippez-la, face brillante vers vous. Retirez la câle plastique.

Votre appareil est de nouveau opérationnel.

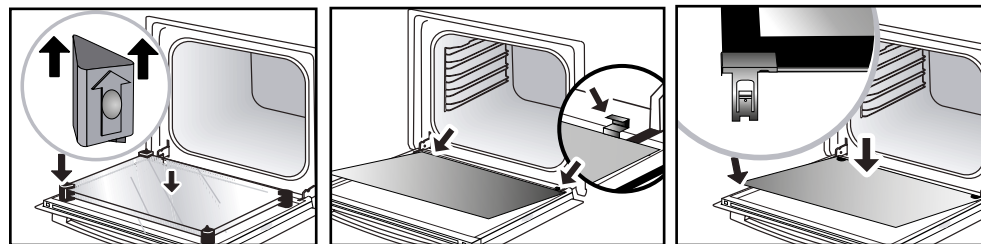

• Remplacement de la lampe

 **Important :**
Assurez-vous que l'appareil est déconnecté de l'alimentation avant de remplacer la lampe pour éviter tout risque de choc électrique. Intervenez lorsque l'appareil est refroidi.

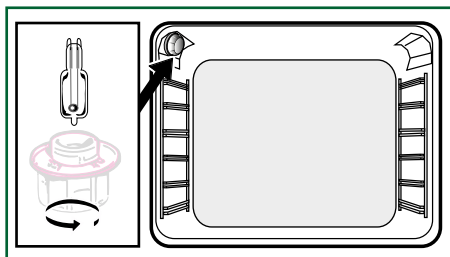

Caractéristiques de l'ampoule :

25 W, 220-240 V~, 300°C, culot G9.

Vous pouvez remplacer vous-même la lampe lorsqu'elle ne fonctionne plus. Dévissez le hublot puis sortez la lampe (utilisez un gant de caoutchouc qui facilitera le démontage). Insérez la nouvelle lampe et remplacez le hublot.



ANOMALIES ET SOLUTIONS

Le four ne chauffe pas.

Vérifiez si le four est bien branché ou si le fusible de votre installation n'est pas hors service. Augmentez la température sélectionnée.

La lampe du four ne fonctionne pas.

Remplacez l'ampoule ou le fusible. Vérifiez si le four est bien branché.

Le ventilateur de refroidissement continue de tourner à l'arrêt du four.

C'est normal, la ventilation peut fonctionner jusqu'à une heure maxi après la cuisson pour faire baisser la température intérieure et extérieure du four. Au-delà d'une heure, contactez le Service Après Vente.

Le nettoyage par pyrolyse ne se fait pas.

Vérifiez la fermeture de la porte. Il peut s'agir d'un défaut de verrouillage de la porte ou du capteur de température. Si le défaut persiste, contactez le Service Après-Vente.

Le symbole clignote dans l'afficheur.

Défaut de verrouillage de la porte, faites appel au Service Après Vente.

Bruit de vibration.

Vérifiez que le cordon d'alimentation ne soit pas en contact avec la paroi arrière.

Ceci n'a pas d'impact sur le bon fonctionnement de votre appareil mais peut néanmoins générer un bruit de vibration pendant la ventilation. Retirez votre appareil et déplacez le cordon. Remplacez votre four.



Service après-vente

INTERVENTIONS

Les éventuelles interventions sur votre appareil doivent être effectuées par un professionnel qualifié dépositaire de la marque. Lors de votre appel, afin de faciliter la prise en charge de votre demande, munissez-vous des références complètes de votre appareil (référence commerciale, référence service, numéro de série). Ces renseignements figurent sur la plaque signalétique.

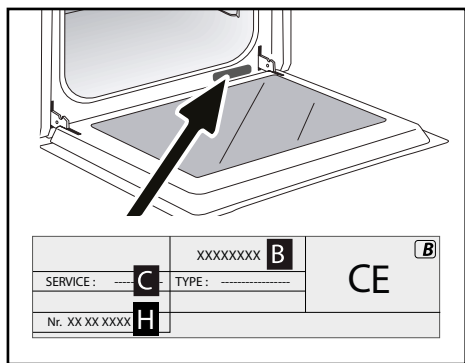

- B : Référence commerciale
- C : Référence service
- H : Numéro de série

Vous pouvez nous contacter du lundi au samedi de 8h00 à 20h00 au :

09 69 39 25 25

Service gratuit + prix appel

RELATIONS CONSOMMATEURS

Pour en savoir plus sur nos produits, vous pouvez consulter notre site : www.brandt.com

vous pouvez nous contacter :

> Via notre site, www.brandt.com rubrique «SERVICES».

> Par e-mail à l'adresse suivante : relations.consommateurs@groupebrandt.com

>nous écrire à l'adresse postale suivante :
Service Consommateurs BRANDT
5 avenue des Béthunes
CS69526 SAINT OUEN L'AUMONE
95060 CERGY PONTOISE CEDEX

> Par téléphone du lundi au vendredi de 8h30 à 18h00 au :

0 892 02 88 01

Service 0,50 € / min + prix appel

PIÈCES D'ORIGINE

Lors d'une intervention, demandez l'utilisation exclusive de pièces détachées certifiées d'origine.





PLATS	* * * * * * *												min	
Viandes														
Rôti de porc (1kg)	200	2						180	2					60
Rôti de veau (1kg)	200	2						180	2					60-70
Rôti de boeuf	240	2												30-40
Agneau (gigot, épaule 2,5 kg)	220	1			220						200	2		60
Volailles (1 kg)	200	2			220		180	2			210	3		60
Volailles grosses pièces	180	1												60-90
Cuisses de poulet					220	3					210	3		20-30
Côtes de porc / veau					210	3								20-30
Côtes de boeuf (1kg)					210	3					210	3		20-30
Côtes de mouton					210	3								20-30
Poissons														
Poissons grillés					275	4								15-20
Poissons cuisinés	200	3					180	3						30-35
Poissons papillottes	220	3					200	3						15-20
Légumes														
Gratins (aliments cuits)					275	2								30
Gratins dauphinois	200	2					180	2						45
Lasagnes	200	3					180	3						45
Tomates farcies	170	3					160	2						30
Pâtisseries														
Biscuit de Savoie - Génoise			180	2							180	2		35
Biscuit roulé	220	3									180	2		5-10
Brioche	180	1	210								180	2		35-45
Brownies	180	2					175	3						20-25
Cake - Quatre-quarts	180	1	180	1							180	2		45-50
Clafoutis	200	2					180	3						30-35
Crèmes	165	2									150	2		30-40

* Selon modèle



PLATS	* * * * * * *											min		
Pâtisseries														
Cookies - Sablés	175	3										15-20		
Kugelhopf			180	2							180	2	40-45	
Meringues	100	2									100	3	60-70	
Madeleines	220	3					200	3					5-10	
Pâtes à choux	200	3					180	3				180	3	30-40
Petits fours feuilletés	220	3					200	3						5-10
Savarin	180	3										175	3	30-35
Tarte pâte Brisée	200	1					195	1						30-40
Tarte pâte feuilletée fine	215	1					200	1						20-25
Tarte pâte à levure	210	1					200	1						10-30
Divers														
Brochettes	220	3			210	4								10-15
Pâté en terrine	200	2					190	2						80-100
Pizza pâte Brisée	200	2												30-40
Pizza pâte à pain														15-18
Quiches														35-40
Soufflé												180	2	50
Tourtes	200	2												40-45
Pain	220						200		220					30-40
Pain grillé	180				275	4-5								2-3

* Selon modèle



Toutes les T°C et temps de cuisson sont donnés pour des fours préchauffés

N.B: Avant d'être mises au four, toutes les viandes doivent rester au moins 1 heure à température ambiante.

EQUIVALENCE : CHIFFRES T °C

°C	30	60	90	120	150	180	210	240	275
Chiffres	1	2	3	4	5	6	7	8	9 maxi



Recette avec levure (selon modèle)

Ingrédients:

● Farine 2 kg ● Eau 1240 ml ● Sel 40 g ● 4 paquets de levure de boulanger déshydratée

Mélanger la pâte avec le mixer et faire lever la pâte dans le four.





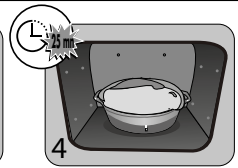
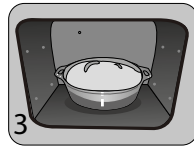
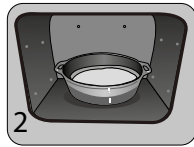
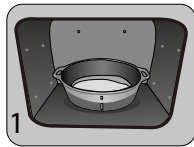













Procédure: Pour les recettes de pâtes à base de levure. Verser la pâte dans un plat résistant à la chaleur, retirer les supports de gradins fils et placer le plat sur la sole.

Préchauffez le four avec la fonction chaleur tournante à 40-50 °C pendant 5 minutes. Arrêtez le four et laissez lever la pâte 25-30 minutes grâce à la chaleur résiduelle.





ESSAIS D'APTITUDE A LA FONCTION SELON LA NORME CEI 60350













ALIMENT	*Mode de cuisson	NIVEAU	Accessoires	°C	DUREE min.	PRECHAUF-FAGE
Sablés (8.4.1)		5	plat 45 mm	150	30-40	oui
Sablés (8.4.1)		5	plat 45 mm	150	25-35	oui
Sablés (8.4.1)		2 + 5	plat 45 mm + grille	150	25-45	oui
Sablés (8.4.1)		3	plat 45 mm	175	25-35	oui
Sablés (8.4.1)		2 + 5	plat 45 mm + grille	160	30-40	oui
Petits cakes (8.4.2)		5	plat 45 mm	170	25-35	oui
Petits cakes (8.4.2)		5	plat 45 mm	170	25-35	oui
Petits cakes (8.4.2)		2 + 5	plat 45 mm + grille	170	20-40	oui
Petits cakes (8.4.2)		3	plat 45 mm	170	25-35	oui
Petits cakes (8.4.2)		2 + 5	plat 45 mm + grille	170	25-35	oui
Gâteau moelleux sans matière grasse (8.5.1)		4	grille	150	30-40	oui
Gâteau moelleux sans matière grasse (8.5.1)		4	grille	150	30-40	oui
Gâteau moelleux sans matière grasse (8.5.1)		2 + 5	plat 45 mm + grille	150	30-40	oui
Gâteau moelleux sans matière grasse (8.5.1)		3		150	30-40	oui
Gâteau moelleux sans matière grasse (8.5.1)		2 + 5	plat 45 mm + grille	150	30-40	oui
Tourte aux pommes (8.5.2)		1	grille	170	90-120	oui
Tourte aux pommes (8.5.2)		1	grille	170	90-120	oui
Tourte aux pommes (8.5.2)		3	grille	180	90-120	oui
Surface gratinée (9.2.2)		5	grille	275	3-6	oui

* Selon modèle

NOTA : Pour les cuissons à 2 niveaux, les plats peuvent être sortis à des temps différents.



TABLEAU DES FONCTIONS COMBINEES AUTOMATIQUES AVEC ASSOCIATION DE VAPEUR

Position de la manette	Affichage dans programmeur	Aliments	Quantité d'eau à ajouter
		Poulet	500 ml d'eau tiède dans la lèchefrite
		Canard	500 ml d'eau tiède dans la lèchefrite
		Dinde	500 ml d'eau tiède dans la lèchefrite
		Pintade	800 ml d'eau tiède dans la lèchefrite
		Poissons entiers (gros)	500 ml d'eau tiède dans la lèchefrite
		Poissons entiers (plats)	300 ml d'eau tiède dans la lèchefrite
		Petits poissons entiers	300 ml d'eau tiède dans la lèchefrite
		Filets de poissons	300 ml d'eau tiède dans la lèchefrite
		Rôti de porc	500 ml d'eau tiède dans la lèchefrite
		Rôti de veau	500 ml d'eau tiède dans la lèchefrite

IMPORTANT

Positionnez la lèchefrite (avec l'eau tiède) au gradin du bas, niveau 1 et votre aliment à cuire au gradin niveau 3.



EN	Información for domestic ovens (UE n° 662014)	DE	Informationen zu Haushaltsbacköfen (UE n° 662014)
FR	Informations concernant les fours domestiques (UE n° 662014)	ES	Información sobre los hornos domésticos (UE n° 662014)
CS	Informační údaje pro domácí troubu (UE n° 662014)	IT	Informazione relative ai forni per uso domestico (UE n° 662014)
DA	Oplysninger for ovne til husholdningsbrug (UE n° 662014)	NL	Informatie met betrekking tot huishoudelijke ovens (UE n° 662014)
EL	Πληροφορίες για οικιακά φούρνους (UE n° 662014)	FI	koteloitten uunien tiedot (UE n° 662014)

Symbol	Value	Unit	EN Symbol	FR Symbol	CS Symbol	DA Symbol	EL Symbol	ES Symbol	IT Symbol	DE Symbol	NL Symbol	FI Symbol
Type norme												
Models identification												
Type of oven												
Mass of the appliance	34,6 30,7 35,7 33,6 36,2 36,6 35,0 33,6 36,6 38,0 38,0 38,0 43,1	kg										
Number of cavities	1 1 1 1 1 1 1 1 1 1 1 1 1											
Heat source per cavity (type of fuel or gas)												
Volume per cavity	730 730 730 730 730 730 730 730 730 730 730 730 730	l										
Energy consumption (mode per cavity) required to heat a standardized load in a heated oven during a cycle in fan-forced mode per cavity (electric final energy)	0,82 0,82 0,68 0,70 0,70 0,70 0,70 0,70 0,70 0,70 0,70 0,70 0,70	kWh/cycle										
Energy consumption (mode per cavity) required to heat a standardized load in a heated oven during a cycle in conventional mode per cavity (electric final energy)												
Energy consumption (mode per cavity) required to heat a standardized load in a heated oven during a cycle in fan-forced mode per cavity (electric final energy)												
Energy efficiency index per cavity	90,3 86,3 80,2 81,4 81,4 81,4 81,4 81,4 81,4 81,4 81,4 81,4 81,4											

FR

CS

DA

DE

EL

EN

ES

FI

IT

NL

NO

PL

PT

SK

SV

Brandt



POKyny PRO UŽIVATELE CS

TROUBA

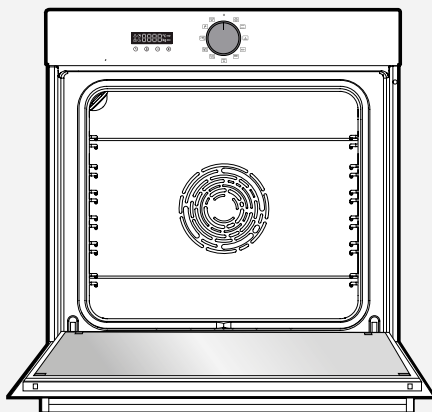

ORIGINE
FRANCE[®]
GARANTIE

BYCert.6011825

Vážený kliente,

Právě jste si zakoupili produkt **BRANDT** a děkujeme vám za důvěru v nás.

Tento produkt jsme navrhli a vyrobili s ohledem na vás, váš životní styl a vaše potřeby tak, aby nejlépe odpovídal vašim očekáváním. Vložili jsme naše know-how, našeho inovačního ducha a veškerou vášně, která nás poháněla více než 60 let.

V trvalém zájmu vždy lépe vyhovět vašim požadavkům je vám k dispozici náš zákaznický servis a můžete nám odpovědět na všechny vaše dotazy nebo návrhy.

Přihlaste se také na naší webové stránce **www.brandt.com**, kde najdete naše nejnovější inovace a užitečné a další informace.

Společnost **BRANDT** vás denně ráda podpoří a přeje si, abyste si nákup plně užili.

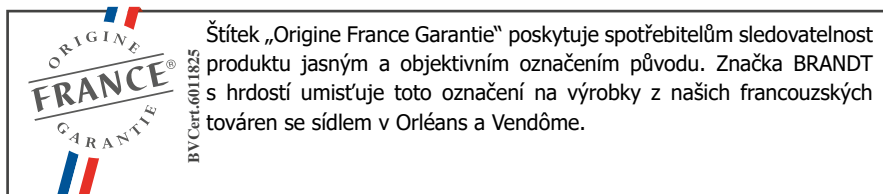

<https://brandt.fr/>

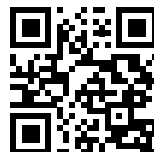

Důležité:

Před zapnutím zařízení si pečlivě přečtěte tuto příručku, abyste se mohli rychleji seznámit s jeho provozem.



Bezpečnostní pokyny	4
ŽIVOTNÍ PROSTŘEDÍ A ÚSPORA ENERGIE	6
Prostředí	6
Tip na úsporu energie	6
instalace spotřebiče	7
Volba umístění a instalace	7
Elektrické připojení	8
Popis vašeho spotřebiče	9
Prezentace trouby	9
Displej a ovládací tlačítka	9
Príslušenství	10
Používání zařízení	12
Nastavení	12
Nabídka nastavení	13
Režimy vaření	14
Zahájení vaření	15
Péče o zařízení	17
Čištění interiéru - exteriéru	18
Anomálie a řešení	19
Poprodejní servis	21
Intervence	21
PODPORA VAŘENÍ	21
Tabulky vaření	22
Recepty s droždím	24
Funkční zkoušky způsobilosti	25
Funkce s automatickou kombinovanou párou	26



POZORNĚ SI PŘEČTĚTE DŮLEŽITÉ BEZPEČNOSTNÍ POKYNY A UCHOVEJTE JE PRO BUDOUCÍ POUŽITÍ.

Tento návod je k dispozici ke stažení na internetových stránkách značky.

- Při převzetí spotřebič ihned vybalte nebo nechte vybalit. Zkontrolujte jeho celkový vzhled. Případné výhrady uveďte písemně na dodacím listu a jednu kopii si ponechte.
-
- Důležité upozornění:
 - Děti do 8 let věku a osoby s omezenými fyzickými, smyslovými nebo mentálními schopnostmi nebo osoby s nedostatečnou zkušeností či znalostmi mohou toto zařízení používat pouze tehdy, pokud jsou pod dohledem nebo obdrží předchozí informace o používání zařízení a pochopí případná rizika.
 -
 - — Děti si nesmějí hrát se zařízením. Postup čištění a údržby nesmí provádět děti bez dozoru.
 - — Dávejte pozor, aby si se spotřebičem nehrály děti.
-
- **VÝSTRAHA:**
 - — Přístroj a jeho dostupné části jsou při používání teplé. Dávejte pozor, abyste se nedotkli topných těles uvnitř trouby. Děti do 8 let věku musejí být udržovány v bezpečné vzdálenosti, nebo musejí být pod stálým dohledem.
 -
 - — Tento přístroj je zkonstruován pro vaření se zavřenými dveřmi.
 - — Než spustíte pyrolytické čištění trouby, vyjměte všechna příslušenství a setřete největší nečistoty.
 - — Během funkce čištění se mohou plochy zahřát více než při běžném použití.
 - Doporučujeme udržovat děti v bezpečné vzdálenosti.
 - — Nepoužívejte zařízení pro parní čištění.
 - — Na čištění skleněných dvířek trouby nepoužívejte abrazivní čisticí prostředky nebo tvrdé kovové škrabky, protože byste mohli poškrábat jejich povrch a sklo by mohlo prasknout.
 -



BEZPEČNOST A DŮLEŽITÁ VAROVÁNÍ

• VÝSTRAHA :

- Než budete měnit žárovku, ujistěte se, že je přístroj odpojen od napájení, abyste zabránili riziku úrazu elektrickým proudem. Úkon proveďte, až spotřebič vychladne. Pro odšroubování ochranného skla a žárovky použijte kaučukovou rukavici, která usnadní vy-montování.

- Elektrická zásuvka musí být po instalaci přístupná. Musí být umožněno odpojení spotřebiče od napájecí sítě, buď prostřednictvím zástrčky v elektrické zásuvce, anebo začleněním vypínače do pevných vedení v souladu s pravidly instalace.

- — Je-li kabel poškozený, musí jej z bezpečnostních důvodů vyměnit výrobce, jeho servisní oddělení nebo oprávněná osoba, aby se předešlo nebezpečí.

- — Tento přístroj může být instalován stejně tak pod plochou nebo na sloupku, jak je znázorněno na instalačním schématu.

- — Umístěte troubu do nábytku tak, aby byla zajištěna minimální vzdálenost 10 mm od sousedního kusu nábytku. Materiál nábytku, do kterého vestavíte troubu, musí být odolný vůči teplu (nebo musí být povrstvený takovým materiálem). Pro větší stabilitu upevněte troubu

2 šrouby, které zasunete do otvorů určených k tomu účelu.

- — Zařízení se nesmí instalovat za ozdobná dvířka, aby nedocházelo k přehřívání.

- — Toto zařízení je určeno pro použití v domácích a podobných prostředích, jako jsou kuchyňské kouty určené pro pracovníky obchodů, kanceláří a dalších profesionálních zařízení, farmy, používání u klientů v hotelích, motelích a dalších ubytovacích zařízeních, zařízení typu hostinských pokojů.

- — Při každém čištění vnitřních částí trouby musí být trouba vypnutá.

- Neměňte vlastnosti tohoto přístroje, mohlo by to být pro vás nebezpečné.

- Po použití nepoužívejte troubu jako spíž ani ke skladování žádných potřeb.



OCHRANA ŽIVOTNÍHO PROSTŘEDÍ



materiály tohoto spotřebiče jsou
elne. Podílejte se na jejich recyklaci
tak k ochraně životního prostředí.
je v příslušných kontejnerech
k tomu účelu.

Váš spotřebič obsahuje i mnoho
recyklovatelných materiálů. Je proto označen
tímto logem, které vám sděluje, že se
vyřazené spotřebiče nemají mísit s jiným
typem odpadů.

Recyklace spotřebičů, kterou zajišťuje
výrobce, se tak provádí za nejlepších
podmínek podle evropské směrnice 2002/96/
ES o odpadech z elektrických a elektronických
zařízení.

Obrat'te se na obecní úřad nebo na prodejce
a zeptejte se na umístění sběrných dvorů pro
použitá spotřebiče v blízkosti vašeho bydliště.
Děkujeme vám za spolupráci při ochraně
životního prostředí.

Tip na úsporu energie

Během vaření udržujte dvířka trouby zavřená.



VÝBĚR UMÍSTĚNÍ A VESTAVBA

Uvedená schémata stanovují kóty nábytku, do něž se trouba vejde.

Tento přístroj lze nainstalovat pod pracovní plochu (obr. A) nebo vertikálně (obr. B).
Pozor: Má-li nábytek otevřenou zadní stranu (pod pracovní plochou či při vertikální instalaci), mezi stěnou a prknem, na němž trouba leží, nesmí vzniknout prostor větší než 70 cm* (obr. C,D).

Vestavba spotřebiče. Sejměte gumové kryty a předvrtejte si v panelu nábytku otvory o průměru 2 mm, čímž se zamezí odštipnutí dřeva z nábytku. Upevněte troubu pomocí 2 šroubů. Vraťte gumové kryty na místo.



Doporučení

Abyste se ujistili, že je vaše instalace vyhovující, neváhejte se obrátit na odborníka v oboru domácích elektrospotřebičů.



Upozornění:

Pokud elektroinstalace vašeho bytu vyžaduje úpravu pro připojení přístroje, kontaktujte kvalifikovaného elektrikáře. Pokud trouba vykazuje jakoukoli poruchu, odpojte přístroj nebo vyjměte příslušnou pojistku z napájecího vedení trouby.

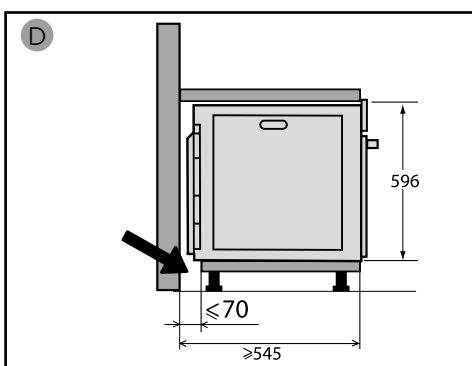
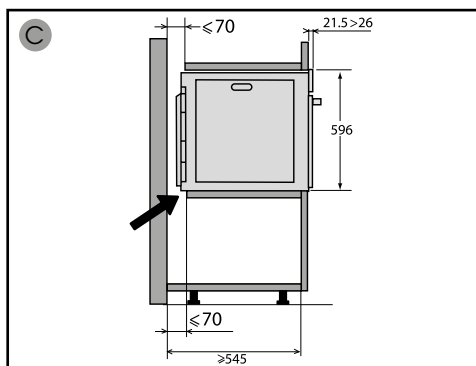
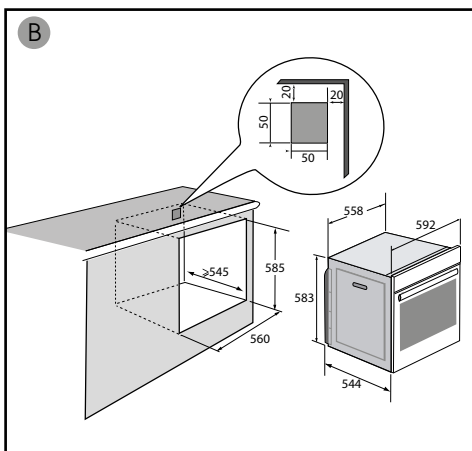
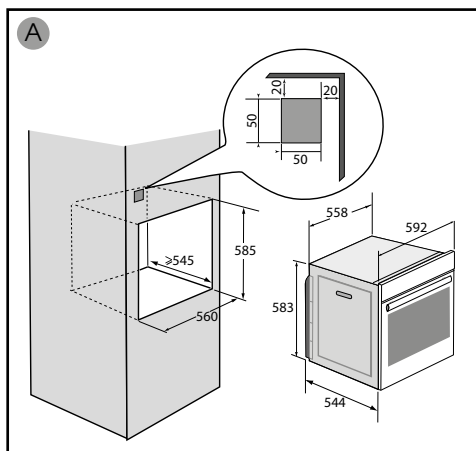



ELEKTRICKÉ PŘIPOJENÍ

Trouba musí být připojena standardním napájecím kabelem se 3 vodiči 1,5 mm² (1 ph + 1 N + uzemnění), který musí být připojen k síti 220 ~ 240 V přes zásuvku. Standard IEC 60083 nebo omnipolární odpojovací zařízení podle pravidla instalace.



Varování

Ochranný vodič (zeleno-žlutý) je připojen ke svorce zařízení a musí být připojen k zemi instalace. Instalační pojistka musí být 16 A.

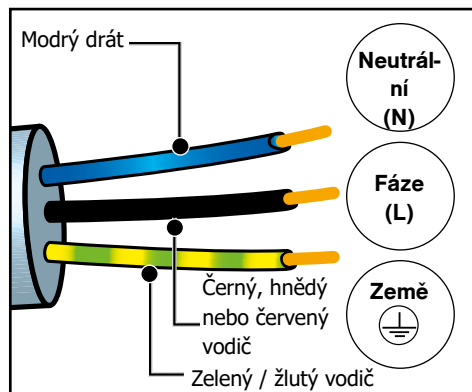

Nemůžeme nést odpovědnost v případě nehody nebo incidentu v důsledku neexistujícího, vadného nebo nesprávného uzemnění nebo v případě nesprávného připojení.

• Před prvním použitím

Před prvním použitím troubu zahřejte prázdnou, se zavřenými dvířky, asi 15 minut na nejvyšší teplotu. Za účelem vloupání do zařízení. Minerální vlna, která obklopuje dutinu pece, může zpočátku svým složením vydávat zvláštní zápach. Podobně si můžete všimnout kouře. To vše je normální.



Seznámení se zařízením

PREZENTACE TROUBY

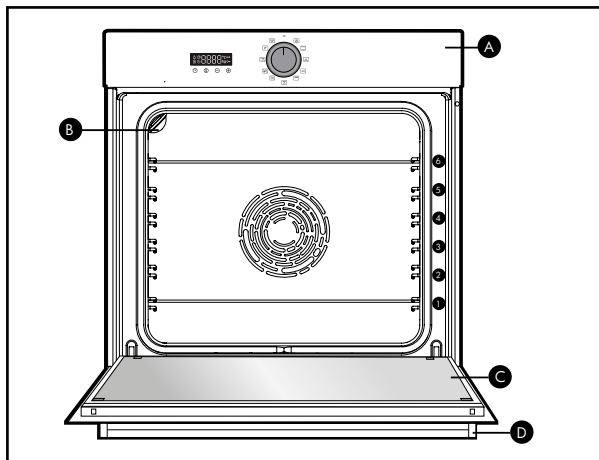

A Kontrolní panel

B Svítidla

C Dveře

D Rukojeť

Tato trouba má 6 pozic polic pro příslušenství: police 1 až 6.

• DISPLEJ



- Doba pečení
- Konec pečení
- Zamknutí tlačítek
- Minutka
- Ukazatel teploty
- Ukazatel předehřevu
- Zamčení dvířek

• TLAČÍTKA

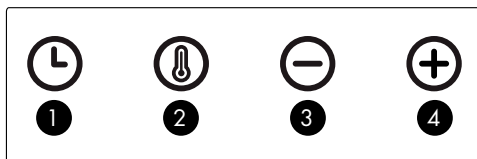

- 1** Nastavení času a doby
- 2** Nastavení teploty
- 3** Snížení hodnot
- 4** Zvýšení hodnot



PŘÍSLUŠENSTVÍ

• Rošt s pojistkou proti překlopení

Může být použit pro všechny plechy a formy s potravinami určenými k pečení nebo zapékání. Může se používat ke grilování (pokládat přímo na něj).

Zarážka proti překlopení musí směřovat k zadní části trouby.

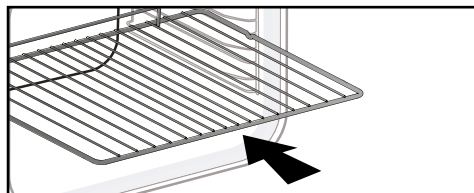

• Multifunkční odkapávací plech

45 mm

Vsouvá se do vodicích lišt pod rošt, rukojeť musí být obrácená ke dvířkům trouby. Zachytává šťávu a tuk při grilování; můžete ho také napustit do poloviny vodou a péct ve vodní lázni.

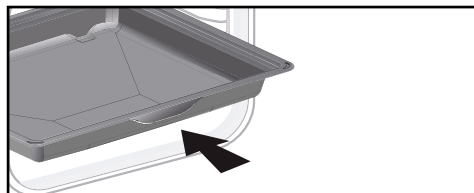

• Plech na pečení 20 mm

Vsouvá se do vodicích lišt, rukojeť musí být obrácená ke dvířkům trouby. Ideální na pečení sušenek, cukroví a dortíků. Jeho nakloněná plocha usnadňuje přesunutí jednotlivých kousků na podnos. Za účelem zachytávání šťávy a tuku při grilování jej lze rovněž vložit do vodicích lišt pod rošt.

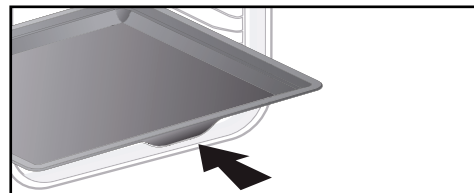

• Rošty pro šťavnatost

Poloviční rošty pro šťavnatost se používají nezávisle na sobě, ale vždy musí být položeny na jednom z plechů nebo na plechu pro zachytávání tuku s rukojetí proti překlopení obrácenou k zadní části trouby.

Použijete-li jen jeden rošt, můžete pokrmy snadno polévat šťávou nashromážděnou na plechu.

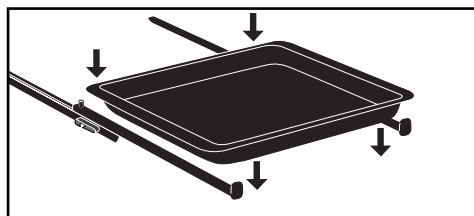

 **Než zahájíte čištění trouby pyrolýzou, vyjměte z ní veškeré příslušenství a vodicí lišty.**

 **Rada**

Aby se při pečení tučného masa předešlo uvolňování kouře, doporučujeme nalít na dno plechu pro zachycování tuku malé množství vody nebo oleje.



INSTALACE A DEMONTÁŽ POSUVNÉ TRATĚ

Po demontáži 2 schodových vodičů zvolte výšku schodů (od 2 do 5), ke kterým chcete upevnit kolejnice. Zaklapněte levou kolejnici proti levému kroku pomocí dostatečného tlaku na přední a zadní část kolejnice tak, aby 2 jazýčky na boku kolejnice zapadly do drátěné police. Stejným způsobem postupujte u pravé kolejnice.

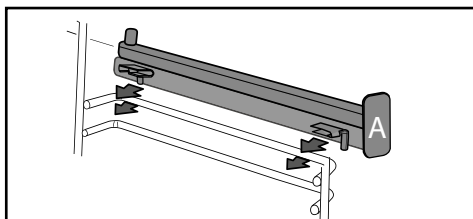

POZNÁMKA: teleskopická posuvná část kolejnice se musí rozvinout směrem k přední části trouby, stop A směrem k vám.

Umístěte 2 krokové vodiče na místo a poté položte desku na 2 kolejnice, systém je připraven k použití.

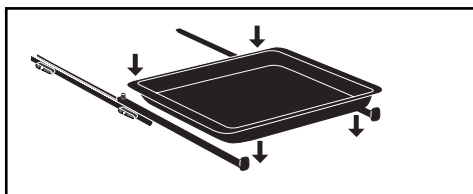

Chcete-li demontovat kolejnice, znovu odstraňte kabelové stupně. Mírně roztáhněte jazýčky připevněné ke každé kolejnici směrem dolů, abyste je uvolnili z kroku. Přitáhněte zábradlí k sobě.

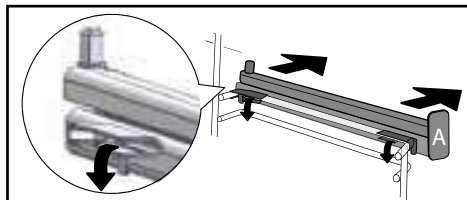

Rada :

Abyste zabránili uvolňování výparů při vaření tučného masa, doporučujeme přidat na dno pánve malé množství vody nebo oleje.





Používání zařízení

NASTAVENÍ

• NASTAVENÍ HODIN

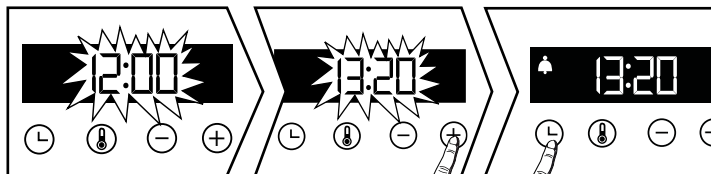
Po zapojení spotřebiče do elektrické sítě na displeji bliká 12:00.





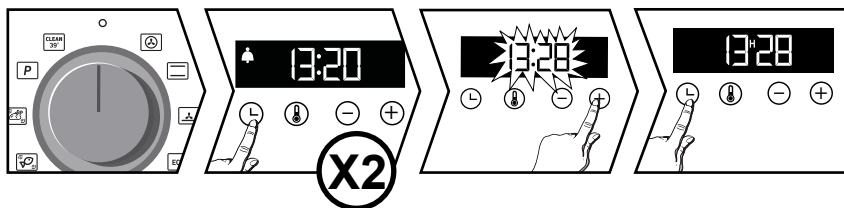

Hodiny nastavte pomocí tlačítek + a -. Výběr potvrďte stisknutím tlačítka . V případě výpadku dodávky elektrické energie časový údaj bliká.

• Změna času

Volič funkcí musí být v poloze 0.





Stiskněte klávesu  symbol  znovu stiskněte . Upravte nastavení času pomocí kláves + nebo -. Potvrďte tlačítkem . Záznam nastaveného času je automatický po několika sekundách.

• Časovač

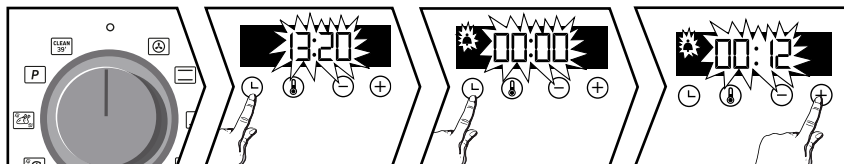
Tuto funkci lze použít, pouze když je trouba vypnutá



Volič funkcí musí být v poloze 0.



Stiskněte klávesu  symbol  Upravte nastavení času pomocí kláves + nebo -. Potvrďte tlačítkem .

Pozn.: Máte možnost kdykoli upravit nebo zrušit programování časovače. Pro zrušení se vraťte do nabídky časovače a nastavte na 00:00. Bez ověření dojde k záznamu automaticky po několika sekundách.

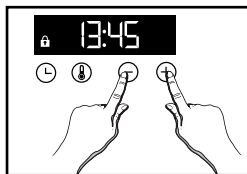

• Zámek klávesnice (dětská pojistka)





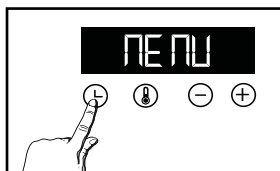

Současně stiskněte klávesy + a -, dokud se nezobrazí symbol  na obrazovce. Chcete-li jej odemknout, stiskněte současně klávesy + a -, dokud se nezobrazí symbol  z obrazovky.

NABÍDKA NASTAVENÍ

Můžete zasahovat do různých parametrů vaší trouby, jak to udělat: Stiskněte tlačítko  dokud se nezobrazí „MENU“ pro přístup do režimu nastavení.



Stiskněte znovu tlačítko  pro procházení různými nastaveními. Pomocí kláves + a - aktivujte nebo deaktivujte různé parametry, viz tabulka níže:

	AUTO: V režimu vaření zhasne lampa po 90 sekundách ZAPNUTO: V režimu vaření svítí kontrolka vždy.
	Aktivovat / deaktivovat pípnutí tlačítek
	Aktivace / deaktivace režimu předehřívání
	Aktivace / deaktivace demo režimu

Pro opuštění „MENU“ stiskněte znovu .



Používání zařízení

REŽIMY VAŘENÍ

RUČNÍ FUNKCE:



PROUDĚNÍ*

Teplota min. 35 ° C, max. 250 ° C

Doporučeno pro udržování vlhkého bílého masa, ryb, zeleniny. Pro vícenásobné vaření až na 3 úrovních.



TRADIČNÍ

Teplota min. 35 ° C, max. 275 ° C

Doporučeno pro pomalé a jemné vaření: měkká hra. K pečení pečeně z červeného masa. Pro vaření v uzavřeném kastrolu dříve zahájené pokrmy na varné desce (coq au vin, guláš).



PULSED SOIL

(minimální teplota 75 ° C, maximálně 250 ° C)

Doporučeno pro mokré pokrmy (quiche, šťavnatá ovocné koláče ...). Těsto bude zospodu dobře uvařené. Doporučeno pro kynutí (dort, brioška, kouglof ...) a pro suflé, které nebudou blokovány krustou.



ECO*

Teplota min. 35 ° C, max. 275 ° C

Tato poloha šetří energii při zachování kvality vaření.

Veškeré vaření probíhá bez předehřívání.



SILNÝ GRIL

Teplota min. 180 ° C, max. 275 ° C

Doporučeno pro grilování toastů, gratinování jídla, opečení krémového brúleee ...



PULZOVÝ GRIL

Teplota min. 100 ° C, maximálně 250 ° C

Šťavnatá a křupavá drůbež a pečeně ze všech stran.

Zasuňte odkapávací misku na spodní polici.

Doporučeno pro všechny drůbeže nebo pečeně, k opečení a vaření pečeného jehněčího, hovězího žebra. Aby si uchovali svůj fondán s finišery.

Automatické funkce:

Brandt vám nabízí 3 nové funkce, které automaticky kombinují dva režimy pečení: tradiční pečení a pečení s párou, aby byla uchována nutriční kvalita jídel a pečení bylo rychlejší.



BÍLÁ MASA

Doporučujeme pro zachování lahodnosti a křehkostivepřové a hovězí pečeně.



RYBY

Doporučujeme pro pečení celých ryb nebo rybích filetů.



DRŮBEŽ

Doporučujeme pro pečení kuřat, krůt, perliček a kachen.

U těchto 3 funkcí stačí nalít vlažnou vodu v dostatečném množství k vašeho pokrmu (do odkapávacího plechu) a umístit ho do trouby na spodní vodicí lišty a váš pokrm péct na vodicích lištách v úrovni 3.

Co se týče množství vody v odkapávacím plechu, podívejte se do tabulky kombinovaných automatických funkcí s použitím páry na konci návodu.



Systém „Smart Assist“

Vaše trouba je vybavena funkcí „Smart Assist“, která vám při programování doby trvání doporučí upravitelnou dobu pečení podle zvoleného režimu pečení.

** Metoda vaření prováděná podle požadavků normy EN 60350-1: 2016 k prokázání souladu s požadavky evropského nařízení EU / 65/2014 na energetické štítky.*



ZAHÁJENÍ VAŘENÍ

• Zahájení okamžitého vaření

Programátor by měl zobrazovat pouze čas. To by nemělo blikat.

Otočte volič funkcí do polohy podle vašeho výběru.

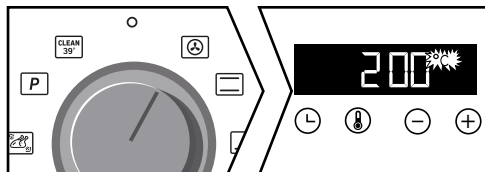

U manuálních funkcí:

Teplota se začne zvyšovat okamžitě. Trouba vám doporučí teplotu, kterou lze změnit. Trouba hřeje a ukazatel teploty bliká. Jakmile trouba dosáhne naprogramované teploty, ozvou se zvuková znamení.

U automatických funkcí:

 se zobrazí na displeji.

Vyberte vaše jídlo pomocí tabulky na konci návodu. Tiskněte tlačítka + a -, dokud se na displeji nezobrazí požadované schéma, pak potvrďte tlačítkem ☺.

Bliká váha; zadejte skutečnou váhu vašeho pokrmu pomocí tlačítek + a -, pak potvrďte ☺.

Nemusíte nic jiného nastavovat, teplota a délka pečení budou vypočítány automaticky. Bliká čas, kdy pečení skončí, potvrďte tlačítkem ☺. Pečení ihned započne.

• Změna teploty

Stiskněte ☺.

Upravte teplotu pomocí + nebo - Potvrďte stisknutím ☺.

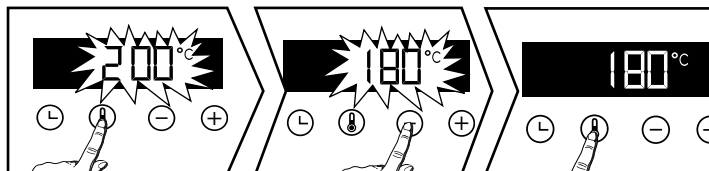

• Úprava doby trvání

Okamžitě vařte a poté stiskněte ☺, čas vaření ☺ bliká, nastavení je možné. Stisknutím + nebo - nastavte dobu vaření.

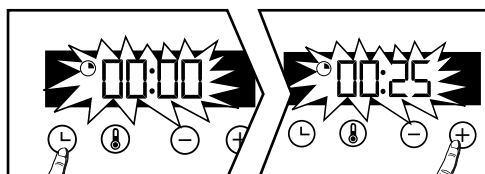





System „Smart Assist“

Vaše trouba je vybavena funkcí „Smart Assist“, která vám při programování doby trvání doporučí upravitelnou dobu vaření podle zvoleného režimu vaření (viz tabulka).

Doba vaření se automaticky uloží po několika sekundách. Čas se okamžitě odpočítává po dosažení teploty vaření.

FUNKCE VAŘENÍ	DOBA TRVÁNÍ
	30 min
	30 min
	30 min
ECO	30 min
	7 min
	15 min

• Změna konce doby vaření

Pokračujte jako naprogramovaná doba trvání. Po nastavení doby vaření stiskněte tlačítko , konec doby vaření  bliká.

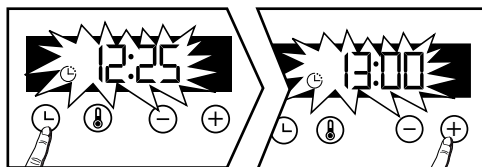

Displej bliká a pomocí + nebo - nastavte konec doby vaření. Konec vaření se automaticky zaznamená po několika sekundách. Displej konce vaření již neblinká.



INTERIÉR - ČIŠTĚNÍ EXTERIÉRU

• Čištění dutiny pyrolýzou



Pozor

Před čištěním pyrolýzou vyjměte z trouby příslušenství a posuvné lišty. Než spustíte pyrolytické čištění trouby, odstraňte z trouby větší připečené zbytky potravin. Odstraňte přebytečný tuk na dvířkách pomocí navlhčené houbičky.

V zájmu bezpečnosti může toto čištění probíhat pouze tehdy, jsou-li dvířka automaticky zablokována. Dvířka nelze otevřít.

• Okamžité samočištění

Na programové jednotce se musí zobrazit hodina bez blikání. Ovladačem funkcí zvolte jeden ze samočisticích cyklů nebo  :

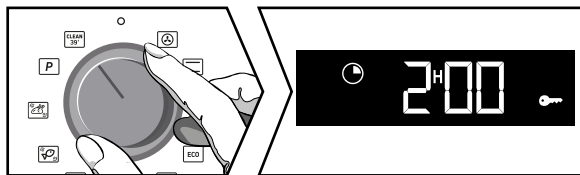



= Čištění 39 minut

- Na konci každého čištění na displeji probíhá nápis „Clean 39“, který nabízí spuštění tohoto čištění. Nastavte ovladač na tuto funkci a potvrďte tlačítkem . Střídavě s „Clean 39“ se začne zobrazovat doba 0:39 a čištění se spustí. Po několika minutách se objeví klíč, dvířka se tak automaticky z bezpečnostních důvodů po dobu tohoto programu uzamknou.

Pokud chcete spustit „Clean 39“, když je trouba studená nebo nedostatečně horká, podmínky pro spuštění tohoto programu čištění neumožní. 0:00 se zobrazí na displeji a vy si budete muset zvolit jinou polohu samočištění  .

= Volba pyrolýza 2 hodiny . Nastavte ovladač na tuto polohu.



Nastavte ovladač na tuto polohu.  se zobrazí na displeji. Stiskněte + pro volbu pyrolýzy v závislosti na stupni zašpinění trouby.

Podle vaší volby se zobrazí doba 2:00 . Potvrďte tlačítkem .  Zobrazí se , pyrolýza se spustí.

Na konci čištění se na displeji zobrazí 0:00 a dvířka se odemknou.

Vraťte tlačítko volby funkcí do polohy 0.

• Odložené samočištění

Spuštění pyrolýzy můžete odložit. Jakmile se na displeji zobrazí délka programu, stiskněte tlačítko  a nastavte novou hodinu skončení tlačítky + a -, pak potvrďte pomocí . Samočištění se spustí později tak, aby bylo ukončeno novou naprogramovanou hodinou. Po ukončení čištění nastavte volič funkcí na 0.



Péče o vaše zařízení

• Čištění vnějšího povrchu

oužijte měkký hadřík namočený v čističi oken. Nepoužívejte odmašťovací krémy nebo škrabky.

• Čištění drátěných stojanů

Demontujte krokové vodiče a očistěte je. Zvedněte přední část schůdku nahoru; zatlačte celý schod nahoru a uvolněte přední hák z jeho krytu. Poté lehce zatáhněte celý schod směrem k sobě, abyste uvolnili zadní háky z jejich krytu. Odstraňte 2 kroky.

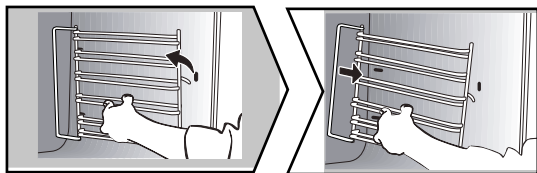

• Čištění skla dveří

Varování :

K čištění skleněných dvírek trouby nepoužívejte žádné drsné čisticí prostředky, brusné houby nebo kovové škrabky, které by mohly poškrábat povrch a rozbít sklo.

Nejprve odstraňte přebytečný tuk z vnitřního skla měkkým hadříkem a čisticím prostředkem. Chcete-li vyčistit různé vnitřní tabule, postupujte při jejich demontáži následujícím způsobem:

• Čištění skla dveří

Úplně otevřete dvířka a zablokujte je pomocí plastového klínu dodaného v plastovém pouzdře zařízení.

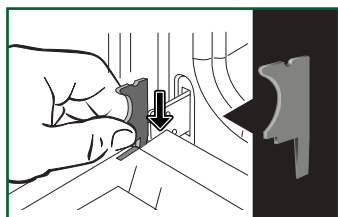

Odebrání prvního oříznutého podokna: stisknutím nástroje (šroubovák) v místech (A) odemkněte podokno a poté jej odeberte.

Důležité:

Ujistěte se, že jste označili směr montáže tohoto 1. okna (lesklá strana směrem k vám)



Péče o vaše zařízení

V závislosti na modelu jsou dveře tvořeny dvěma dalšími tabulemi s černou gumovou vložkou v každém rohu. Pokud je to nutné, vyjměte je kvůli čištění.

Neponořujte okna do vody. Opláchněte čistou vodou a osušte hadříkem, který nepouští vlákna.

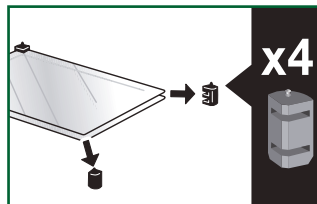
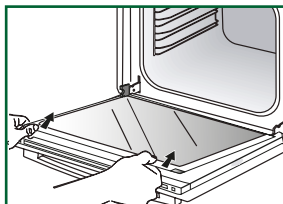
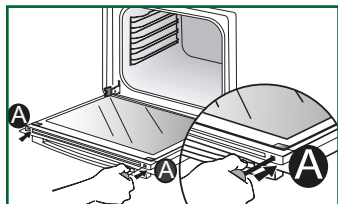

• Zpětná montáž oken dveří

Po vyčištění přemístěte čtyři gumové zářezky nahoru a přemístěte skleněnou sestavu.

Zapojte poslední panel do kovových zářezek, poté jej připeňte lesklou stranou směrem k sobě. Odstraňte plastový klín.

Vaše zařízení je opět funkční.

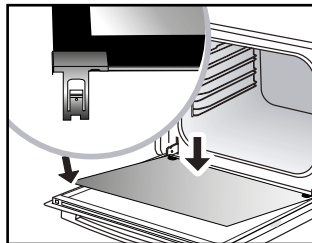
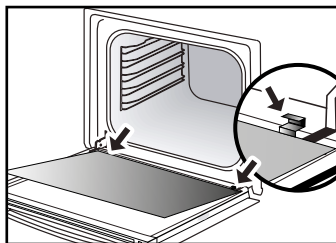
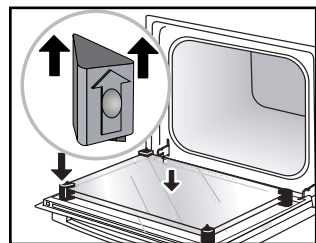

• Výměna lampy



Důležité:

Před výměnou lampy se ujistěte, že je zařízení odpojeno od zdroje napájení, aby nedošlo k úrazu elektrickým proudem. Jakmile zařízení vychladne, proveďte akci.

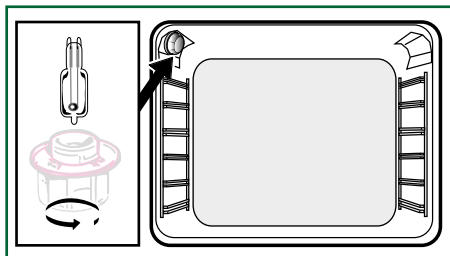

Vlastnosti žárovky:

25 W, 220-240 V~, 300°C, zadek G9.

Když lampa již nefunguje, můžete ji vyměnit sami. Odšroubujte okno a poté vyjměte lampu (použijte gumovou rukavici, která usnadní demontáž). Vložte novou lampu a vyměňte okno.



ANOMÁLIE A ŘEŠENÍ

Trouba se nezahřívá.

Zkontrolujte, zda je trouba správně připojená nebo zda nefunguje pojistka ve vaší instalaci. Zvyšte zvolenou teplotu.

Světlo trouby nefunguje.

Vyměňte žárovku nebo pojistku. Zkontrolujte, zda je trouba správně zapojena.

Chladicí ventilátor běží i po zastavení trouby.

To je normální, ventilace může fungovat až hodinu po vaření, aby se snížila vnitřní a vnější teplota trouby. Po uplynutí jedné hodiny kontaktujte poprodejní servis.

Čištění pyrolýzou se neprovádí.

Zkontrolujte, zda jsou dveře zavřené. Může to být chyba zámku dveří nebo snímače teploty. Pokud porucha přetrvává, kontaktujte poprodejní servis.

Symbol bliká na displeji.

Chyba zamykání dveří, volejte poprodejní servis. .

Vibrační hluk.

Zkontrolujte, zda napájecí kabel není v kontaktu se zadní stěnou.

To nemá žádný dopad na správnou funkci vašeho zařízení, přesto může během ventilace generovat vibrační zvuk. Vyjměte zařízení a přesuňte kabel. Vyměňte troubu.



ZÁSAHY

Veškeré práce na vašem zařízení musí provádět kvalifikovaný odborník, který je registrovaným držitelem ochranné známky. Když voláte, pro usnadnění vyřízení vaší žádosti mějte k dispozici úplné reference o vašem zařízení (komerční reference, servisní reference, sériové číslo). Tyto informace najdete na typovém štítku.

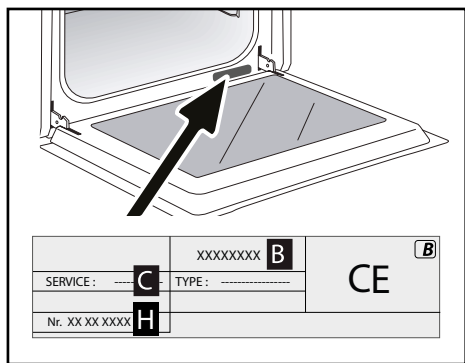

- B: Obchodní reference
- C: Reference služby
- H: Sériové číslo

ORIGINÁLNÍ DÍLY Během zásahu si vyžádejte výlučné použití certifikovaných originálních náhradních dílů.





NÁDOBÍ	* * * * * * * *																
Maso																	
Rôti de porc (1kg)	200	2							180	2							60
Rôti de veau (1kg)	200	2						180	2								60-70
Rôti de boeuf	240	2															30-40
Agneau (gigot, épaule 2,5 kg)	220	1			220							200	2				60
Volailles (1 kg)	200	2			220		180	2				210	3				60
Volailles grosses pièces	180	1															60-90
Cuisses de poulet					220	3						210	3				20-30
Côtes de porc / veau					210	3											20-30
Côtes de boeuf (1kg)					210	3						210	3				20-30
Côtes de mouton					210	3											20-30
Ryby																	
Poissons grillés					275	4											15-20
Poissons cuisinés	200	3					180	3									30-35
Poissons papillottes	220	3					200	3									15-20
Zelenina																	
Gratins (aliments cuits)					275	2											30
Gratins dauphinois	200	2					180	2									45
Lasagnes	200	3					180	3									45
Tomates farcies	170	3					160	2									30
Pečivo																	
Biscuit de Savoie - Génoise			180	2								180	2				35
Biscuit roulé	220	3										180	2				5-10
Brioche	180	1	210									180	2				35-45
Brownies	180	2					175	3									20-25
Cake - Quatre-quarts	180	1	180	1								180	2				45-50
Clafoutis	200	2					180	3									30-35
Crèmes	165	2										150	2				30-40

* V závislosti na modelu



NÁDOBÍ										min

Pečivo

Cookies - Sablés	175	3																	15-20	
Kugelhopf			180	2														180	2	40-45
Meringues	100	2																100	3	60-70
Madeleines	220	3						200	3											5-10
Pâtes à choux	200	3						180	3									180	3	30-40
Petits fours feuilletés	220	3						200	3											5-10
Savarin	180	3																175	3	30-35
Tarte pâte brisée	200	1						195	1											30-40
Tarte pâte feuilletée fine	215	1						200	1											20-25
Tarte pâte à levure	210	1						200	1											10-30

Rozličný

Brochettes	220	3			210	4														10-15
Pâté en terrine	200	2						190	2											80-100
Pizza pâte brisée	200	2																		30-40
Pizza pâte à pain																				15-18
Quiches																				35-40
Soufflé																		180	2	50
Tourtes	200	2																		40-45
Pain	220							200		220										30-40
Pain grillé	180				275	4-5														2-3

*** V závislosti na modelu****Všechny TIC a doby vaření jsou uvedeny pro předehřáté**

ozn .: Před vložením do pece musí všechno maso zůstat při pokojové teplotě po dobu alespoň 1 hodiny.

ROVNOCEMNOST: OBRÁZKY T °C

°C	30	60	90	120	150	180	210	240	275
Čísla	1	2	3	4	5	6	7	8	9 maxi



Recept na droždí (v závislosti na modelu)

Složení:

- Mouka 2 kg • Voda 1240 ml • Sůl 40 g • 4 balíčky dehydratovaných pekařských kvasnic
- Těsto promíchejte mixérem a nechte těsto v troubě vykynout.

Postup: Pro recepty na těstoviny založené na kvasnicích. Nalijte těsto do odolné nádoby ohřejte, vyjměte podpěry roštu a položte misku na dno.

Přehřejte troubu s funkcí horkého vzduchu na 40-50 ° C po dobu 5 minut. Vypněte troubu a nechte těsto 25-30 minut kynout zbytkovým teplem.

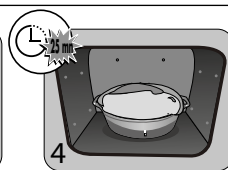



FUNKČNÍ ZKOUŠKY VHODNOSTI DLE IEC 60350

ALIMENT	*Mode de cuisson	NIVEAU	Accessoires	°C	DUREE min.	PRECHAUF-FAGE
Sablés (8.4.1)		5	plat 45 mm	150	30-40	oui
Sablés (8.4.1)		5	plat 45 mm	150	25-35	oui
Sablés (8.4.1)		2 + 5	plat 45 mm + grille	150	25-45	oui
Sablés (8.4.1)		3	plat 45 mm	175	25-35	oui
Sablés (8.4.1)		2 + 5	plat 45 mm + grille	160	30-40	oui
Petits cakes (8.4.2)		5	plat 45 mm	170	25-35	oui
Petits cakes (8.4.2)		5	plat 45 mm	170	25-35	oui
Petits cakes (8.4.2)		2 + 5	plat 45 mm + grille	170	20-40	oui
Petits cakes (8.4.2)		3	plat 45 mm	170	25-35	oui
Petits cakes (8.4.2)		2 + 5	plat 45 mm + grille	170	25-35	oui
Gâteau moelleux sans matière grasse (8.5.1)		4	grille	150	30-40	oui
Gâteau moelleux sans matière grasse (8.5.1)		4	grille	150	30-40	oui
Gâteau moelleux sans matière grasse (8.5.1)		2 + 5	plat 45 mm + grille	150	30-40	oui
Gâteau moelleux sans matière grasse (8.5.1)		3		150	30-40	oui
Gâteau moelleux sans matière grasse (8.5.1)		2 + 5	plat 45 mm + grille	150	30-40	oui
Tourte aux pommes (8.5.2)		1	grille	170	90-120	oui
Tourte aux pommes (8.5.2)		1	grille	170	90-120	oui
Tourte aux pommes (8.5.2)		3	grille	180	90-120	oui
Surface gratinée (9.2.2)		5	grille	275	3-6	oui

* V závislosti na modelu

POZNÁMKA: Při vaření na 2 úrovních lze pokrm vyjmout v různých časech.



TABULKA KOMBINOVANÝCH AUTOMATICKÝCH FUNKCÍ S POUŽITÍM PÁRY

Poloha ovladače	Zobrazení v programové jednotce	Jídla	Množství přidané vody
		Kuře	500 ml vlažné vody do odkapávacího plechu
		Kachna	500 ml vlažné vody do odkapávacího plechu
		Krůta	500 ml vlažné vody do odkapávacího plechu
		Perlička	800 ml vlažné vody do odkapávacího plechu
		Celé ryby (velké)	500 ml vlažné vody do odkapávacího plechu
		Celé ryby (ploché)	300 ml vlažné vody do odkapávacího plechu
		Malé ryby celé	300 ml vlažné vody do odkapávacího plechu
		Rybí filety	300 ml vlažné vody do odkapávacího plechu
		Vepřová pečeně	500 ml vlažné vody do odkapávacího plechu
		Telecí pečeně	500 ml vlažné vody do odkapávacího plechu

DŮLEŽITÉ

Umístěte odkapávací plech (s vlažnou vodou) na spodní vodící lišty v úrovni 1 a pokrm, který budete péct, na vodící lišty v úrovni 3.

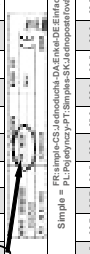

EN	Información for domestic ovens (UE n° 662014)	DE	Informationen zu Haushaltsbacköfen (UE n° 662014)
FR	Informations concernant les fours domestiques (UE n° 662014)	ES	Información sobre los hornos domésticos (UE n° 662014)
CS	Informace týkající se trou pro domácnosti (UE n° 662014)	IT	Informazione relative ai forni per uso domestico (UE n° 662014)
DA	Oplysninger for ovne til husholdningsbrug (UE n° 662014)	NL	Informatie met betrekking tot huishoudelijke ovens (UE n° 662014)
EL	Πληροφορίες για οικιακούς φούρνους (UE n° 662014)	FI	koteloitten uunien tiedot (UE n° 662014)

Symbol	Value	Unit	EN	FR	DE	ES	CS	DA	EL	SV	IT	NL	FI
KCD2SP													
KCD2ST													
KH72SP													
KH72ST													
KH75SP													
KH75ST													
KH78SP													
KH78ST													
KH79SP													
KH79ST													
KH73W													
KH74W													
KH75W													
KH76W													
KH77W													
Type norme													
Mode(s) identification													
Type of oven	Simple	FR: Impuls-ES: Automatische DA: Einzel-ES: Simple-IT: Semplice-NL: Simple-P: PoliposkyzP-T: Simple-SK: Jednotlivostřelné-EL: Απλό-FC: Yksitoiminen-SV: Enkel											
Mass of the appliance	M	34,6 30,7 35,7 33,6 36,2 36,6 36,0 33,6 36,6 38,0 38,0 38,0 43,1	kg										
Number of cavities		1 1 1 1 1 1 1 1 1 1 1 1 1											
Heat source per cavity (type of fuel or gas)			FR: Electricité-GS: Elektrizität-DA: Strøm-ES: Electricidad-IT: Energia elettrica-NL: Elektriciteit-Electricity-FC: Valmistusenergia-SK: Elektrická-EL: Ηλεκτρική										
Volume per cavity	V	73,0 73,0 73,0 73,0 73,0 73,0 73,0 73,0 73,0 73,0 73,0 73,0	l										
Energy consumption (mode per cavity) required to heat a standardised load in a heated oven during a cycle in conventional mode per cavity (electric final energy)	EC	0,82 0,82 0,69 0,70 0,70 0,70 0,70 0,70 0,70 0,70 0,70 0,70	kWh/cycle										
Energy consumption (mode per cavity) required to heat a standardised load in a heated oven during a cycle in fan-forced mode per cavity (electric final energy)	EC	1,23 1,34 1,23	kWh/cycle										
Energy efficiency index per cavity	EEl	90,3 86,3 80,2 81,4 81,4 81,4 81,4 81,4 81,4 81,4 81,4											

FR

CS

DA

DE

EL

EN

ES

FI

IT

NL

NO

PL

PT

SK

SV

Brandt



BRUGERVEJLEDNING DA

OVN

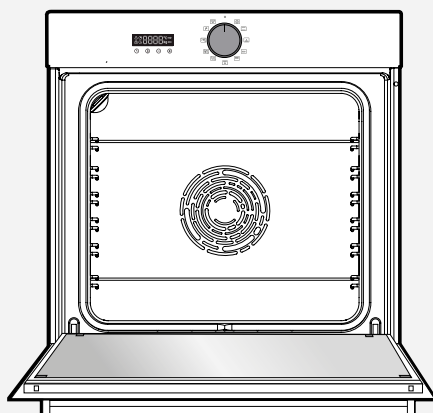

ORIGINE
FRANCE[®]
GARANTIE

BVCert.6011825

Kære kunde,

Du har lige anskaffet et BRANDT produkt, og vi takker for tilliden du viser os.

Vi har udviklet og fremstillet dette produkt med tanke på dig, din livsstil og dine behov, for at det på bedste måde skal imødekomme dine forventninger. Dette produkt har vi lagt vores knowhow, vores innovationsindsats og al den lidenskab, der har drevet os i mere end 60 år.

I vores utrættelige bestræbelser på altid at tilfredsstille vores kunders behov endnu bedre står vores kundeservice naturligvis til rådighed for at besvare alle dine spørgsmål og lytte til dine forslag.

Du kan også gå ind på vores website på www.brandt.com, hvor du finder alle vores seneste innovationer, samt nyttige supplerende oplysninger.

BRANDT er glad for at følge dig i din hverdag og vi håber, at du vil få det bedste udbytte af dit køb.

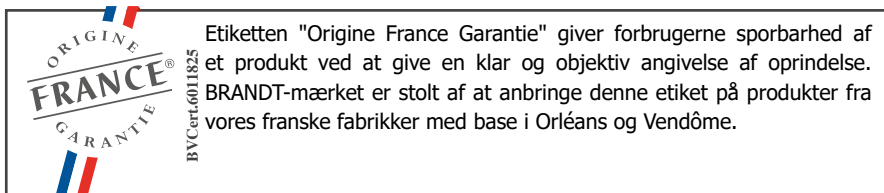

<https://brandt.fr/>

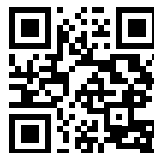

Vigtigt:

Inden opvaskemaskinen tages i brug, bør du læse denne installations- og brugsvejledning grundigt, så du hurtigt kan sætte dig ind i opvaskemaskinens funktioner



SIKKERHEDSINSTRUKTIONER	4
MILJØ OG ENERGIBESPARELSE	6
Miljø	6
Tip til energibesparelse.....	6
INSTALLATION AF DIT APPARAT	7
Valg af placering og installation	7
Elektrisk tilslutning	8
BESKRIVELSE AF DIT APPARAT	9
Præsentation af ovnen	9
Display- og kontroltaster	9
Tilbehør	10
BRUG AF DIN ENHED	12
Indstillinger	12
Indstillingsmenu	13
Tilberedningstilstande	14
Start af madlavning.....	15
VEDLIGEHOLDELSE AF DIN ENHED	17
Interiør - udvendig rengøring.....	18
Anomalier og løsninger	19
EFTERSALGSSERVICE	21
Interventioner	21
TILBEREDNINGSSSTØTTE	21
Madlavningskort	22
Opskrifter med gær	24
Funktionelle egnethedsprøver	25
Funktioner med automatisk kombineret damp	26



VIGTIGE SIKKERHEDSREGLER, SOM SKAL LÆSES NØJE OG GEMMES TIL FREMTIDIG BRUG.

Denne brugervejledning kan downloades fra mærkets internetsted.

Når du modtager apparatet, skal du straks pakke det ud eller straks få det pakket ud. Kontrollér den generelle fremtoning. Få eventuelle forbehold noteret på fragsedlen, og behold en kopi af den.

Vigtigt:

Dette apparat kan bruges af børn på 8 år og derover og af personer med nedsatte fysiske, sensorielle eller mentale evner eller som er blottet for erfaring eller kendskab, hvis de er under opsyn eller har fået forudgående instruktioner om en sikker anvendelse af apparatet og har forstået de risici, de udsætter sig for.

— Børn må ikke lege med apparatet. Rengøring og vedligeholdelse må ikke udføres af børn uden opsyn.

— Børn bør overvåges for at sikre, at de ikke leger med apparatet.

ADVARSEL:

— Selve ovnen og de tilgængelige dele bliver meget varme under brug. Pas på ikke at røre ved varmeelementerne inde i ovnen. Børn på under 8 år skal holdes på afstand, medmindre de er under konstant opsyn.

— Dette apparat er beregnet til madlavning med lukket ovndør.

— Før du foretager en pyrolyse rengøring af ovnen, skal du tage alle tilbehørsdele ud og fjerne de værste overstænkninger.

— I rengøringsfunktion kan ovnens overflader blive mere varme end under normal brug. Det anbefales at holde børn på afstand.

Det anbefales at holde børn på afstand.

— Der må ikke anvendes damprenseapparat.

— Der må aldrig anvendes slibemidler, slibesvampe eller metalsvampe til rengøring af ovnlåger af glas, da dette kan ridse overfladen og måske føre til, at ruden sprænger.

PAS PÅ :

Sørg for, at apparatet er frakoblet strømforsyningen, før lampen udskiftes for at undgå elektrisk stød. Vent, indtil apparatet er afkølet. Brug en gummihandske til at skrue lampeglasset af og tage pæren ud for at lette afmonteringen.

Efter installation skal stikkontakten være tilgængelig. Det skal være muligt at koble apparatet fra strømforsyningsnettet, enten ved hjælp af en stikforbindelse eller ved at indbygge en afbryder



Vigtige sikkerhedsregler

i de permanente rørledninger i overensstemmelse med installationsreglerne.

— Hvis forsyningskablet beskadiges, skal det udskiftes af fabrikanten eller dennes kundeservice eller en lignende kvalificerede person for at undgå enhver fare.

— Dette apparat kan installeres på et køkkenbord eller indbygges i et møbel som angivet på installationsskemaet.

— Sæt ovnen ind i et møbel, således at der er en minimal afstand på 10mm til møblet ved siden af. Det møbel, som ovnen bygges ind i, skal være lavet af et varmebestandigt materiale (eller være beklædt med et varmebestandigt materiale). For at opnå større stabilitet skal ovnen fastgøres i møblet med de 2 skruer gennem de huller, der er forudset til det.

— Apparatet må ikke installeres bag en låge, da det kan give overophedning.

— Dette apparat er udelukkende beregnet til anvendelser i private hjem og lignende steder såsom:

Køkkenhjørner forbeholdt personalet i butikker, på kontorer og i andre professionelle omgivelser. På gårde. Anvendelse af kunder på hoteller, moteller og andre beboelsemæssige omgivelser; omgivelser af typen bed & breakfast.

— Ovnen skal være standset, før

ovnkammeret gøres rent.

Der må ikke foretages ændringer i dette apparats egenskaber, det kan udgøre en fare for dig.

Brug aldrig ovnen som opbevaringssted for mad eller ting, når den ikke er i brug.



MILJØ

Emballagematerialet til denne enhed kan genbruges. Deltag i genbrug af dem og beskyt miljøet ved at placere dem i de kommunale containere, der er beregnet til dette formål.



Dit apparat indeholder også mange genanvendelige materialer. Det er derfor markeret med dette logo for at indikere, at brugte apparater ikke må blandes med andet affald.

Genbrug af apparater, der er organiseret af din producent, vil således blive udført under de bedste forhold i overensstemmelse med det gældende europæiske direktiv om affald af elektrisk og elektronisk udstyr. Kontakt dit rådhus eller din forhandler for indsamlingsstederne for brugte apparater tættest på dit hjem.

Vi takker dig for dit samarbejde om miljøbeskyttelse.

Energibesparende tip

Hold ovndøren lukket under tilberedningen.



VALG AF PLACERING OG INSTALLATION

Diagrammerne viser, hvilke mål et møbel skal have, for at ovnen kan sættes ind i det.

Dette apparat kan installeres enten under en plade (A) eller i kolonne (B). Hvis møblet er åbent, skal åbningen være på højst 70 mm bagpå C i D. Fastgør ovnen i møblet. For at gøre dette tages gummiholderne ud, og der forbores et hul med en diameter på 2 mm i møblets væg for at undgå, at træet sprækker. Fastgør ovnen ved hjælp af de to skruer. Sæt gummiholderne på plads igen.



Godt råd

For at være sikker på, at installationen er lovlig, bør du kontakte en el-installatør.



Advarsel:

Hvis den elektriske installation i dit hjem kræver ændringer for at tilslutte dit apparat, skal du ringe til en kvalificeret elektriker. Hvis ovnen viser uregelmæssigheder, skal du frakoble apparatet eller fjerne sikringen, der svarer til ovnens tilslutningsledning.

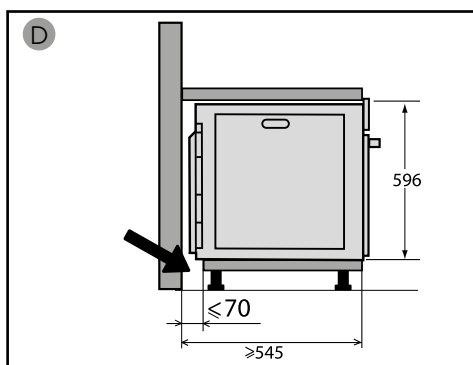
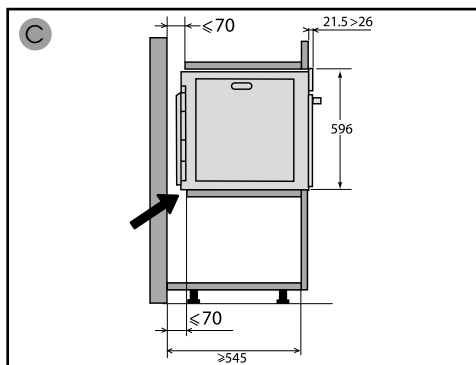
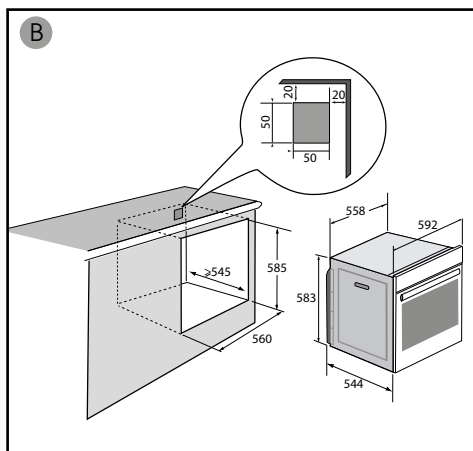
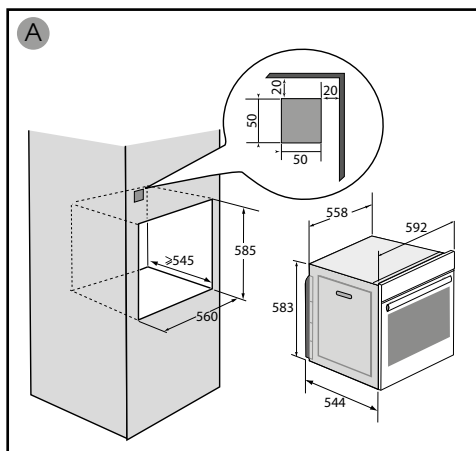



ELEKTRISK TILSLUTNING

Ovnen skal tilsluttes med et standard strømføringskabel med tre ledere på 1,5 mm² (1 fase + 1 neutral + jord), som skal være sluttet til elnet med 220~240 volt ved brug af et standard strømstik CEI 60083 eller en omnipolær afbryderanordning iht. gældende bestemmelser for installation.

Attention

Beskyttelsesledningen (grøn-gul) forbindes til apparatets klemskrue  og installationen skal have jordforbindelse. Installationens sikring skal være på 16 A.

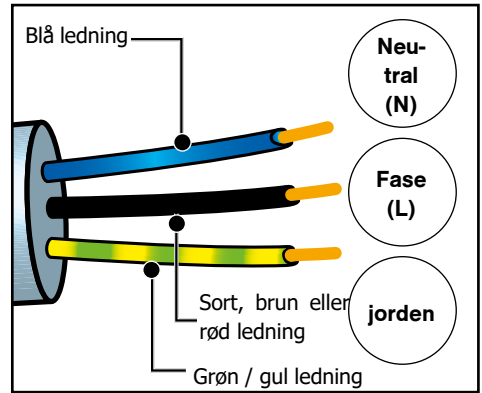

Vi kan ikke drages til ansvar for ulykker eller uheld på grund af en manglende, beskadiget eller ukorrekt jordforbindelse eller i tilfælde af ikke korrekt tilslutning.

• Før første brug

Inden du bruger ovnen første gang, skal du opvarme den tom, med døren lukket, i ca. 15 minutter på den højeste temperatur. for at bryde ind i enheden. Mineraluld, der omgiver ovnrummet, kan oprindeligt afgive en særlig lugt på grund af dets sammensætning. På samme måde kan du bemærke røg. Alt dette er normalt.



Præsentation af ovnen

PRÆSENTATION AF OVNE

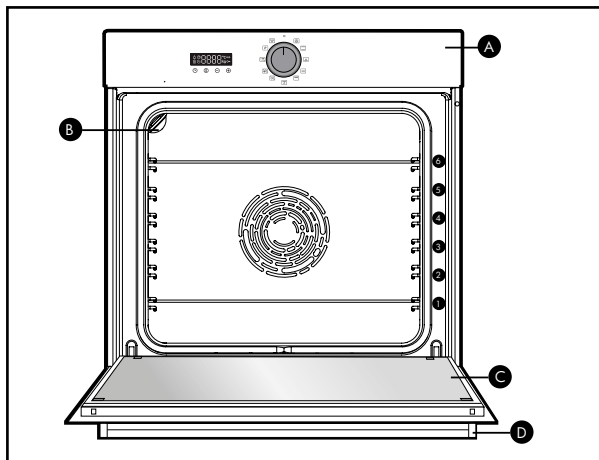

- A** Betjeningspanel
- B** Lampe
- C** Låge
- D** Håndgreb

Denne ovn har 6 ribbepositioner til tilbehørsdele: ribbe 1 til 6.

• Visning på display



- Tilberedningstid
- Slutning på tilberedning
- Spærring af tastatur
- Minutur
- Temperaturindikator
- Indikator for forvarmning
- Låsning af låge

• Taster

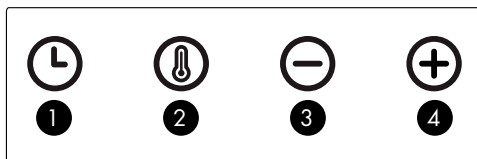

- 1** Indstilling af klokken og varighed
- 2** Indstilling af temperatur
- 3** - tasten
- 4** + tasten



TILBEHØR

• Sikker rist, der ikke kan vippe

Risten kan anvendes til at stille fad og forme ind i ovnen med retter, som skal steges eller gratineres. Den kan også anvendes til at grillstege kød (lægges direkte på risten).

Risten, der er sikret mod vipning, skubbes ind i ovnen.

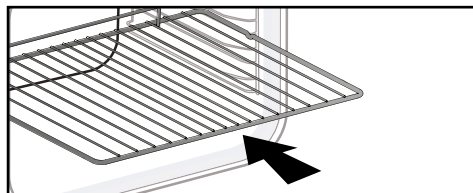

• Universal bradepande 45 mm

Indsættes i ribberne under risten med håndgrebet mod ovnlågen. Den kan opsamle saft og kraft fra det grillstegte kød. Den kan også fyldes halvt med vand til tilberedning i vandbad.

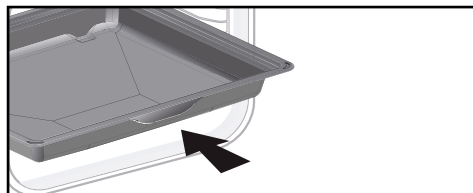

• Bageplade 20 mm

Indsættes i ribberne med håndgrebet mod ovnlågen. Meget god til bagning af cookies, småkager, tørkager, små kager i form. Dens hældende form gør det let at flytte dine tilberedninger til et fad. Kan også indsættes i ribberne under risten for at opsamle kraft, saft og fedt fra grillstegt kød.

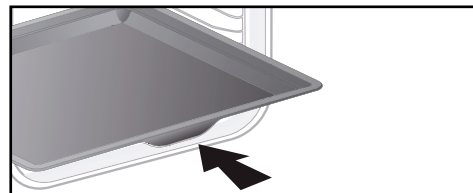

• System med glideskinner

Takket være systemet med glideskinner, bliver håndteringen af fødevarer nu praktisk og let, da pladerne kan tages forsigtigt ud. Det forenkler arbejdet optimalt. Pladerne kan trækkes helt ud, så man har adgang til hele fladen.

Desuden tillader pladernes stabilitet, at du kan arbejde med og håndtere fødevarerne korrekt. Dette system gør det meget lettere at tage fødevarerne ud af ovnen.

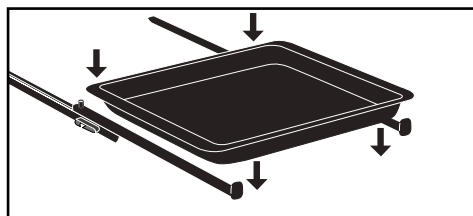

Advarsel :

Fjern tilbehøret og hylderne fra ovnen inden pyrolyserensning påbegyndes.

Advarsel :

Under påvirkning af varme kan tilbehør deformeres uden at påvirke deres funktion. De vender tilbage til deres oprindelige form, når de afkøles.



MONTERING OG AFMONTERING AF GLIDESKINNER

Efter at de 2 ribber er udtaget, vælges ribbehøjden (fra 2 til 5), hvor du ønsker at fastgøre skinnerne. Skub skinnen ind over venstre ribbe ved at øge et tilstrækkeligt pres i forenden og bagenden af skinne, til at de 2 greb på skinnens side går ind over ribben. Gå frem på samme måde med den højre skinne.

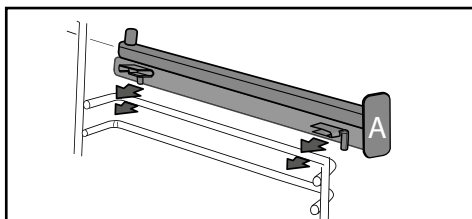

BEMÆRKNING: Den teleskopiske del af skinnen skal udfoldes ud ad ovnen, og endestoppet **A** skal være foran dig.

Sæt de 2 ribber på plads, og sæt derefter pladen på de 2 ribber, systemet er klar til brug.

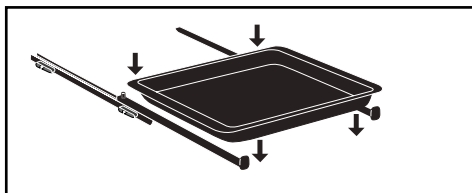

For afmontering af skinnerne skal ribberne tages ud af ovnen igen.

Adskil dem let nedad med grebene fastgjort på hver skinne for at frigøre dem fra ribben. Træk skinnen mod dig selv.

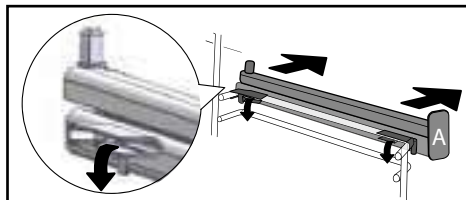

Rådgivning:

For at undgå udslip af dampe, når du tilbereder fedtet kød, anbefaler vi, at du tilsætter en lille mængde vand eller olie i bunden af gryden.



RÉGLAGES

• Indstilling af klokken

Når ovnen tændes , blinker displayet på 12:00.

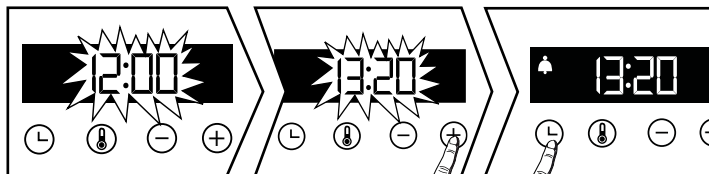

Når ovnen tændes , blinker displayet på 12:00.

Klokken indstilles med tasten+ eller -.Godkend med tasten . Ved strømafbrydelse blinker visningen af klokken.

• Ændring af klokken

Funktionsvælgeren skal stå på position 0.

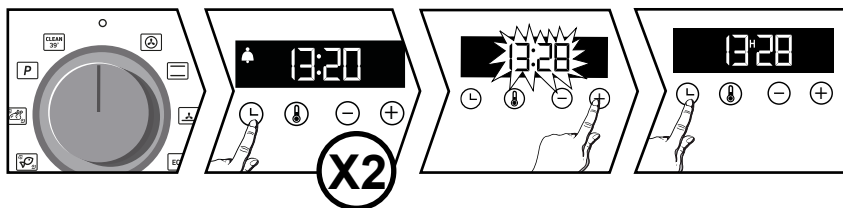

Tryk på tasten symbolet symbolet vises tryk igen på .Justér urets indstilling med tasten + eller - .Godkend med tasten . Registrering af den justerede tid sker automatisk efter nogle sekunder.

• Minutur

Denne funktion kan kun anvendes, når ovnen er slukket.

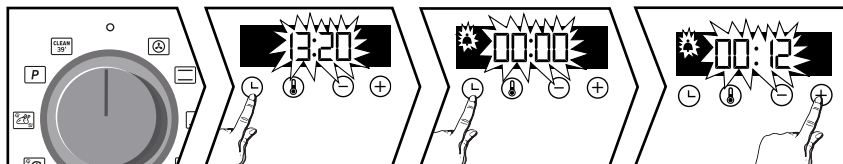

Funktionsvælgeren skal stå på position 0.

Tryk på tasten symbolet blinker. Indstil minuturet med tasten+ eller - . Godkend med tasten .

NB: Du kan når som helst ændre eller annullere indstillingen af minuturet. For at annullere skal du vende tilbage til menuen for minutur og indstille det på 00:00. Uden godkendelse vil registreringen automatisk bliver udført efter få sekunder



Brug af din enhed

• SPÆRRING AF TASTATUR

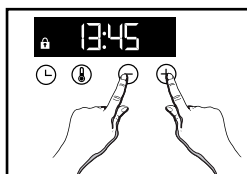



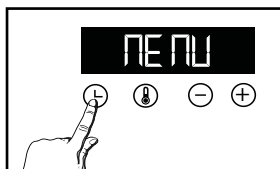

Tryk samtidigt på tasterne + og -, indtil symbolet  vises på skærmen. For at oplåse trykkes samtidigt på tasten + og -, indtil symbolet  forsvinder fra skærmen.

MENU

Du kan lave flere forskellige indstillinger på ovnen. For at gøre dette: Tryk på tasten  , indtil "MENU" vises, for at komme til tilstand for indstilling.



Tryk igen på tasten  for at gennemse de forskellige indstillinger. Aktiver eller deaktiver med tasterne + et - de forskellige parametre, se tabellen i det følgende:

	AUTO: Når i tilstand for tilberedning slukker lyset i oven efter 90 sekunder ON: Når i tilstand for tilberedning er lampen tændt hele tiden.
	Aktiver/deaktiver tasternes bip
	Aktiver/deaktiver booster-tilstand
	Aktiver/deaktiver demo-tilstand

For at gå ud af "MENU" trykkes igen på .



Brug af din enhed

TILBEREDNINGSFUNKTIONER

Fonctions manuelles :



ROTARENDE VARMLUFT*

Min.temperatur 35°C, maks.temperatur 250°C
Anbefales til hvidt kød, fisk og grønsager for at bevare en rund og fyldig smag. Til flere tilberedninger samtidigt på op til 3 niveauer.



TRADITIONEL OVN

Min.temperatur 35°C, maks.temperatur 275°C
Anbefales til en langsom og udsøgt tilberedning: Vildt steg m.m. Til at brune en oksesteg. Til langtidstegning i stegeso eller cocotte af gryderetter, som er startet på komfur (coq au vin, ragout).



KUN VARMLUFT

Min. temperatur 75°C, maks. temperatur 250°C
Anbefales til fugtige retter (quiche, saftige frugttærter m.m.). • Dejen bliver mere sprød på undersiden. Anbefales til tilberedninger der hæver (kage, brioche, kouglof m.m) og til souffléer, som ikke bliver forhindret i at hæve af en skorpe oven på.



ØKO*

Min. temperatur 35°C, maks. temperatur 275°C
Denne position muliggør en energibesparelse og bevare samtidigt bagningens kvalitet. Al tilberedning sker uden forvarmning.



KRAFTIG GRILL

Min. temperatur 180°C, maks. temperatur 275°C
Anbefales til at grille toasts, gratinere en ret, brune en crème brûlée m.m.



VARMLUFTS GRILL

Min.temperatur 100°C, maks.temperatur 250°C
Fjerkræ og stege bliver saftige og sprøde på alle sider. Stil bradepanden ind på nederste ribbe. Anbefales til fjerkræ eller steg, til at brune og gennemstege lammekølle, oksekoteletter. Til at bevare fiskebøffer bløde indeni.

Automatiske funktioner :

Brandt tilbyder dig 3 ny funktioner, der automatisk kombinerer to stegemåder: traditionel stegning og damptilberedning, der bevare madvarenes ernæringsværdier og giver en hurtigere tilberedning.



HVIDT KØD

Anbefalet til bevaring af svine- og kalvesteges mørhed



FISK

Anbefales til stegning af hele fisk og fileter.



FJERKRÆ

Anbefales til stegning af kyllinger, kalkuner, perlehøns og ænder.

Ved disse tre funktioner skal der blot tilføjes lunken vand i tilstrækkelig mængde i din bradepande, der sættes i ovnen på den nederste ribbe, mens den madvare, der skal steges, sættes på niveau 3.

Angående den vandmængde, der skal tilføjes i bradepanden, henvises til skemaet over kombinerede automatfunktioner med damp sidst i vejledningen.

** Tilberedningsmetode udført i henhold til kravene i standard EN 60350-1: 2016 for at påvise overholdelse af energimærkningskravene i europæisk regulering EU / 65/2014.*



Brug af din enhed

START AF MADLAVNING

• Starter øjeblikkelig madlavning

Programmøren skal kun vise klokkeslættet. Dette skal ikke blinke.

Drej funktionsvælgeren til den ønskede position.

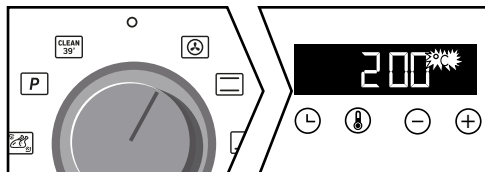



Vedrørende de manuelle funktioner:

Temperaturen begynder straks at stige. Ovn anbefaler en temperatur, der kan ændres. Ovn varmer, og indikatoren for temperatur blinker. Ovn sender en række bip, når den har nået den programmerede temperatur.

Vedrørende automatiske funktioner:

 vises på displayet.

Vælg din madvare ved hjælp af skemaet sidst i vejledningen. Tryk på tasterne + og - indtil du ser det ønskede skema på displayet og godkend herefter med tasten .

En vægt blinker, indtast din madvares faktiske vægt med tasterne + og - godkend .

Der er intet andet at indstille: stegetemperaturen og -tiden udregnes automatisk. Klokkeslættet for endt stegning blinker, godkend med tasten . Din stegning begynder straks herefter.



• Ændring af temperaturen

Tryk på .

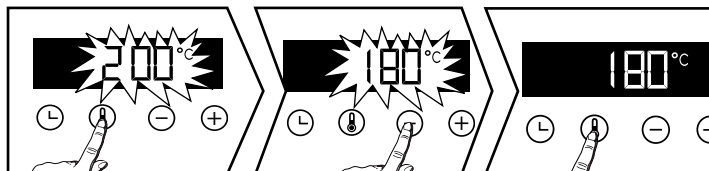
Juster temperaturen med + eller -. Godkend ved at trykke på .



• Programmering af varighed

Udfør en øjeblikkelig tilberedning, og tryk derefter på , tilberedningstiden  blinker, og indstillingen er nu mulig. Tryk på + eller - for at indstille tilberedningstiden.

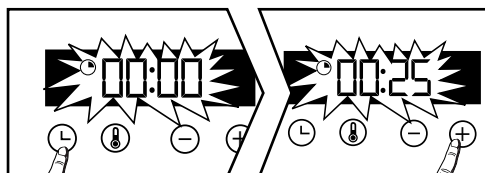





Ovnen er udstyret med funktionen "SMART ASSIST", som ved en programmering af varighed vil foreslå en tilberedningstid, der kan ændres, i forhold til den valgte tilberedningsmåde.

Se tabellen herunder:

Indlæsningen af tilberedningens varighed sker automatisk efter nogle sekunder. Nedtælling af varigheden starter straks, når tilberedningstemperaturen er opnået.

TILBEREDNINGSFUNKTIONER	ANBEFALINGER AF VARIGHED
	30 min
	30 min
	30 min
ECO	30 min
	7 min
	15 min

• Tilberedning med udskudt start

Følg samme fremgangsmåde som for programmeret varighed. Efter indstilling af tilberedningstiden trykkes på tasten , klokkeslæt for afslutning af tilberedning  blinker.

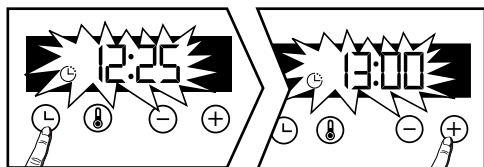

Visningen blinker, indstil klokken for afslutning af tilberedning med + eller -.

Indlæsningen af slutning på bagning sker automatisk efter nogle sekunder. Visningen af slutning på tilberedning blinker ikke mere.



• Rengøring af hulrummet ved pyrolyse



Vigtigt

Tag tilbehøret og ribberne ud af ovnen før start af rensning med pyrolyse. Før du går i gang med en ovenrensning med pyrolyse, skal du fjerne evt. madrester og overkog. Fjern også fedt på lågen ved brug af en fugtig svamp.

Af sikkerhedsårsager sker pyrolysen efter automatisk blokering af ovenlågen. Det er umuligt at låse lågen op under pyrolysen.

• Selvrensning straks

Programvælgeren skal vise dagens klokkeslæt, uden at blinke. Vælg en cyklus med selvrensning ved hjælp af funktionsvælger  eller  :

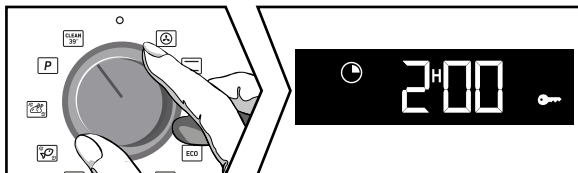

 = **rensning på 39 minutter**

- Efter hver stegningen ruller «Clean 39» over skærmen, og du foreslås at starte rensningen. Indstil funktionsvælgeren på denne funktion og godkend med tasten . Varigheden 0:39 defilerer skiftevis med «Clean 39», og din rensning starter. Efter nogle minutter ses en nøgle, og ovenlågen låses af sikkerhedsårsager automatisk under hele programmet.

Hvis du ønsker at starte en «Clean 39» ved kold eller utilstrækkeligt varm ovn, er betingelserne for start af denne rensfunktion ikke opfyldt. 0:00 vises på displayet, og du kan herefter vælge en anden selvrensningsposition  .

 = **Pyrolyse på 2 timer**. Indstil funktionsvælgeren på denne funktion.



Indstil funktionsvælgeren på denne funktion.  vises på displayet. Tryk på + for at vælge din pyrolyse, afhængigt af hvor snavset din ovn er.

Den valgte varighed, 2:00 vises på displayet. Godkend med tasten .  vises, og pyrolysen starter.

Ved slutningen af rensningen, viser displayet 00:00, og ovenlågen låses op.

Stil funktionsvælgeren tilbage på 0.

• Udskudt selvrensning

Du kan vælge at udskyde starten på din pyrolyse. Når programmets varighed vises på displayet, trykkes der på knappen , og det ny slutklokkeslæt indstilles med knapperne + og -, hvorefter det godkendes med . Selvrensningen vil gå i gang senere og slutter på det programmerede klokkeslæt. Stil programvælgeren tilbage på 0, når rensningen er slut.



Rengøring

• Rengøring af den udvendige overflade

Brug en blød klud gennemblødt i vinduesrensers. Brug ikke skurecremer eller en skrubesvamp.

• Rengøring af trådstativene

Skil trinledningerne ad for at rengøre dem. Løft den forreste del af trinnet op; skub hele trin op, og slip den forreste krog fra huset. Træk derefter let skridtet mod dig for at løsne de bageste kroge fra deres hus. Fjern de to trin.

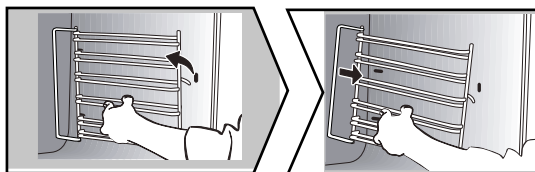

• Rengøring af dørglas

Advarsel:

Brug ikke skurepulver, slibende svamp eller metalskrabere til at rengøre ovnsens glasdør, som kan ridse overfladen og få glasset til at knuses.

Fjern først det overskydende fedt fra den indvendige rude med en blød klud og opvaskemiddel. For at rengøre de forskellige indvendige ruder skal du adskille dem på følgende måde:

• Rengøring af dørglas

Åbn døren helt, og bloker den ved hjælp af den plastkile, der findes i enhedens plastpose.

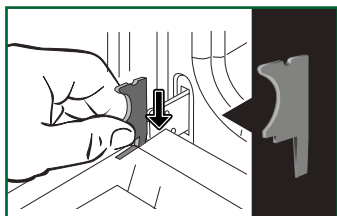

Fjern den første afskårne rude: tryk med et værktøj (skruetrækker) i placeringen (A) for at fjerne ruden, og fjern den derefter.

Vigtig:

Sørg for at markere retningen for samling af dette 1. vindue (skinnende side mod dig)



Afhængigt af modellen består døren af to ekstra ruder med en sort gummi afstand i hvert hjørne. Fjern dem om nødvendigt for rengøring.

Nedsenk ikke vinduerne i vand. Skyl med rent vand og tør det af med en frugtfri klud.

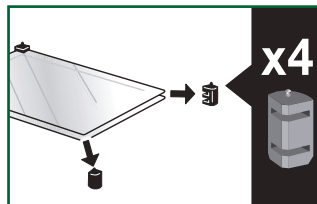
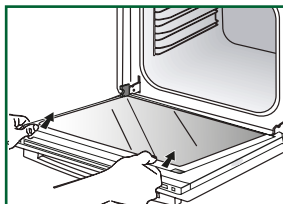
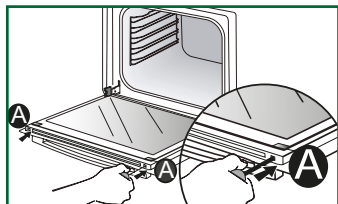

• Montering af dørvinduerne

Efter rengøring skal du flytte de fire opadgående gummistop og placere glassamlingen igen.

Sæt den sidste rude i metalstoppene, og klip den derefter med den blanke side mod dig. Fjern plastkilen. Din enhed er i drift igen.

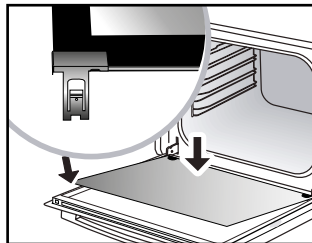
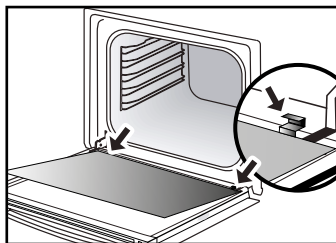
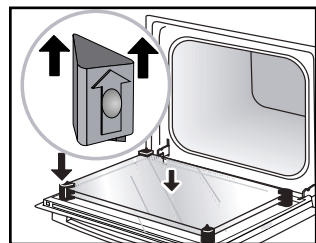

• Udskiftning af pæren



Advarsel:

Sørg for, at apparatet er slukket og ledningen taget ud før udskiftning af ovnlampe for at undgå elektrisk stød. Vent, indtil apparatet er nedkølet.

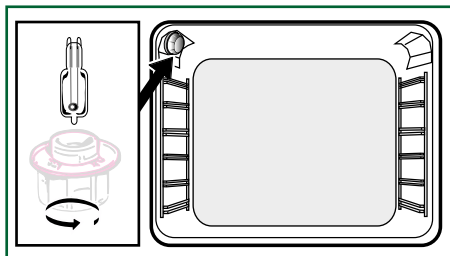

Pærens egenskaber:

15 W, 220-240 V~, 300°C, sokkel G9.

Du kan endda udskifte lampen, når den holder op med at virke. Bestem vinduet, fjern derefter lampen (brug en elastik til at lette demonteringen). Indsæt den nye pære, og udskift vinduet.



FEJL OG AFHJÆLPNINGER

Ovnen varmer ikke op.

Kontrollér, om ovnen får tilført strøm, eller om der er sprunget en sikring i din eltavle. Øg den valgte temperatur.

Lampen i ovnen fungerer ikke.

Udskift pæren eller sikringen. Kontrollér, om ovnen er tilsluttet elnettet.

Køleventilatoren fortsætter med at køre efter slukning af ovnen.

Det er helt normalt, at ventilationen kan køre helt op til maks. 1 time efter tilberedning i ovnen. Det sker for at sænke temperaturen inde i ovnen. Hvis det fortsætter ud over en time kontaktes kundeservice.

Man kan ikke rense ovnen ved brug af pyrolyse.

Kontrollér, at ovnlågen er lukket korrekt. Hvis det drejer sig om en fejl ved lukning af lågen eller ved temperaturføleren, kontaktes kundeservice.

Symbolet blinker på displayet.

Fejl ved låsning af lågen, kontakt kundeservice.

Vibreende støj.

Kontroller, at netledningen ikke er i kontakt med bagvæggen.

Dette påvirker ikke enhedens korrekte funktion, men kan alligevel generere en vibrerende støj under ventilation. Fjern enheden, og flyt ledningen. Udskift din ovn.



INDGREB

Eventuelle indgreb på apparatet skal foretages af en kvalificeret tekniker, som er autoriseret af mærket. Når du ringer til os, skal du, for at vi bedre kan hjælpe dig, have alle oplysningerne om dit apparat klar (salgsartikel nr., servicereference, serienummer). Disse oplysninger står på typeskiltet.

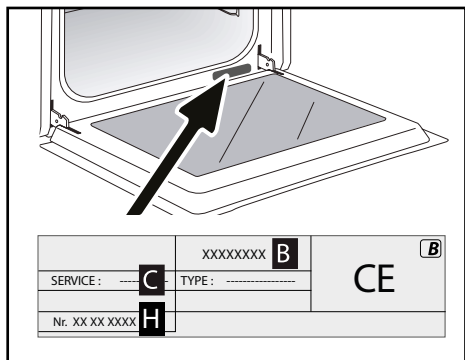

- B: Forhandlingsreference
- C: Servicereference
- H: Serienummer

ORIGINALDELE:

I forbindelse med reparationer skal du anmode om, at der kun anvendes originaldele.





RETTER	* * * * * * *												
Kød													
Svinesteg (1 kg)	200	2					180	2				60	
Kalvesteg (1 kg)	200	2					180	2				60-70	
Oksesteg	240	2										30-40	
Lam (kølle, bov 2,5 kg)	220	1			220					200	2	60	
Fjerkræ (1 kg)	200	2			220		180	2		210	3	60	
Fjerkræ, store dele	180	1										60-90	
Kyllingelår					220	3				210	3	20-30	
Svine/kalvekoteletter					210	3						20-30	
Oksekoteletter (1 kg)					210	3				210	3	20-30	
Fårekoteletter					210	3						20-30	
Fisk													
Grillet fisk					275	4						15-20	
Kogt fisk (havrude/brasen)	200	3					180	3				30-35	
Indpakket fisk	220	3					200	3				15-20	
Grøntsager													
Gratiner (tilberedte madvarer)					275	2						30	
Kartoffelgratin	200	2					180	2				45	
Lasagner	200	3					180	3				45	
Farserede tomater	170	3					160	2				30	
Kager													
			180	2							180	2	35
Rullede småkager	220	3									180	2	5-10
Brioche	180	1	210								180	2	35-45
Brownies	180	2					175	3					20-25
Cake - Pund-til-pund	180	1	180	1							180	2	45-50
Clafoutis	200	2					180	3					30-35
Cremer	165	2									150	2	30-40

* afhængig af model



RETTER	*	*	*	*	*	*	*	*	

Kager

Madeleinekager	220	3					200	3								5-10
Vandbakkelser	200	3					180	3					180	3		30-40
Petit fours af butterdej	220	3					200	3								5-10
Savarinkage	180	3											175	3		30-35
Mørdej	200	1					195	1								30-40
Butterdej til tærte	215	1					200	1								20-25
Gærdej til tærte	210	1					200	1								10-30

Diverse

Spyd	220	3			210	4										10-15
Postej	200	2					190	2								80-100
Pizzamørdej	200	2														30-40
Pizzagærdej																15-18
Quiche																35-40
Soufflé													180	2		50
Pie	200	2														40-45
Brød	220						200		220							30-40
Ristet brød	180				275	4-5										2-3
Lukket trykkoger (stuvning)	180	2											180	2		90-180

* afhængig af model

**Ovnens foropvarmes til temperaturen anført.**

Før kødet stilles i ovnen skal det have stået i mindst en time ved stuetemperatur.

ÆKVIVALENS: TAL T °C

°C	30	60	90	120	150	180	210	240	275
Tal	1	2	3	4	5	6	7	8	9 maxi

Opskrift med gær (ifølge modellen)

Ingredienser:

- Mel 2 kg
- Vand 1240 ml
- Salt 40 g
- 4 pakker tørret gær

Rør dejen med mikser og dejkroge, og lad dejen hæve i ovnen.

Fremgangsmåde: For dejopskrifter med gær. Hæld dejen i et ildfast fad, tag holderne ud af ribberne, og sæt fadet i bunden.

Varm ovnen op med varmluftfunktionen til 40-50 °C i 5 minutter. Stands ovnen, og lad dejen hæve i 25-30 minutter i kraft af den overskydende varme.

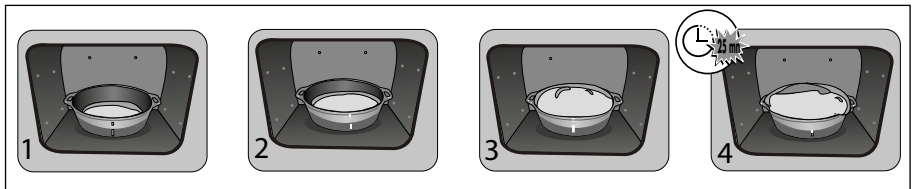



TEST AF FUNKTIONENS EGNETHED IHT. STANDARDEN IEC 60350

FØDEVARE	Tilberedningsfunktioner *	TRIN	TILBEHØR	°C	TID min.	FORVARMNING
Småkager (8.4.1)		5	dyb plade	150	30-40	Ja
Småkager (8.4.1)		5	dyb plade	150	25-35	Ja
Småkager (8.4.1)		2 + 5	dyb plade + rist	150	25-45	Ja
Småkager (8.4.1)		3	dyb plade	175	25-35	Ja
Småkager (8.4.1)		2 + 5	dyb plade+ rist	160	30-40	Ja
Små cakes (8.4.2)		5	dyb plade	170	25-35	Ja
Små cakes (8.4.2)		5	dyb plade	170	25-35	Ja
Små cakes (8.4.2)		2 + 5	dyb plade + rist	170	20-40	Ja
Små cakes (8.4.2)		3	dyb plade	170	25-35	Ja
Små cakes (8.4.2)		2 + 5	dyb plade + rist	170	25-35	Ja
Saftig kage uden fedtstof (8.5.1)		4	rist	150	30-40	Ja
Saftig kage uden fedtstof (8.5.1)		4	rist	150	30-40	Ja
Saftig kage uden fedtstof (8.5.1)		2 + 5	dyb plade + rist	150	30-40	Ja
Saftig kage uden fedtstof (8.5.1)		3	rist	150	30-40	Ja
Saftig kage uden fedtstof (8.5.1)		2 + 5	dyb plade + rist	150	30-40	Ja
Æbletærte (8.5.2)		1	rist	170	90-120	Ja
Æbletærte (8.5.2)		1	rist	170	90-120	Ja
Æbletærte (8.5.2)		3	rist	180	90-120	Ja
Gratineret overflade (9.2.2)		5	rist	275	3-6	Ja

* afhængig af model

BEMÆRKNING: For tilberedning i 2 niveauer kan retterne tages ud efter forskellig tilberedningstid



SKEMA OVER KOMBINEREDE FUNKTIONER AUTOMATISKE ASSOCIERET MED DAMP

Knappens position	Visning på programvælger	Madvarer	Kvantitet væske der skal tilføjes
		Kylling	500 ml lunkent vand i bradepanden
		And	500 ml lunkent vand i bradepanden
		Kalkun	500 ml lunkent vand i bradepanden
		Perlehøne	800 ml lunkent vand i bradepanden
		Hele fisk (store)	500 ml lunkent vand i bradepanden
		Hele fisk (flade)	300 ml lunkent vand i bradepanden
		Små hele fisk	300 ml lunkent vand i bradepanden
		Fiskefilet	300 ml lunkent vand i brandpanden
		Svinesteg	500 ml lunkent vand i bradepanden
		Kalvesteg	500 ml lunkent vand i bradepanden

VIGTIGT

Positioner bradepanden (med det lunkne vand) på den nederste ribbe, niveau 1 og din madvare, der skal steges, på ribbe niveau 3.



EN Informații pentru domeniul de aplicare (UE n° 6620/14)
DE Informationen zu Anwendungsbereich (UE n° 6620/14)
FR Informations concernant les fins d'application (UE n° 6620/14)
ES Información sobre los fines de aplicación (UE n° 6620/14)
CS Informační údaje ke záměru aplikace (UE n° 6620/14)
IT Informazioni relative al fine per cui sono destinati (UE n° 6620/14)
DA Oplysninger for oven til huseftersøgning (UE n° 6620/14)
NL Informatie met betrekking tot huseftersogingen (UE n° 6620/14)
SV Tillämpningsområde (UE n° 6620/14)

EN	DE	FR	ES	CS	IT	DA	NL	SV										
EN	Information for domestic ovens (UE n° 6620/14)	Informationen zu Haushaltsbacköfen (UE n° 6620/14)	Informations concernant les fours domestiques (UE n° 6620/14)	Información sobre los hornos domésticos (UE n° 6620/14)	Informační údaje ke záměru aplikace (UE n° 6620/14)	Informazioni relative al fine per cui sono destinati (UE n° 6620/14)	Informație met betrekking tot huseftersogingen (UE n° 6620/14)	Tillämpningsområde (UE n° 6620/14)										
Symbol	KCD2SP	KCD2ST	KX72SP	KX72SP	KX72SP	KX72SP	KX72SP	KX72SP										
Type norme			KX72SP	KX72SP	KX72SP	KX72SP	KX72SP	KX72SP										
Modele identificati			KX72SP	KX72SP	KX72SP	KX72SP	KX72SP	KX72SP										
Type of oven			FR: Impulsiv- und intermittierend-Druckbackofen PL: Płytkowy i impulsowy piekarnik ciśnieniowy IT: Impulsivo e intermittente forno a pressione ES: Forno de impulsión y funcionamiento intermitente CS: Impulzivní a intermitentní tlakový troubač DA: Impulsiv og intermitterende trykbagt ovn NL: Impulsief en intermitterend drukoven SV: Impulsiv och intermitterande trykugns															
Mass of the appliance	M	34,6	30,7	35,7	33,6	36,2	36,6	36,0	36,0	36,0	34,1	33,1	33,1	33,1	33,1	33,1	33,1	33,1
Number of cavities		1	1	1	1	1	1	1	1	1	1	1	1	1	1	1	1	1
Heat source per cavity (type of fuel or gas)			FR: Electricité-ES: Electricidad-DE: Strom-E: Energia elettrica-NE: Električna energija-PL: Energia elektryczna-IT: Energia elettrica-ES: Electricidad-DA: Elektricitet-EL: Ηλεκτρική ενέργεια-EN: Electricity															
Volume per cavity	V	730	730	730	730	730	730	730	730	730	730	730	730	730	730	730	730	730
Energy consumption (mode per cavity) required to heat a standardised load in a heated oven during a cycle in fan-forced mode per cavity (electric final energy)	EC	0,82	0,82	0,89	0,79	0,79	0,79	0,79	0,79	0,79	0,79	0,79	0,79	0,79	0,79	0,79	0,79	0,79
Energy efficiency index per cavity	EEl	90,3	86,3	80,2	81,4	81,4	81,4	81,4	81,4	81,4	81,4	81,4	81,4	81,4	81,4	81,4	81,4	81,4

FR

CS

DA

DE

EL

EN

ES

FI

IT

NL

NO

PL

PT

SK

SV

Brandt



BENUTZERANLEITUNG DE

BACKOFEN

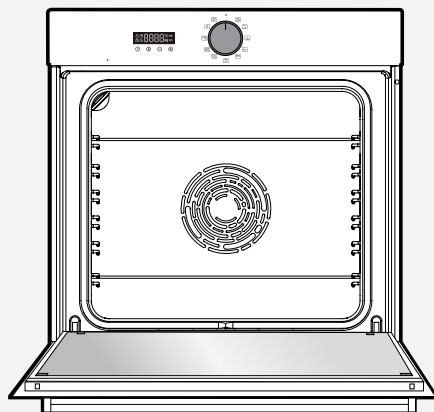

ORIGINE
FRANCE[®]
GARANTIE

BYCert.6011825

Liebe Kundin, lieber Kunde,

Sie haben soeben ein **BRANDT** Produkt erworben, und wir danken Ihnen für Ihr Vertrauen. Wir haben bei der Planung und Herstellung dieses Produktes an Sie gedacht, an Ihren Lebensstil, an Ihre Bedürfnisse, damit es ihren Erwartungen bestmöglich entspricht. In diesem Produkt steckt unser Know-how, unser Innovationsgeist und die ganze Leidenschaft, die uns seit mehr als 60 Jahren antreibt.

Wir sind stets darum bemüht, Ihre Anforderungen immer besser zu erfüllen. Unser Verbraucherservice steht Ihnen daher selbstverständlich immer zur Verfügung und geht auf alle Ihre Fragen und Anregungen ein.

Besuchen Sie auch unsere Website **www.brandt.com** Sie finden dort eine Übersicht über unsere neuesten Innovationen, sowie weitere nützliche Hinweise.

BRANDT ist geehrt, Sie im Alltag zu begleiten, und wünscht Ihnen viel Freude mit Ihrem neuen Produkt.

 <p>ORIGINE FRANCE® GARANTIE</p>	<p>Das Label "Origine France Garantie" bietet Verbrauchern die Rückverfolgbarkeit eines Produkts durch eine klare und objektive Angabe der Herkunft. Die Marke BRANDT ist stolz darauf, dieses Etikett auf Produkten unserer französischen Fabriken in Orléans und Vendôme anzubringen.</p> <p>BVCert.0011825</p>
---	---

<https://brandt.fr/>

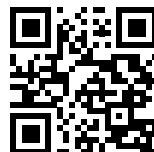

Wichtig: Bitte lesen Sie die vorliegenden Hinweise zu Installation und Gebrauch vor der ersten Inbetriebnahme aufmerksam durch, damit Sie Ihr Gerät schnell beherrschen.



SICHERHEITSHINWEISE	4
UMWELT UND ENERGIESPAREN	6
Umwelt.....	6
Energiespar-Tipp	6
INSTALLATION IHRES GERÄTS	7
Standortwahl und Installation	7
Elektrischer Anschluss	8
BESCHREIBUNG IHRES GERÄTS	9
Präsentation des Ofens	9
Anzeige- und Steuertasten	9
Zubehör	10
VERWENDEN IHRES GERÄTS	12
Einstellungen	12
Einstellungsmenü	13
Kochmodi	14
Starten eines Kochvorgangs	15
PFLEGE IHRES GERÄTS	17
Innen- - Außenreinigung	18
Anomalien und Lösungen	19
KUNDENDIENST	21
Interventionen	21
KOCHHILFE	21
Kochkarten	22
Rezepte mit Hefe	24
Funktionsfähigkeitstests	25
Funktionen mit automatischem kombinierten Dampf	26



WICHTIGE SICHERHEITSHINWEISE - AUFMERKSAM LESEN UND FÜR SPÄTERE NUTZUNG AUFBEWAHREN.

Sie können diese Gebrauchsanweisung auf der Internetseite der Marke herunterladen.

- Das Gerät bei Lieferung sofort auspacken oder auspacken lassen. Sein allgemeines Aussehen prüfen. Vermerken Sie eventuelle Vorbehalte schriftlich auf dem Lieferschein und behalten Sie ein Exemplar davon.
-
- Wichtig:
 - Dieses Gerät kann von Kindern ab einem Alter von 8 Jahren, von Personen mit körperlich, sensorisch oder geistig eingeschränkten Fähigkeiten oder von Personen ohne Erfahrung oder Kenntnis verwendet werden, wenn sie beaufsichtigt oder in die Gerätebenutzung eingewiesen worden sind, auch was die Sicherheit betrifft, und wenn sie die damit verbundenen Risiken verstanden haben.
 - — Kinder dürfen nicht mit dem Gerät spielen. Beim Reinigen und Pflegen dürfen Kinder nicht unbeaufsichtigt bleiben.
 - — Kinder müssen beaufsichtigt werden, damit sie nicht mit dem Gerät spielen.
- **WARNUNG:**
 - — Das Gerät und seine zugänglichen Teile werden bei der Benutzung heiß. Die Heizelemente im Backofen nicht berühren. Kinder in einem Alter von weniger als 8 Jahren müssen vom Gerät ferngehalten werden, sofern sie nicht ständig überwacht werden.
 - — Dieses Gerät ist für das Garen bei geschlossener Tür bestimmt.
 - — Vor der Reinigung des Backofens durch Pyrolyse nehmen Sie bitte alles Zubehör heraus und entfernen Sie größere Spritzer.
 - — Während des Reinigungsvorgangs können die Oberflächen heißer werden als bei normalem Gebrauch.
 - Es ist empfohlen, Kinder fernzuhalten.
 - — Keinen Dampfreiniger verwenden.
 - — Für das Reinigen der Glastür des Backofens dürfen keine Scheuermittel oder Metallschaber verwendet werden, da durch ihre Verwendung Kratzer auf der Oberfläche oder Sprünge im Glas verursacht werden könnten.
- **WARNUNG:**
 - Vor Austausch der Lampe sicherstellen, dass die Strom-



zufuhr abgeschaltet ist, um jegliche Gefahr eines Stromschlags zu vermeiden. Warten, bis das Gerät abgekühlt ist. Zum leichteren Herausdrehen der Lampenabdeckung einen Gummihandschuh verwenden.

-
- Der Netzstecker muss nach der Installation zugänglich sein. Es muss möglich sein, das Gerät vom Stromnetz abzuschalten, entweder durch Ziehen des Netzsteckers, oder durch Einbauen eines Schalters in die fest installierten Leitungen gemäß den Installationsanweisungen.
-
- — Ein beschädigtes Netzkabel muss vom Hersteller, dessen Kundendienst oder einer fachgerecht qualifizierten Person ausgetauscht werden, um jeglicher Gefahr vorzubeugen.
- — Dieses Gerät kann gemäß Einbauanleitung beliebig unter einer Arbeitsplatte installiert oder in einen Hochschrank eingebaut werden.
- — Den Backofen mittig in das Möbel einbauen, so dass ein Mindestabstand von 10 mm zum benachbarten Möbel gewährleistet wird. Das Material des Einbaumöbels muss hitzebeständig sein (oder es muss mit ei-

nem hitzebeständigem Material beschichtet sein). Für eine höhere Stabilität den Backofen mit 2 Schrauben in den vorgesehenen Löchern an den Seitenträgern befestigen.

- — Das Gerät darf nicht hinter einer Dekorationstür installiert werden, um Überhitzung zu vermeiden.
- — Dieses Gerät ist für Haushaltsanwendungen und ähnliche Anwendungen bestimmt wie beispielsweise: Teeküchen für Mitarbeiter von Ladengeschäften, Büros und anderen Arbeitsumfeldern. Landwirtschaftliche Betriebe. Verwendung durch Gäste von Hotels, Motels und anderen Unterkunftszwecken dienenden Einrichtungen.
- — Den Garraum nur bei abgeschaltetem Ofen reinigen.
-
- Die Gerätemerkmale dürfen nicht verändert werden, dies würde für Sie eine Gefahr darstellen.
-
- Benutzen Sie den Ofen nach Nutzung nicht als Vorratskammer oder zur Aufbewahrung von Gegenständen.



UMWELTSCHUTZ

Das Verpackungsmaterial des Gerätes ist recyclingfähig. Führen Sie es der Wiederverwertung zu und leisten Sie einen Beitrag zum Umweltschutz, indem Sie es in den dazu vorgesehenen Containern Ihrer Gemeinde entsorgen.



In das Gerät wurden viele recyclingfähige Materialien eingebaut. Dieses Logo bedeutet, dass Altgeräte nicht zusammen mit anderen Abfällen entsorgt werden dürfen.

Die vom Hersteller organisierte Wiederverwertung erfolgt unter optimalen Bedingungen und hält die europäische Richtlinie 2002/96/EG für Abfälle aus elektrischen und elektronischen Geräten ein.

Fragen Sie in der Gemeindeverwaltung oder bei Ihrem Händler nach den nächstgelegenen Sammelpunkten für Altgeräte.

Wir danken für Ihren Beitrag zum Umweltschutz.

ENERGIESPAR-TIPP

Halten Sie während des Garens die Ofentür geschlossen.



Wahl des aufstellungsorts und einbau

Aus den Abbildungen gehen die Maße eines Möbels hervor, in den der Ofen eingesetzt werden kann.

Dieses Gerät kann ebenso gut unter einer Arbeitsplatte (A) wie in Säulenaufstellung (B) installiert werden. Bei einem offenen Möbel muss die Öffnung hinten maximal 70 mm groß sein. (C et D).

Befestigen Sie den Backofen im Möbel. Dafür die Distanzstücke aus Gummi entfernen und in die Möbelwand ein Loch von 2 mm Durchmesser bohren, um ein Reißen des Holzes zu verhindern. Den Backofen mit den 2 Schrauben befestigen. Setzen Sie die Distanzstücke aus Gummi wieder ein.



Empfehlung

Lassen Sie Ihre Installation von einem Fachmann für Haushaltsgeräte die fachgerechte Installation bestätigen.



Warnung :

Wenn die elektrische Installation in Ihrem Haus geändert werden muss, um Ihr Gerät anzuschließen, wenden Sie sich an einen qualifizierten Elektriker. Wenn der Ofen eine Anomalie aufweist, ziehen Sie den Stecker aus der Steckdose oder entfernen Sie die Sicherung, die der Ofenanschlussleitung entspricht.

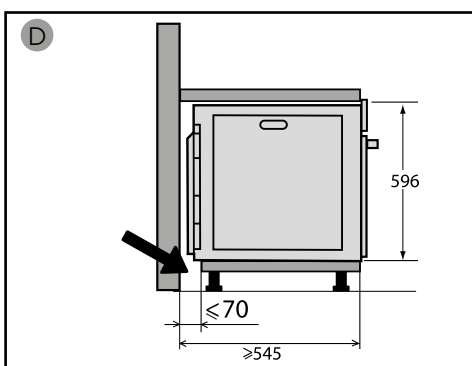
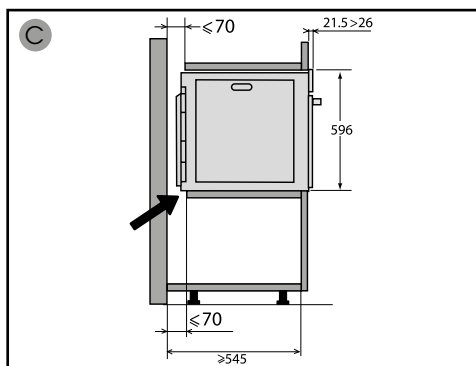
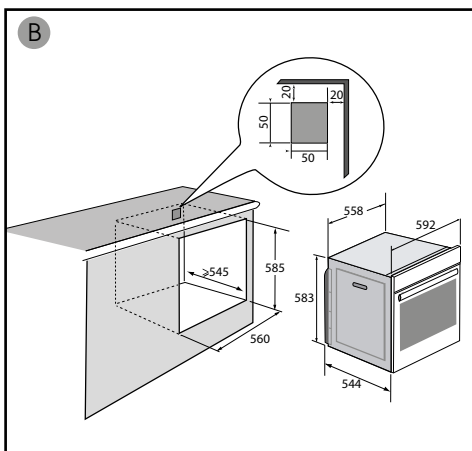
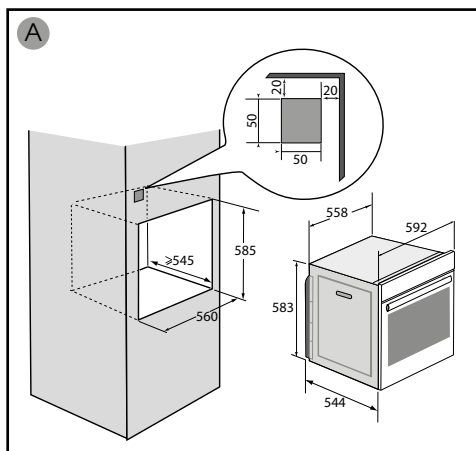



ELEKTRISCHER ANSCHLUSS

Der Herd muss mit einem (genormten) Stromkabel mit 3 Leitern mit 1,5 mm² Leitungsquerschnitt (1 Ph 1 N + Erdung) angeschlossen werden, die an das 220 - 240 V ~ Netz über eine Steckdose nach IEC Norm 60083 oder eine omnipolare Stromunterbrechung gemäß den Installationsregeln angeschlossen sein müssen.



Achtung:

Das Schutzkabel (grün-gelb) ist an den Erdungsanschluss des Gerätes angeschlossen und muss geerdet werden. Die Anlage erfordert eine 16 Ampere-Sicherung.

Wir übernehmen keine Haftung für Unfälle oder Vorkommnisse aufgrund nicht vorhandener, defekter oder nicht ordnungsgemäßer Erdung oder von nicht normgerechtem Anschluss.

• Vor dem ersten Gebrauch

Bevor Sie Ihren Ofen zum ersten Mal benutzen, heizen Sie ihn bei geschlossener Tür etwa 15 Minuten lang bei höchster Temperatur leer, um das Gerät einzubrechen. Die Mineralwolle, die den Ofenraum umgibt, kann aufgrund ihrer Zusammensetzung zunächst einen bestimmten Geruch abgeben. Ebenso können Sie Rauch bemerken. Das alles ist normal.

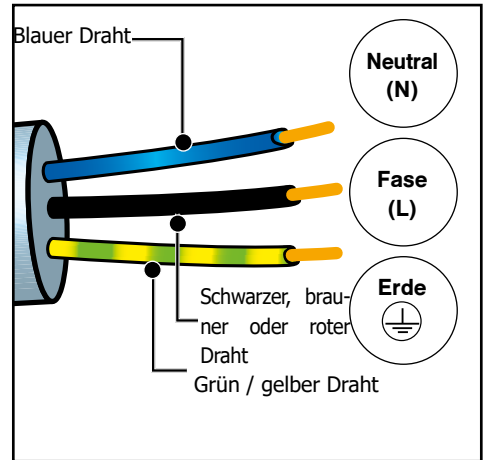



Beschreibung des Ofens

ÜBERSICHT ÜBER DEN BACKOFEN

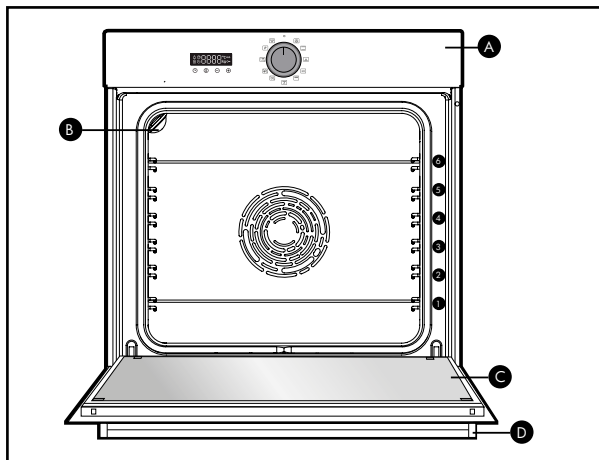

- A** Bedienleiste
- B** Lampe
- C** Tür
- D** Griff

Dieser Backofen verfügt über 6 Einschubleistenpositionen für das Zubehör: Einschubleisten 1 bis 6.

• Anzeige



- Garzeit
- Ende des Garvorgangs
- Verriegelung der Tasten
- Zeitschaltuhr
- Temperaturanzeige
- Vorheizanzeige
- Verriegelung der Tür

• Tasten

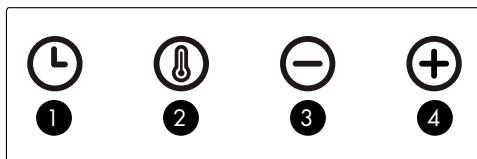

- 1** Einstellung der Uhrzeit und Dauer
- 2** Einstellung der Temperatur
- 3** Taste -
- 4** Taste +



ZUBEHÖR

• Rost mit Kippschutz

Der Rost ist für jede Art von Kochgeschirr und Kuchenform zum Kochen oder Überbacken geeignet. Er wird für Grillgerichte benutzt (sie werden direkt auf den Rost gelegt).

Den Rost mit dem Kippschutz nach hinten in den Ofen einschieben.

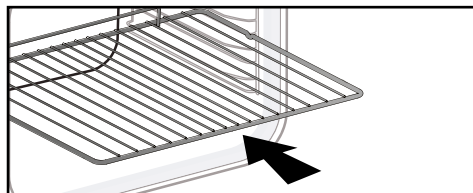

• Mehrzweckblech, Auffangschale 45 mm

Es wird in die unter dem Rost befindlichen Einschubleisten mit dem Griff zur Ofentürseite eingeschoben. Sie fängt Bratensaft und Fett des Grillgutes auf. Zum Garen im Wasserbad kann sie zur Hälfte mit Wasser gefüllt werden.

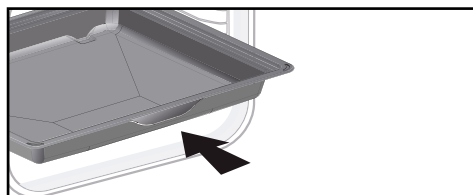

• Kuchenblech 20mm

Es wird in die Einschubleisten mit dem Griff zur Ofentürseite eingeschoben. Ideal zum Backen von Keksen, Mürbegebäck, Cupcakes. Die geneigte Fläche ist ideal zum Ablegen Ihrer zubereiteten Lebensmittel auf einem Blech. Kann auch in die unter dem Rost befindlichen Einschubleisten eingeschoben werden, um den Bratensaft und das Fett des Grillgutes aufzufangen.

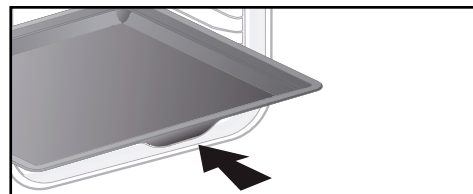

• Auszugschienensystem

Das neue Auszugschienen-System ist praktisch und erleichtert den Umgang mit den Lebensmitteln, da die Bleche sanft herausgezogen werden können, was die Handhabung der Lebensmittel maximal vereinfacht. Die Bleche können ganz herausgezogen werden und bieten vollen Zugriff. Außerdem ist aufgrund der Stabilität vollkommen sichere Bearbeitung und Handhabung der Lebensmittel gegeben, wodurch die Verbrennungsgefahr reduziert wird. So können die Lebensmittel wesentlich einfacher aus dem Ofen geholt werden.

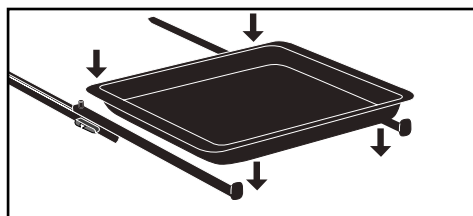

Achtung

Entfernen Sie das Zubehör und die Einschubleisten aus dem Backofen, bevor Sie eine Pyrolysereinigung starten.

Achtung

Unter Hitzeeinwirkung können sich die Zubehörteile verformen, ohne dass ihre Funktion dadurch beeinträchtigt wird. Nach dem Abkühlen nehmen sie ihre ursprüngliche Form wieder an.



EINBAU UND DEMONTAGE DER AUSZUGSCHIENEN

Nach Entfernen der 2 Einschubleisten wählen Sie die Einschubhöhe (von 2 bis 5), in der Sie Ihre Schienen befestigen möchten. Rasten Sie die linke Schiene in die linke Einschubleiste ein und üben Sie auf der Vorderseite und Rückseite der Schiene genügend Druck aus, damit die 2 Winkel auf der Seite der Schiene in die Einschubleiste einrasten. Gehen Sie bei der rechten Schiene gleichermaßen vor.

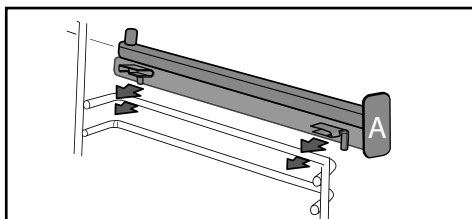

HINWEIS: Der teleskopartige Teil der Schiene muss zur Ofenvorderseite hin ausziehbar sein, der Anschlag **A** befindet sich gegenüber von Ihnen.

Setzen Sie Ihre 2 Einschubleisten ein und platzieren Sie anschließend Ihren Teller auf den 2 Schienen, das System ist betriebsbereit.

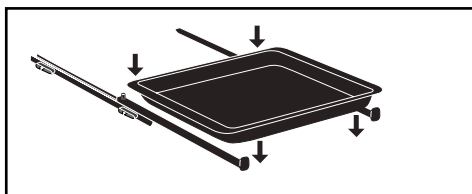

Zur Demontage der Schienen entfernen Sie die Einschubleisten.

Zum Lösen der Winkel von der Einschubleiste ziehen Sie diese leicht nach unten. Ziehen Sie die Schiene zu sich hin.

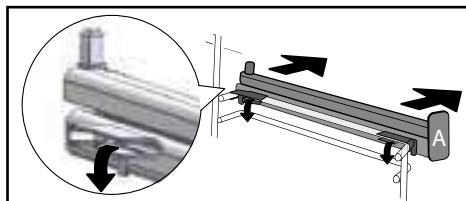

Empfehlung

Um die Rauchbildung beim Garen von fettem Fleisch zu vermeiden, empfehlen wir Ihnen, eine kleine Menge an Wasser oder Öl auf dem Boden der Fettpfanne hinzuzufügen.





Einstellung der Uhrzeit

DIE EINSTELLUNGEN

• Einstellung der Uhrzeit

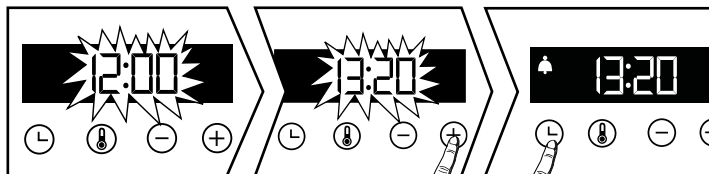
Beim Einschalten des Stroms blinkt die Anzeige auf 12:00.





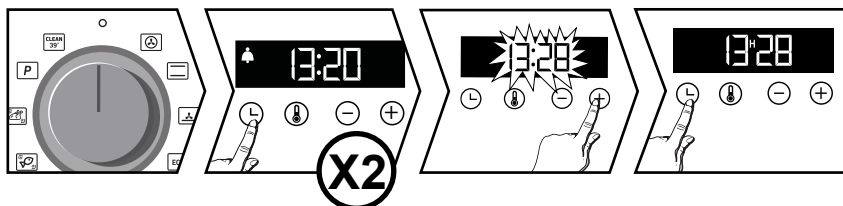

Stellen Sie die Zeit mit den Tasten + oder - ein. Mit der Taste  bestätigen. Bei Stromausfall blinkt die Uhrzeit.

• Änderung der Uhrzeit

Der Schalter für die Funktionswahl muss auf 0 stehen



Drücken Sie die Taste  das symbol  erscheint drücken Sie erneut auf . Stellen Sie die Zeit mit den Tasten + oder - ein. Mit der Taste  bestätigen. Die gewünschte Uhrzeit wird automatisch nach einigen Sekunden abgespeichert.

• Zeitschaltuhr

Diese Funktion kann nur benutzt werden, wenn der Ofen ausgeschaltet ist.

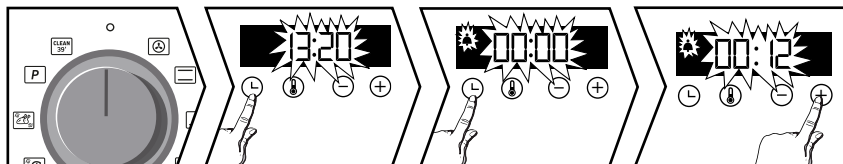

Der Schalter für die Funktionswahl muss auf 0 stehen. Drücken Sie die Taste  das symbol  blinkt.

Stellen Sie die Zeitschaltuhr mit den Tasten + und - ein. Drücken Sie die Taste



 um zu bestätigen, die Rückwärtszählung beginnt.

Hinweis: Sie können die Programmierung der Zeitschaltuhr jederzeit ändern oder annullieren. Zum Löschen zum Menü der Zeitschaltuhr zurückkehren und auf 00:00 einstellen. Ohne Bestätigung geschieht die Registrierung nach einigen Sekunden automatisch.

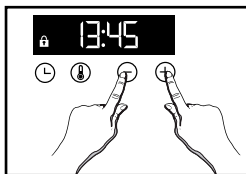

• Verriegelung der tasten





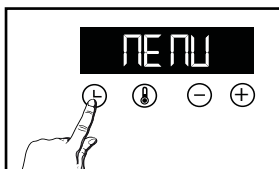

Drücken Sie gleichzeitig die Tasten + und - bis zur Anzeige des Symbols  auf dem Bildschirm. Um zu entsperren, drücken Sie gleichzeitig die Tasten + und -, bis das Symbol  vom Bildschirm verschwindet.

MENÜ

Sie können verschiedene Einstellungen Ihres Backofens verändern, dafür: Drücken Sie die Taste  bis zur "MENÜ"-Anzeige, um zum Einstellmodus zu gelangen.



Drücken Sie erneut die Taste , um die verschiedenen Einstellungen durchlaufen zu lassen. Aktivieren oder deaktivieren Sie mit den Tasten + und - die verschiedenen Einstellungen, siehe folgende Tabelle:

	AUTO: In der Garmethode erlischt die Lampe im Garraum nach 90 Sekunden. ON: In der Garmethode ist die Lampe ständig an.
	Aktivieren/Deaktivieren Sie die Signaltöne der Tasten
	Aktivieren/Deaktivieren Sie den Vorheizmodus
	Aktivieren/Deaktivieren Sie den Vorführmodus

Um das "MENÜ" zu verlassen, drücken Sie erneut auf .



Einstellung der Uhrzeit

GARMETHODEN

Manuelle Funktionen:



UMLUFT*

Temperatur min. 35°C max. 250°C

Empfohlen für zartes helles Fleisch, Fisch und Gemüse. Für gleichzeitige Gar- und Backvorgänge auf bis zu 3 Ebenen.



HERKÖMMLICH

Temperatur min. 35°C max. 275°C

Für langsame und empfindliche Garvorgänge empfohlen: weich gegartes Wildbret. Zum Anbraten von dunklem Fleisch. Zum Schmoren im geschlossenen Kochtopf nach der Vorbereitung auf dem Kochfeld (Hähnchen in Rotweinsauce, Hasenpfeffer).



GEPULSTE HERDBODENFUNKTION

Temperatur min. 75°C max. 250°C

Empfohlen für Backgut mit hohem Feuchtigkeitsgehalt (Quiches, saftige Obstkuchen...). Der Teig wird unten knuspriger. Empfohlen für Backgut mit beim Backen weiter aufgehendem Teig (Kastenkuchen, Hefenapfkuchen, Gugelhupf usw.) und für Soufflés, die so nicht durch eine sich obenauf bildende Kruste gebremst werden.



ECO*

Temperatur min. 35°C max. 275°C

Mit dieser Einstellung kann bei gleich guten Garergebnissen Energie gespart werden. Alle Garvorgänge erfolgen ohne Vorwärmen.



GRILL STARK

Temperatur min. 180°C max. 275°C

Empfohlen, um Toasts zu grillen, ein Gericht zu überbacken, eine Crème brûlée zu bräunen ...



GEPULSTE GRILLFUNKTION

Temperatur min. 100°C max. 250°C

Für saftige(s), rundum knusprige(s) Geflügel und Braten. Die Fettpfanne in die untere Einschubleiste einschieben. Für alle Geflügelsorten oder Braten zum Anbraten und Garen von Lammkeule, Rinderkoteletts empfohlen. Zur Erhaltung des zarten Charakters von Fischkoteletts.

Automatische Funktionen:

Brandt bietet Ihnen 3 neue Funktionen an, die automatisch zwei Garmethoden kombinieren: das traditionelle Garen und das Dampfgaren, um die Nährwerte der Lebensmittel zu erhalten und ein schnelleres Garen zu erreichen.



WEISSES FLEISCH

Empfohlen zur Erhaltung des weichen und zarten Charakters von Schweine- und Kalbsbraten.



FISCH

Empfohlen zum Garen von ganzen Fischen oder von Fischfilets.



GEFLÜGEL

Empfohlen zum Garen von Hähnchen, Truthahn, Perlhuhn und Ente.

Für diese 3 Funktionen müssen Sie nur lauwarmes Wasser in ausreichender Menge in Ihre Schale (Fettpfanne) einfüllen und diese auf die untere Einschubebene in Ihren Ofen stellen und Ihr Gargut auf die Einschubebene 3.

Die Wassermenge, die in die Fettpfanne gegeben werden muss, entnehmen Sie bitte der Tabelle der automatischen Kombifunktionen in Verbindung mit Dampf am Ende der Anleitung.



Ihr Backofen ist mit der Funktion "SMART ASSIST" ausgestattet, die Ihnen bei einer Programmierung der Dauer eine veränderbare Garzeit empfiehlt, gemäß der gewählten Garmethode.

**Garvorgang entsprechend der Vorschriften der Norm EN 60350-1: 2016, als Nachweis der Konformität mit der Energieeffizienzkenzeichnung der europäischen Verordnung UE/65/2014.*



Einstellung der Uhrzeit

KOCHEN BEGINNEN

• Sofortiges garen

Die Programmiervorrichtung darf nur die Uhrzeit anzeigen. Sie darf nicht blinken. Drehen Sie den Funktionswahlschalter auf die Position Ihrer Wahl.

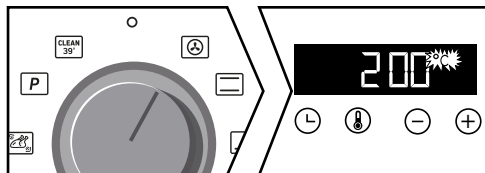

Für die manuellen Funktionen:

Der Temperaturanstieg startet sofort. Ihr Backofen empfiehlt Ihnen eine Temperatur, die Sie jedoch ändern können. Der Backofen heizt auf und die Temperatur-Anzeige blinkt. Bei Erreichen der eingestellten Backofentemperatur ertönt eine Reihe von Signaltönen.

Für die automatischen Funktionen:

 erscheint auf dem Bildschirm.

Wählen Sie Ihr Lebensmittel anhand der Tabelle am Ende der Anleitung aus. Drücken Sie die Tasten + und -, bis das gewünschte Schema auf dem Bildschirm erscheint, und bestätigen Sie mit der Taste .

Ein Gewicht blinkt; geben Sie das tatsächliche Gewicht Ihres Lebensmittels mit den Tasten + und - ein und bestätigen Sie .

Sie müssen nichts weiter einstellen, die Temperatur und die Garzeit werden automatisch berechnet. Das Garzeitende blinkt, bestätigen Sie mit der Taste . Der Garvorgang beginnt sofort.



• Änderung der temperatur

Drücken Sie auf .

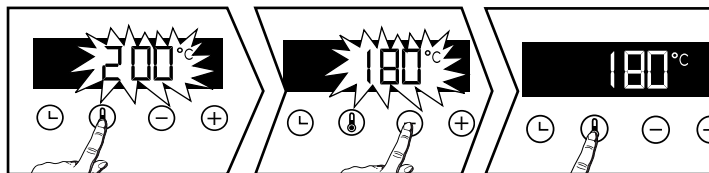
Regeln Sie die Temperatur mit + oder -. Durch Drücken auf  bestätigen.



• Programmierung der dauer

Führen Sie einen sofortigen Garvorgang durch und drücken Sie anschließend auf , la durée de cuisson  ich. Drücken Sie auf + oder -, um die Garzeit einzustellen.

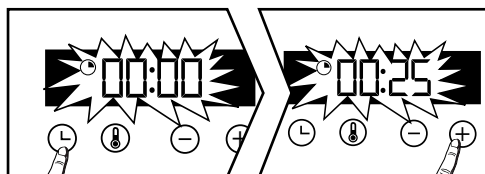



Einstellung der Uhrzeit



Ihr Backofen ist mit der Funktion "SMART ASSIST" ausgestattet, die Ihnen bei einer Programmierung der Dauer eine veränderbare Garzeit empfiehlt, gemäß der gewählten Garmethode. Siehe folgende Tabelle:

Das gewünschte Ende der Garzeit wird automatisch nach einigen Sekunden abgespeichert. Der Countdown für die eingestellte Dauer läuft sofort, sobald die Gartemperatur erreicht ist.

GAR FUNKTION	EMPFEHLUNG DER ZEIT
	30 min
	30 min
	30 min
	30 min
	7 min
	15 min

• Zeitlich verzögert beginnender Garvorgang

Wie bei programmierter Dauer vorgehen. Nach dem Einstellen der Gardauer drücken Sie auf Taste , das Garzeitende blinkt.

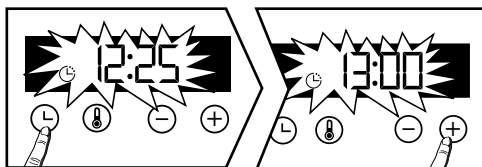

Die Anzeige blinkt, stellen Sie das Garzeitende mit + oder - ein.

Das gewünschte Ende der Garzeit wird automatisch nach einigen Sekunden abgespeichert. Die Anzeige für die Garzeitbeendigung blinkt nicht mehr.



INNEN - AUSSENREINIGUNG

• Reinigung des Hohlraums durch Pyrolyse





Achtung

Entfernen Sie das Zubehör und die Einschubleisten aus dem Backofen, bevor Sie eine Pyrolysereinigung starten. Vor der Pyrolysereinigung Ihres Backofens evtl. vorhandene, starke Verkrustungen entfernen. Entfernen Sie überschüssiges Fett auf der Tür mithilfe eines feuchten Schwamms.

Aus Sicherheitsgründen erfolgt der Pyrolysereinigungsvorgang erst nach automatischer Sperrung der Backofentür, die Tür kann nicht mehr geöffnet werden.

• Sofortige Selbstreinigung

Die Programmiervorrichtung muss die Uhrzeit anzeigen, ohne zu blinken. Wählen Sie mit dem Funktionswahlschalter einen der Selbstreinigungszyklen  oder  aus:

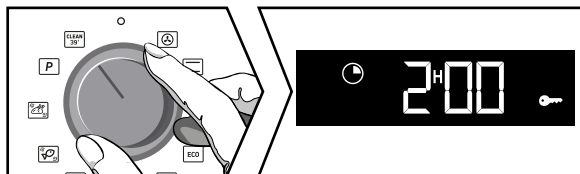



= **Reinigung in 39 Minuten**

- Am Ende eines jeden Garvorgangs scrollt „Clean 39“ auf dem Bildschirm, um Sie aufzufordern, den Reinigungsprozess zu starten. Stellen Sie den Funktionswahlschalter auf diese Funktion und bestätigen Sie mit der Taste . Die Dauer 0:39 wird abwechselnd mit „Clean 39“ angezeigt, die Reinigung beginnt. Nach einigen Minuten erscheint ein Schlüssel und die Ofentür wird zur Sicherheit während des gesamten Programms automatisch verriegelt.

Wenn Sie einen „Clean 39“-Vorgang bei kaltem oder noch nicht ausreichend aufgeheiztem Backofen starten möchten, lassen die Programmstartbedingungen diese Reinigung nicht zu. 0:00 erscheint auf dem Bildschirm, Sie müssen dann die andere Selbstreinigungsposition  wählen.

= Wahlweise 2-stündige Pyrolyse. Stellen Sie den Funktionswahlschalter auf diese Funktion.



Stellen Sie den Funktionswahlschalter auf diese Funktion.  erscheint auf dem Bildschirm. Drücken Sie +, um die Pyrolyse entsprechend dem Verschmutzungsgrad des Backofens zu wählen.

Je nach Auswahl wird die Dauer 2:00 angezeigt. Mit der Taste  bestätigen.  erscheint auf dem Bildschirm, die Pyrolyse beginnt.

Nach erfolgter Reinigung erscheint auf der Anzeige 0:00 und die Tür wird entriegelt.

Stellen Sie den Funktionswahlschalter wieder auf 0 zurück.

• Selbstreinigung mit Startverzögerung

Sie haben die Möglichkeit, den Start der Pyrolyse zu verzögern. Wenn die Programmdauer auf dem Bildschirm angezeigt wird, drücken Sie die Taste  und stellen Sie mit den Tasten + und - die neue Enduhrzeit ein und bestätigen Sie mit . Die Selbstreinigung beginnt später und endet zu der neu programmierten Uhrzeit. Stellen Sie nach erfolgter Reinigung den Funktionswahlschalter wieder auf 0 zurück.



• Reinigung der aussenfläche

Benutzen Sie ein weiches, mit Glasreiniger getränktes Tuch. Weder Scheuermittel noch Scheuerschwamm verwenden.

• Ausbau der einschubleisten

Zerlegen Sie die Stufendrähle, um sie zu reinigen. Heben Sie den vorderen Teil der Stufe an. Schieben Sie die gesamte Stufe nach oben und lösen Sie den vorderen Haken aus dem Gehäuse. Ziehen Sie dann die gesamte Stufe leicht in Ihre Richtung, um die hinteren Haken von ihrem Gehäuse zu lösen. Entfernen Sie die 2 Schritte.

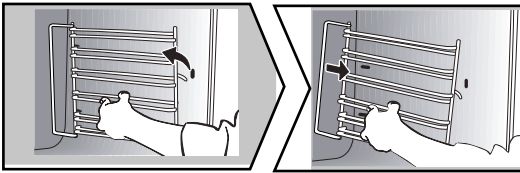

• Reinigung der inneren scheiben



Warnung

Für das Reinigen der Glastür des Ofens dürfen keine Scheuermittel, Scheuerschwämme oder Metallschaber verwendet werden, wodurch Kratzer auf der Oberfläche oder Sprünge im Glas verursacht werden könnten.

Nehmen Sie zum Reinigen der inneren Scheiben die Tür ab. Entfernen Sie vor dem Herausnehmen der Scheiben das überschüssige Fett auf der inneren Scheibe mit einem weichen Tuch und Spülmittel.

• Reinigung der inneren scheiben

Öffnen Sie die Tür vollständig und blockieren Sie sie mithilfe des Plastikkeils, das in der mit dem Gerät gelieferten Plastiktüte enthalten ist.

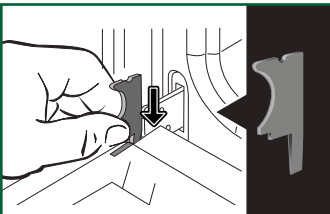

Entfernen Sie die erste mit Clip befestigte Scheibe:

Drücken Sie mithilfe eines Werkzeugs (Schraubendreher) in die Öffnungen **A**, um die Scheibe aus der Cliphalterung zu lösen.



Warnung

Stellen Sie sicher, dass Sie die Montagerichtung dieses ersten Fensters markieren (glänzende Seite zu Ihnen)



Je nach Modell besteht die Tür aus zwei zusätzlichen Scheiben mit einem schwarzen Abstandsbolzen aus Gummi an jeder Ecke. Falls nötig, entfernen Sie diese, um sie zu reinigen. Die Scheiben nicht in Wasser tauchen. Mit klarem Wasser spülen und mit einem nicht fuselnden Tuch trocknen.

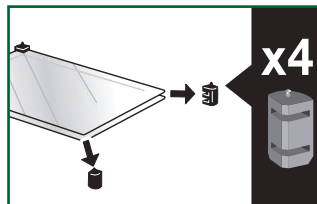
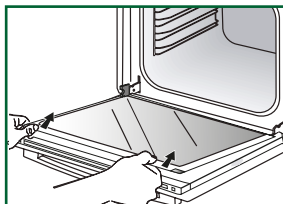
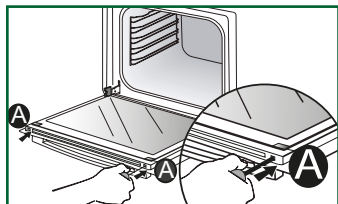

• Wiedereinsetzen der tür

Stellen Sie die vier schwarzen Distanzstücke aus Gummi nach der Reinigung wieder mit dem Pfeil nach oben zurück und bringen Sie alle Scheiben wieder an. Rasten Sie die letzte Scheibe in die Distanzstücke aus Metall ein, befestigen Sie sie dann mit der glänzenden Seite nach außen.

Entfernen Sie den Plastikkeil. Ihr Gerät ist nun wieder betriebsbereit.

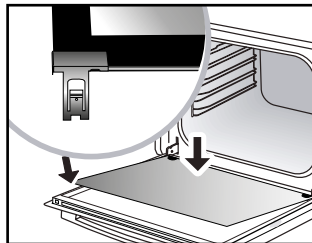
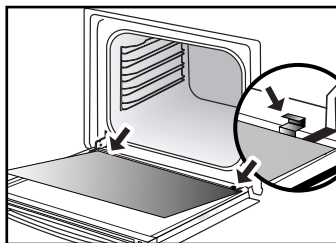
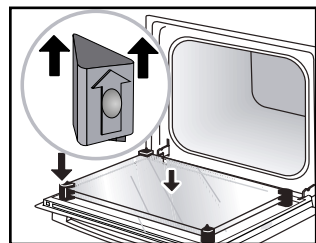

• Ersetzen der Lampe



Warnung:

Um die Gefahr eines Stromschlags auszuschließen, vor Austausch der Lampe sicherstellen, dass die Stromversorgung des Ofens abgeschaltet ist. Den Eingriff nur bei kaltem Ofen

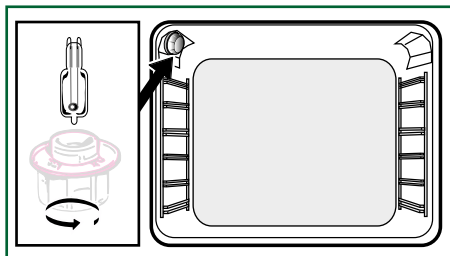

Techn. Daten der Glühlampe:

15 W, 220-240 V~, 300°C, Sockel G9.

Die Glasabdeckung und die Lampe lassen sich leichter herausdrehen, wenn ein Gummihandschuh getragen wird.



FUNKTIONSSTÖRUNGEN UND LÖSUNGEN

Der Backofen heizt nicht.

Kontrollieren Sie, ob der Ofen tatsächlich an das Stromnetz angeschlossen ist und ob die Sicherung Ihrer Elektroinstallation intakt ist. Höhere Temperatur einstellen.

Die Lampe des Backofens funktioniert nicht.

Tauschen Sie die Lampe bzw. die Sicherung aus. Kontrollieren Sie, ob der Ofen tatsächlich an das Stromnetz angeschlossen ist.

Das Kühlgebläse läuft nach Abschalten des Backofens weiter. Das ist normal, die Ventilation kann bis maximal eine Stunde nach dem Garen weiterlaufen, um die Innen- und die Außentemperatur des Ofens abzusenkten. Wenn das Kühlgebläse länger als eine Stunde weiterläuft, wenden Sie sich bitte an den Kundendienst.

Die Pyrolysereinigung wird nicht ausgeführt.

Überprüfen, ob die Backofentür geschlossen ist. Wenn ein Fehler beim Sperren der Tür oder ein Temperatur-Sensor-Fehler vorliegt, wenden Sie sich bitte an den Kundendienst.

Das Symbolblinkt auf der Anzeige.

Fehler beim Sperren der Tür; bitte wenden Sie sich an den Kundendienst.

Vibrierendes Geräusch.

Stellen Sie sicher, dass das Netzkabel keinen Kontakt mit der Rückwand hat.

Dies hat keine Auswirkungen auf die ordnungsgemäße Funktion Ihres Geräts, kann jedoch während der Belüftung zu Vibrationsgeräuschen führen. Entfernen Sie Ihr Gerät und bewegen Sie das Kabel. Ersetzen Sie Ihren Backofen.



REPARATURARBEITEN

Eventuelle Reparaturarbeiten an dem Gerät müssen von qualifiziertem Fachpersonal des Händlers vorgenommen werden. Um bei Ihrem Anruf die Entgegennahme Ihres Anliegens zu erleichtern, halten Sie bitte die vollständigen Geräteangaben bereit (Handels-Referenznummer, Service-Referenznummer, Seriennummer). Diese Angaben finden Sie auf einem an Ihrem Gerät angebrachten Schild.

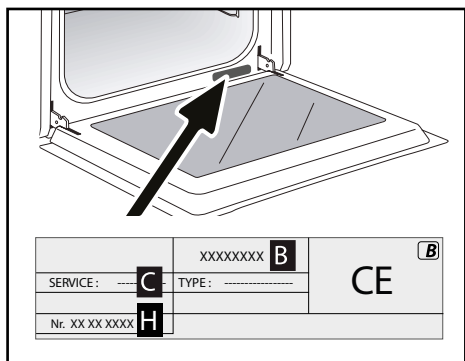

B: Handelsreferenznummer

C: Service-Referenznummer

H: Seriennummer

ORIGINAL-ERSATZTEILE

Verlangen Sie bei Reparaturarbeiten, dass ausschließlich zertifizierte Original-Ersatzteile verwendet werden.





GERICHTE	* * * * * * * *												min	
Fleisch														
Schweinebraten (1kg)	200	2					180	2					60	
Kalbsbraten (1kg)	200	2					180	2					60-70	
Rinderbraten	240	2											30-40	
Lamm (Keule, Schulter 2,5 kg)	220	1			220					200	2		60	
Geflügel (1 kg)	200	2			220		180	2		210	3		60	
Große Geflügelstücke	180	1											60-90	
Hähnchenschenkel						3				210	3		20-30	
Schweine-/Kalbskotelett					210	3							20-30	
Rinderkotelett (1kg)					210	3				210	3		20-30	
Schafskotelett					210	3							20-30	
Fisch														
Gegrillter Fisch					275	4							15-20	
Fischgerichte	200	3					180	3					30-35	
Geararter Fisch	220	3					200	3					15-20	
Gemüse														
Aufläufe (gegarte Lebensmittel)					275	2							30	
Kartoffelaufbau	200	2					180	2					45	
Lasagne	200	3					180	3					45	
Gefüllte Tomaten	170	3					160	2					30	
Gebäck														
Biskuit - Biskuitkuchen			180	2								180	2	35
Biskuitrolle	220	3										180	2	5-10
Brioche	180	1	210									180	2	35-45
Brownies	180	2					175	3						20-25
Kuchen - Sandkuchen	180	1	180	1								180	2	45-50
Clafoutis	200	2					180	3						30-35
Cremes	165	2										150	2	30-40

* Je nach Modell



GERICHTE	* * * * * * *										min							
Gebäck																		
Madeleines	220	3					200	3										5-10
Windbeutel	200	3					180	3						180	3			30-40
Blätterteigteilchen	220	3					200	3										5-10
Savarin	180	3												175	3			30-35
Mürbeteig-Tarte	200	1					195	1										30-40
Feine Blätterteig-Tarte	215	1					200	1										20-25
Mürbeteig-Tarte mit Hefe	210	1					200	1										10-30
Verschiedenes																		
Spießbraten	220	3			210	4												10-15
Schüsselpastete	200	2					190	2										80-100
Mürbeteig-Pizza	200	2																30-40
Brotteig-Pizza																		15-18
Quiches																		35-40
Soufflé													180	2				50
Pasteten	200	2																40-45
Brot	220						200		220									30-40
Gegrilltes Brot	180				275	4-5												2-3
Gerichte im Schmortopf (Schmorbraten)	180	2												180	2			90-180

* Je nach Modell



Alle Temperatur- und Gardauerangaben gelten für vorgeheizte Öfen.

Hinweis: Alle Fleischarten müssen mindestens 1 Stunde bei Raumtemperatur liegen, bevor sie in den Backofen geschoben werden.

ENTSPRECHUNG: ZIFFERN T °C									
°C	30	60	90	120	150	180	210	240	275
Ziffern	1	2	3	4	5	6	7	8	9 max

Rezepte mit Hefe (je nach Modell)

Zutaten:

- Mehl 2 kg
- Wasser 1240 ml
- Salz 40 g
- 4 Päckchen getrocknete Backhefe

Den Teig mit dem Mixer vermischen und im Ofen aufgehen lassen.

Durchführung: Für Rezepte mit Hefeteig. Füllen Sie den Teig in eine hitzebeständige Schüssel, entfernen Sie die Einschubleistenhalterungen und stellen Sie die Schüssel auf dem Backofenboden ab.

Heizen Sie den Backofen mit der Umluftfunktion bei 40-50 °C 5 Minuten lang vor. Schalten Sie den Backofen aus und lassen Sie den Teig 25-30 Minuten in der Restwärme aufgehen.

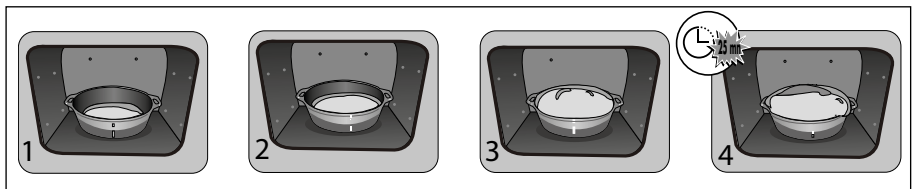

VERFAHREN ZUR MESSUNG DER GEBRAUCHSEIGENSCHAFTEN LAUT NORM IEC 60350











NAHRUNGSMITTEL	* GAR-EINSTELLUNG	POSITION	ZUBEHÖR	t °C	DAUER Min.	VORHEIZEN
Spritzgebäck (8.4.1)		5	Backblech 45 mm	150	30-40	ja
Spritzgebäck (8.4.1)		5	Backblech 45 mm	150	25-35	ja
Spritzgebäck (8.4.1)		2 + 5	Backblech 45 mm + Rost	150	25-45	ja
Spritzgebäck (8.4.1)		3	Backblech 45 mm	175	25-35	ja
Spritzgebäck (8.4.1)		2 + 5	Backblech 45 mm + Rost	160	30-40	ja
Small cakes (8.4.2)		5	Backblech 45 mm	170	25-35	ja
Small cakes (8.4.2)		5	Backblech 45 mm	170	25-35	ja
Small cakes (8.4.2)		2 + 5	Backblech 45 mm + Rost	170	20-40	ja
Small cakes (8.4.2)		3	Backblech 45 mm	170	25-35	ja
Small cakes (8.4.2)		2 + 5	Backblech 45 mm + Rost	170	25-35	ja
Wasserbiskuitorte (8.5.1)		4	Rost	150	30-40	ja
Wasserbiskuitorte (8.5.1)		4	Rost	150	30-40	ja
Wasserbiskuitorte (8.5.1)		2 + 5	Backblech 45 mm + Rost	150	30-40	ja
Wasserbiskuitorte (8.5.1)		3	Rost	150	30-40	ja
Wasserbiskuitorte (8.5.1)		2 + 5	Backblech 45 mm + Rost	150	30-40	ja
Gedeckter Apfelkuchen (8.5.2)		1	Rost	170	90-120	ja
Gedeckter Apfelkuchen (8.5.2)		1	Rost	170	90-120	ja
Gedeckter Apfelkuchen (8.5.2)		3	Rost	180	90-120	ja
Toast bräunen (9.2.2)		5	Rost	275	3-6	ja

* Modellabhängig

HINWEISS: Beim Garen auf 2 Ebenen können die Gerichte nach unterschiedlichen Zeiten herausgenommen werden.



TABELLE DER AUTOMATISCHEN KOMBIFUNKTIONEN IN VERBINDUNG MIT DAMPF

Position des Bedienschalters	Anzeige in der Programmiervorrichtung	Lebensmittel	Hinzuzugebende Wassermenge
		Hähnchen	500 ml lauwarmes Wasser in der Fettpfanne
		Ente	500 ml lauwarmes Wasser in der Fettpfanne
		Truthahn	500 ml lauwarmes Wasser in der Fettpfanne
		Perlhuhn	800 ml lauwarmes Wasser in der Fettpfanne
		Ganze Fische (groß)	500 ml lauwarmes Wasser in der Fettpfanne
		Ganze Fische (flach)	300 ml lauwarmes Wasser in der Fettpfanne
		Kleine ganze Fische	300 ml lauwarmes Wasser in der Fettpfanne
		Fischfilets	300 ml lauwarmes Wasser in der Fettpfanne

WICHTIG

Stellen Sie die Fettpfanne (mit lauwarmem Wasser) auf die untere Einschubebene 1 und Ihr Gargut auf die Einschubebene 3.



EN	Información for domestic ovens (UE n° 662014)	DE	Informationen zu Haushaltsbacköfen (UE n° 662014)
FR	Informations concernant les fours domestiques (UE n° 662014)	ES	Información sobre los hornos domésticos (UE n° 662014)
CS	Informace týkající se trou pro domácnosti (UE n° 662014)	IT	Informazione relative ai forni per uso domestico (UE n° 662014)
DA	Oplysninger for ovne til husholdningsbrug (UE n° 662014)	NL	Informatie met betrekking tot huishoudelijke ovens (UE n° 662014)
EL	Πληροφορίες για οικιακά φούρνους (UE n° 662014)	FI	koteloitten uunien tiedot (UE n° 662014)

Symbol	Value	Unit	EN	FR	DE	ES	CS	DA	EL	IT	NL	FI
KCD2SP												
KCD2ST												
KH72SP												
KH72ST												
KH75SP												
KH75ST												
KH78SP												
KH78ST												
KH79SP												
KH79ST												
KH73W												
KH74W												
KH75W												
KH76W												
KH77W												
Type norme												
Models identification												
Type of oven	Simple	FR: Impuls-ES: Automatische DA: Einzel-DE: Einzel-ES: Simple-IT: Semplice-NL: Simple-P: PoliposuzP-T: Simple-SK: Jednoduchostřel-EL: ΑπλόCF: Yksitoiminen-SV: Enkel										
Mass of the appliance	M	34,6 30,7 35,7 33,6 36,2 36,6 36,0 33,6 36,6 38,0 38,0 38,0 43,1	kg									
Number of cavities		1 1 1 1 1 1 1 1 1 1 1 1 1										
Heat source per cavity (type of fuel or gas)			FR: Electricité-ES: Electricidad-DE: Strom-E: Electricidad-IT: Energia elettrica-NL: Elektriciteit-Electricity-PT: Energia elétrica-SK: Elektrická-EL: Ηλεκτρική-EN: Electric									
Volume per cavity	V	73,0 73,0 73,0 73,0 73,0 73,0 73,0 73,0 73,0 73,0 73,0 73,0	l									
Energy consumption (mode per cavity) required to heat a standardised load in electric mode during a cycle in fan-forced	EC	0,82 0,82 0,69 0,70 0,70 0,70 0,70 0,70 0,70 0,70 0,70 0,70	kWh/cycle									
Energy efficiency index per cavity (electric final energy)	EEl	90,3 86,3 80,2 81,4 81,4 81,4 81,4 81,4 81,4 81,4 81,4 81,4										

FR

CS

DA

DE

EL

EN

ES

FI

IT

NL

NO

PL

PT

SK

SV

Brandt



ΟΔΗΓΙΕΣ ΧΡΗΣΗ EL

ΦΟΥΡΝΟΣ

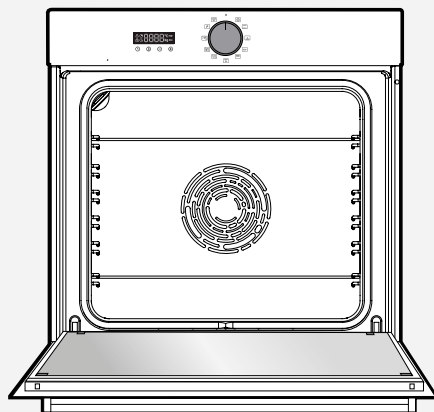

ORIGINE
FRANCE[®]
GARANTIE

BVCert.6011825

Αγαπητέ Πελάτη,

Μόλις αγοράσατε ένα προϊόν **BRANDT** και θα θέλαμε να σας ευχαριστήσουμε. Η σχεδίαση και η κατασκευή αυτού του προϊόντος πραγματοποιήθηκε λαμβάνοντας υπόψη εσάς, τον τρόπο ζωής και τις απαιτήσεις σας προκειμένου το προϊόν να ικανοποιήσει τις προσδοκίες σας. Αξιοποιούμε την τεχνογνωσία μας, το καινοτόμο πνεύμα και το πάθος μας που μας καθοδηγεί για περισσότερα από 60 χρόνια.

Σε μια προσπάθεια να διασφαλίσουμε ότι τα προϊόντα μας ανταποκρίνονται στις απαιτήσεις σας με τον καλύτερο δυνατό τρόπο, το Τμήμα Εξυπηρέτησης Πελατών είναι στη διάθεσή σας, για να απαντήσει σε όλες τις ερωτήσεις σας και να ακούσει όλες τις προτάσεις σας.

Επισκεφθείτε την ιστοσελίδα μας **www.brandt.com** όπου θα βρείτε τις τελευταίες μας καινοτομίες, καθώς και χρήσιμες και συμπληρωματικές πληροφορίες.

H BRANDT με χαρά σας βοηθάει καθημερινά και ελπίζει να αξιοποιήσετε στο μέγιστο την αγορά σας.



Η ετικέτα "Origine France Garantie" παρέχει στους καταναλωτές την γνησιασμότητα ενός προϊόντος δίνοντας μια σαφή και αντικειμενική ένδειξη προέλευσης. Η μάρκα BRANDT είναι υπερήφανη που τοποθετεί αυτήν την ετικέτα σε προϊόντα από τα γαλλικά εργοστάσιά μας που εδρεύουν στην Ορλεάνη και τη Vendôme.

<https://brandt.fr/>

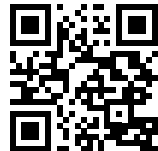

 **Σημαντικό:**
Πριν να χρησιμοποιήσετε τη συσκευή σας, διαβάστε αυτές τις οδηγίες χρήσης προσεκτικά για να εξοικειωθείτε πιο γρήγορα με τη λειτουργία του.



Οδηγίες ασφαλείας	4
ΠΕΡΙΒΑΛΛΟΝ ΚΑΙ ΕΞΟΙΚΟΝΟΜΗΣΗ	6
Περιβάλλον	6
Συμβουλή εξοικονόμησης ενέργειας	6
εγκατάσταση της συσκευής σας	7
Επιλογή θέσης και εγκατάστασης	7
Ηλεκτρική σύνδεση	8
Περιγραφή της συσκευής σας	9
Παρουσίαση του φούρνου	9
Πλήκτρα οθόνης και ελέγχου	9
Αξεσουάρ	10
Χρήση της συσκευής σας	12
Ρυθμίσεις	12
Μενού ρυθμίσεων	13
Τρόποι μαγειρέματος	14
Έναρξη μαγειρέματος	15
Φροντίδα της συσκευής σας	17
Εσωτερικός - εξωτερικός καθαρισμός	18
Ανωμαλίες και λύσεις	19
Υπηρεσία μεταπωλήσεων	21
Παρεμβάσεις	21
ΒΟΗΘΕΙΑ ΜΑΓΕΙΡΕΜΑΤΟΣ	21
Διαγράμματα μαγειρέματος	22
Συνταγές με μαγιά	24
Δοκιμές λειτουργικής ικανότητας	25
Λειτουργεί με αυτόματο συνδυασμένο ατμό	26



ΣΗΜΑΝΤΙΚΕΣ ΟΔΗΓΙΕΣ ΑΣΦΑΛΕΙΑΣ. ΔΙΑΒΑΣΤΕ ΤΕΣ ΜΕ ΠΡΟΣΟΧΗ ΚΑΙ ΦΥΛΑΞΤΕ ΤΕΣ ΓΙΑ ΜΕΛΛΟΝΤΙΚΕΣ ΧΡΗΣΕΙΣ.

Αυτές οι οδηγίες χρήσης διατίθενται προς μεταφόρτωση στην ιστοσελίδα της κατασκευάστριας εταιρείας.

- Σημαντικό:
- Όταν λάβετε τη συσκευή, αφαιρέστε αμέσως τη συσκευασία. Ελέγξτε καλά όλη τη συσκευή. Σημειώστε τυχόν προβληματισμούς ή επιφυλάξεις στο δελτίο παράδοσης και φροντίστε να κρατήσετε αντίγραφο αυτού του εντύπου. Πριν θέσετε σε λειτουργία τη συσκευή σας, διαβάστε αυτόν τον οδηγό εγκατάστασης προσεκτικά για να εξοικειωθείτε με τη λειτουργία του. Φυλάξτε αυτές τις οδηγίες χρήσης με τη συσκευή σας. Εάν η συσκευή πωληθεί ή μεταβιβαστεί σε άλλο άτομο, βεβαιωθείτε ότι ο νέος ιδιοκτήτης θα λάβει αυτές τις οδηγίες χρήσης.
- Θα πρέπει να εξοικειωθείτε με τις συστάσεις πριν να εγκαταστήσετε και χρησιμοποιήσετε το φούρνο σας. Έχουν συνταχθεί για την ασφάλεια σας και την ασφάλεια των άλλων.
-
- — Αυτός ο φούρνος σχεδιάστηκε για οικιακή χρήση από ιδιώτες. Ο φούρνος δεν περιέχει εξαρτήματα αμιάντου.
- — Η συσκευή σας προορίζεται για τυπική οικιακή χρήση. Μην την χρησιμοποιείτε για επαγγελματικούς ή βιομηχανικούς σκοπούς ή για οποιοδήποτε άλλο σκοπό πέραν από αυτόν για τον οποίο σχεδιάστηκε.
- — Μην τροποποιήσετε ή μην επιχειρήσετε να τροποποιήσετε οποιοδήποτε από τα χαρακτηριστικά αυτής της συσκευής. Κάτι τέτοιο μπορεί να ενέχει κίνδυνο για την ασφάλειά σας.
- — Μην τοποθετείτε ποτέ αλουμινοχαρτο απευθείας στο δάπεδο του φούρνου καθώς η συσσώρευση θερμότητας ενδέχεται να καταστρέψει την εμαγιέ επιφάνεια.
- — Μην τοποθετείτε βαριά αντικείμενα πάνω στην ανοιχτή πόρτα του φούρνου και βεβαιωθείτε ότι τα παιδιά δεν μπορούν να σκαρφαλώσουν ή να καθίσουν πάνω της.
- — Μην χρησιμοποιείτε το φούρνο σας ως χώρο αποθήκευσης τροφίμων ή για να αποθηκεύσετε οποιαδήποτε αντικείμενα μετά τη χρήση.
- — Μετά τη χρήση του φούρνου σας, βεβαιωθείτε ότι όλα τα στοιχεία ελέγχου είναι στη θέση διακοπής λειτουργίας.
- — Ο φούρνος πρέπει να είναι απενεργοποιημένος όταν καθαρίζετε το εσωτερικό του.
- — Πριν αφαιρέσετε το γυάλινο παράθυρο, αφήστε τη συσκευή να κρυώσει τελείως.
-



ΟΔΗΓΙΕΣ ΑΣΦΑΛΕΙΑΣ

- Η συσκευή αυτή μπορεί να χρησιμοποιηθεί από παιδιά 8 ετών και άνω, και από άτομα με μειωμένες σωματικές, αισθητήριες ή διανοητικές ικανότητες ή χωρίς εμπειρία και γνώση, εάν επιτηρούνται ή έλαβαν οδηγίες για την ασφαλή χρήση της συσκευής και κατανόησαν τον κίνδυνο που μπορεί να υπάρχει. Τα παιδιά δεν πρέπει να παίζουν με τη συσκευή. Οι ενέργειες καθαρίσματος και συντήρησης δεν πρέπει να πραγματοποιούνται από παιδιά που δεν επιτηρούνται.
- — Φροντίζετε να επιβλέπετε τα παιδιά προκειμένου να μην παίζουν με τη συσκευή.
- **ΠΡΟΕΙΔΟΠΟΙΗΣΗ:** Η συσκευή και τα προσβάσιμα μέρη της θερμαίνονται κατά τη διάρκεια της χρήσης. Προσέξτε να μην αγγίζετε τα θερμαντικά στοιχεία που βρίσκονται στο εσωτερικό του φούρνου. Τα παιδιά κάτω των 8 ετών πρέπει να παραμένουν μακριά εκτός και αν βρίσκονται υπό διαρκή επίβλεψη.
- — Αυτή η συσκευή έχει σχεδιαστεί για ψήσιμο με κλειστή πόρτα.
- — Πριν προβείτε στον καθαρισμό του φούρνου σας με πυρόλυση, αφαιρέστε όλα τα εξαρτήματα και καθαρίστε τους πιο έντονους λεκέδες.
- — Κατά τη λειτουργία καθαρισμού, οι επιφάνειές της συσκευής ενδέχεται να θερμανθούν περισσότερο απ' ό τι συνήθως. Συνιστάται να απομακρύνετε τα παιδιά.
- — Μην χρησιμοποιείτε συσκευή καθαρισμού με ατμό.
- — Πριν αφαιρέσετε την πίσω επιφάνεια, η συσκευή πρέπει να αποσυνδεθεί από την παροχή ηλεκτρικού ρεύματος. Μετά τον καθαρισμό, η πίσω επιφάνεια πρέπει να τοποθετηθεί στη θέση της, σύμφωνα με τις οδηγίες.
- — Μην χρησιμοποιείτε αποξεστικά προϊόντα συντήρησης ή σκληρά μεταλλικά σφουγγάρια για να καθαρίζετε την γυάλινη πόρτα του φούρνου καθώς ενδέχεται να χαρακωθεί η επιφάνεια και να σπάσει το γυαλί.
-
-
- **ΠΡΟΕΙΔΟΠΟΙΗΣΗ:** Βεβαιωθείτε ότι η συσκευή είναι αποσυνδεδεμένη από την παροχή ηλεκτρικού ρεύματος, πριν να αντικαταστήσετε τη λυχνία προκειμένου να αποφύγετε τον κίνδυνο ηλεκτροπληξίας. Προβείτε στην αλλαγή αφού κρυώσει η συσκευή. Για να ξεβιδώνετε το κάλυμμα της λυχνίας, χρησιμοποιείτε ένα γάντι από καουτσούκ, το οποίο θα διευκολύνει την αποσυναρμολόγηση.
-
-
- Φροντίστε να έχετε πρόσβαση στο φως τροφοδοσίας μετά την εγκατάσταση.
- Είναι δυνατό να αποσυνδέσετε την συσκευή από το δίκτυο ηλεκτρικής τροφοδοσίας, είτε μέσω ενός ρευματολήπτη, είτε χρησιμοποιώντας ένα διακόπτη



ΟΔΗΓΙΕΣ ΑΣΦΑΛΕΙΑΣ

που έχετε τοποθετήσει στις σταθερές σωληνώσεις σύμφωνα με τους κανόνες εγκατάστασης.

- Εάν το καλώδιο τροφοδοσίας έχει φθαρεί πρέπει να αντικατασταθεί από τον κατασκευαστή, την υπηρεσία εξυπηρέτησης πελατών του κατασκευαστή, ή ένα άτομο με παρόμοια εξειδίκευση προκειμένου να διασφαλιστεί πλήρως η ασφάλεια.

- — Αυτή η συσκευή μπορεί να εγκατασταθεί είτε κάτω από ένα πάγκο εργασίας είτε σε ένα έπιπλο, όπως υποδεικνύεται στο σχέδιο εγκατάστασης.

- — Τοποθετήστε τον φούρνο μέσα

στο έπιπλο έτσι ώστε η ελάχιστη απόστασή του από το διπλανό έπιπλο να είναι 10 χιλιοστά. Το υλικό από το οποίο αποτελείται το έπιπλο εντοιχισμού πρέπει να είναι ανθεκτικό στη θερμότητα (ή να είναι επενδεδυμένο με τέτοιο υλικό). Για μεγαλύτερη σταθερότητα, στερεώστε τον φούρνο μέσα στο έπιπλο τοποθετώντας 2 βίδες στις οπές που προορίζονται για το σκοπό αυτό.

- Η συσκευή δεν πρέπει να εγκατασταθεί πίσω από διακοσμητική πόρτα, προς αποφυγή υπερθέρμανσης.



Περιβάλλον και εξοικονόμηση ενέργειας

περιβάλλον

Τα υλικά συσκευασίας για αυτήν τη συσκευή είναι ανακυκλώσιμα. Λάβετε μέρος στην ανακύκλωση τους και, ως εκ τούτου, βοηθήστε στην προστασία του περιβάλλοντος τοποθετώντας τα στα δημοτικά δοχεία που παρέχονται για το σκοπό αυτό.



Η συσκευή σας περιέχει επίσης πολλά ανακυκλώσιμα υλικά. Επομένως, επισημαίνεται με αυτό το λογότυπο για να σας υποδείξει ότι οι χρησιμοποιημένες συσκευές δεν πρέπει να αναμιγνύονται με άλλα απορρίμματα.

Η ανακύκλωση συσκευών που οργανώνει ο κατασκευαστής σας θα πραγματοποιηθεί έτσι υπό τις καλύτερες συνθήκες, σύμφωνα με την ισχύουσα ευρωπαϊκή οδηγία για τα απόβλητα ηλεκτρικού και ηλεκτρονικού εξοπλισμού.

Επικοινωνήστε με το δημαρχείο ή τον πωλητή σας για τα σημεία συλλογής για χρησιμοποιημένες συσκευές που βρίσκονται πιο κοντά στο σπίτι σας. Σας ευχαριστούμε για τη συνεργασία σας στην

Συμβουλή εξοικονόμησης ενέργειας

Κατά το μαγείρεμα, κρατήστε την πόρτα του φούρνου κλειστή.



ΕΠΙΛΟΓΗ ΤΟΠΟΘΕΣΙΑΣ ΚΑΙ ΕΓΚΑΤΑΣΤΑΣΗΣ

Τα διαγράμματα καθορίζουν τις διαστάσεις ενός κομματιού επίπλων που θα φιλοξενήσει το φούρνο σας. Αυτή η συσκευή μπορεί να εγκατασταθεί είτε σε μια στήλη (A) είτε σε έναν μετρητή (B). Εάν το περίβλημα είναι ανοιχτό, το άνοιγμά του πρέπει να είναι το πολύ 70 mm στο πίσω μέρος (C και D). Ασφαλίστε το φούρνο στο ντουλάπι. Για να το κάνετε αυτό, αφαιρέστε τις λαστιχένιες στάσεις και προ-τρυπήστε μια τρύπα mm 2 στον τοίχο του περιβλήματος για να αποφύγετε το σχίσσιμο του ξύλου. Στερεώστε το φούρνο με τις 2 βίδες.

Αντικαταστήστε τις λαστιχένιες στοπ.



Συμβουλές:

Για να είστε σίγουροι ότι έχετε συμβατή εγκατάσταση, μην διστάσετε να καλέσετε έναν ειδικό της συσκευής.



Προειδοποίηση:

Εάν η ηλεκτρική εγκατάσταση στο σπίτι σας απαιτεί τροποποίηση για να συνδέσετε τη συσκευή σας, καλέστε έναν εξειδικευμένο ηλεκτρολόγο. Εάν ο φούρνος παρουσιάζει ανωμαλία, αποσυνδέστε τη συσκευή ή αφαιρέστε την ασφάλεια που αντιστοιχεί στη γραμμή σύνδεσης του φούρνου.

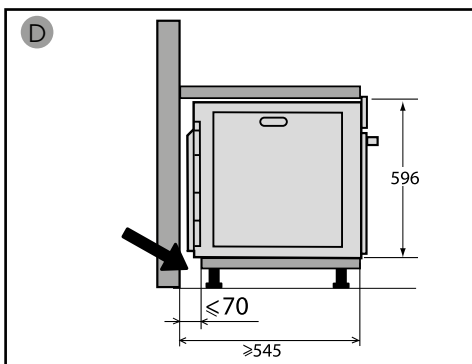
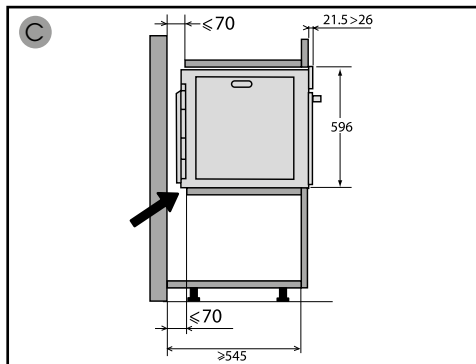
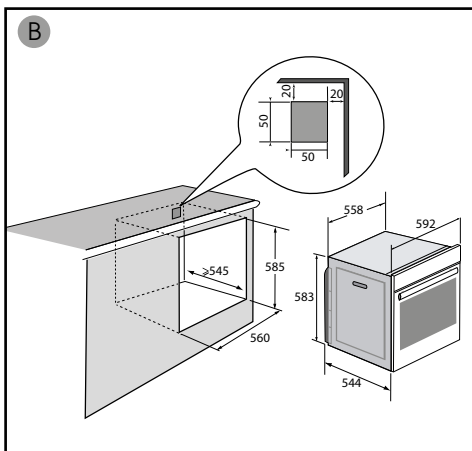
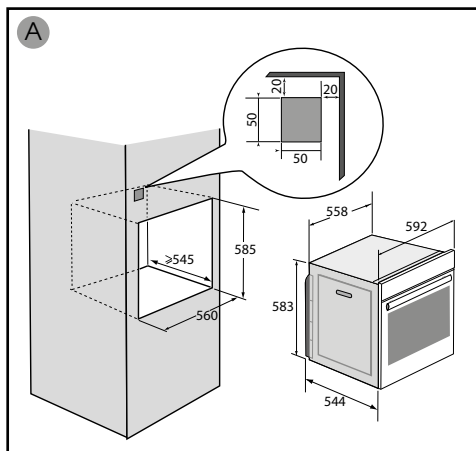



ΗΛΕΚΤΡΙΚΗ ΣΥΝΔΕΣΗ

Ο φούρνος πρέπει να συνδεθεί με ένα τυπικό καλώδιο τροφοδοσίας με 3 αγωγούς 1,5 mm² (1 ρη + 1 Ν + earth) που πρέπει να συνδεθεί στο δίκτυο 220 ~ 240 Volts μέσω μιας πρίζας. Πρότυπο IEC 60083 ή μια παντοπολική συσκευή αποσύνδεσης σύμφωνα με τους κανόνες εγκατάστασης.



Προειδοποίηση

Το καλώδιο προστασίας (πράσινο-κίτρινο) συνδέεται στον ακροδέκτη της συσκευής και πρέπει να συνδεθεί στη γείωση της εγκατάστασης. Η ασφάλεια εγκατάστασης πρέπει να είναι 16 αμπέρ.

Δεν μπορούμε να θεωρηθούμε υπεύθυνοι σε περίπτωση ατυχήματος ή συμβάντος που προκύπτει από ανύπαρκτη, ελαττωματική ή εσφαλμένη γείωση ή σε περίπτωση ακατάλληλης σύνδεσης.

• Πριν από την πρώτη χρήση

Πριν χρησιμοποιήσετε το φούρνο σας για πρώτη φορά, θερμάνετε τον άδειο, με την πόρτα κλειστή, για περίπου 15 λεπτά στην υψηλότερη θερμοκρασία, για να σπάσει η συσκευή. Το ορυκτό μαλλί που περιβάλλει την κοιλότητα του φούρνου μπορεί αρχικά να εκπέμψει μια συγκεκριμένη οσμή λόγω της σύνθεσής του. Ομοίως, μπορεί να παρατηρήσετε καπνό. Όλα αυτά είναι φυσιολογικά.

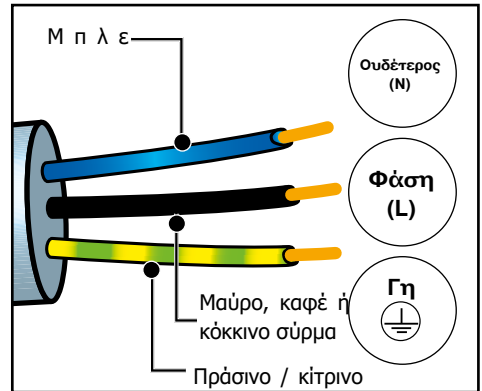



Παρουσίαση του φούρνου

ΠΑΡΟΥΣΙΑΣΗ ΤΟΥ ΦΟΥΡΝΟΥ

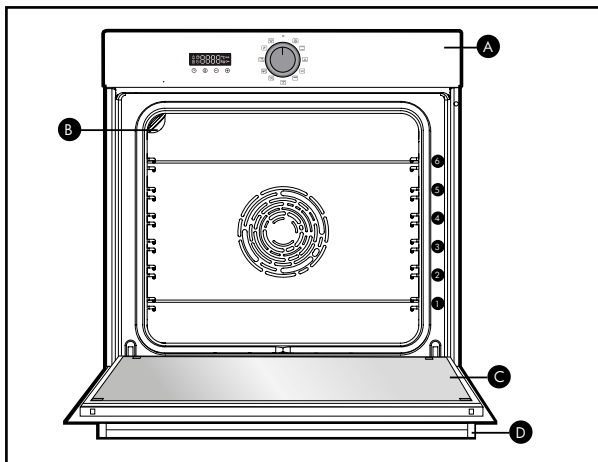

- A** Πίνακας ελέγχου
- B** Φωτισμός
- C** Πόρτα
- D** Λαβή

Αυτός ο φούρνος έχει 6 θέσεις για τα εξαρτήματα: ράγες στήριξης 1 έως 6.

• Οθονη ενδειξεων



- Διάρκεια μαγειρέματος
- Τέλος μαγειρέματος
- Κλείδωμα πλήκτρων
- Χρονοδιακόπτης
- Ένδειξη θερμοκρασίας
- Ένδειξη προθέρμανσης
- Κλείδωμα πόρτας

• Πληκτρα

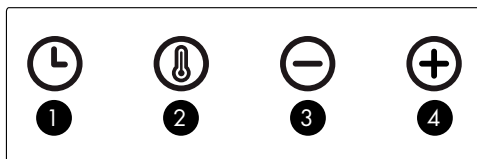

- 1** Ρύθμιση της ώρας και της διάρκειας
- 2** Ρύθμιση της θερμοκρασίας
- 3** Μείωση των τιμών
- 4** Αύξηση των τιμών



ΕΞΑΡΤΗΜΑΤΑ

• Σχάρα ασφαλείας για σταθεροποίηση

Η σχάρα μπορεί να χρησιμοποιηθεί για όλα τα ταψιά και τις φόρμες που περιέχουν τρόφιμα για μαγείρεμα ή γκρατινάρισμα. Χρησιμοποιείται για τα ψητά (μπορείτε να τα τοποθετείτε απευθείας πάνω στη σχάρα).

Τοποθετήστε τη λαβή σταθεροποίησης προς το

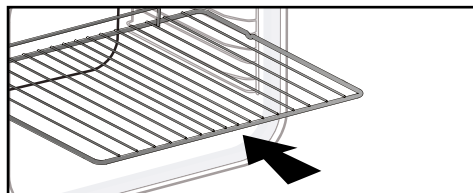

• Ταψί πολλαπλών χρήσεων, ταψί συλλογής ζωμών 45 mm

Τοποθετείται μέσα στις ράγες στήριξης, κάτω από τη σχάρα, με τη λαβή στραμμένη προς την πόρτα του φούρνου. Συλλέγει τους ζωμούς και τα λίπη από τα ψητά. Μπορείτε επίσης να το γεμίζετε με νερό μέχρι τη μέση για μαγείρεμα σε μπεν μαρί.

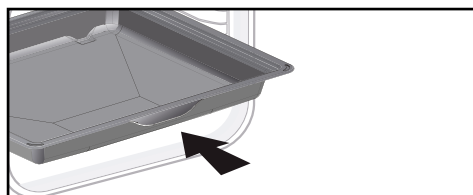

• Ταψί ζαχαροπλαστικής, 20 mm

Τοποθετείται μέσα στις ράγες στήριξης, με τη λαβή στραμμένη προς την πόρτα του φούρνου. Ιδανικό για να ψήνετε μπισκότα, σαμπλέ, καπκέικ. Η κλίση της επιφάνειάς του σας επιτρέπει να τοποθετείτε εύκολα τα παρασκευάσματά σας σε πιατέλα. Μπορείτε επίσης να το τοποθετείτε μέσα στις ράγες στήριξης, κάτω από τη σχάρα, για να συλλέγει τους ζωμούς και τα λίπη από τα ψητά.

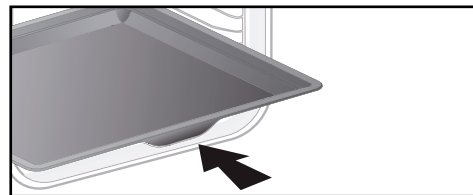

• Σύστημα συρόμενων ραγών

Χάρη στο νέο σύστημα συρόμενων ραγών, μπορείτε να χειρίζεστε τα τρόφιμα πανεύκολα, καθώς τα ταψιά αφαιρούνται ομαλά, απλοποιώντας σε μεγάλο βαθμό τον χειρισμό. Τα ταψιά μπορούν να αφαιρεθούν εντελώς, κάτι που επιτρέπει την πλήρη πρόσβαση. Επιπλέον, η σταθερότητά τους σας επιτρέπει να μαγειρεύετε και να χειρίζεστε τα τρόφιμα με απόλυτη ασφάλεια, μειώνοντας τον κίνδυνο εγκαυμάτων. Ως εκ τούτου, μπορείτε να βγάξετε τα τρόφιμα από τον φούρνο πολύ πιο εύκολα.

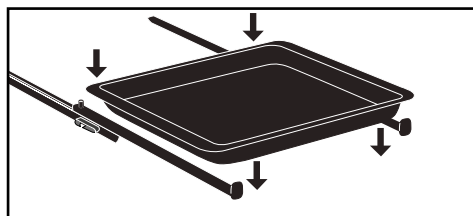

Προσοχή:

Αφαιρέστε τα αξεσουάρ και τα ράφια από το φούρνο πριν ξεκινήσετε τον καθαρισμό της πυρόλυσης.

Προσοχή:

Υπό την επίδραση της θερμότητας, τα αξεσουάρ μπορούν να παραμορφωθούν χωρίς να επηρεαστεί η λειτουργία τους. Επιστρέφουν στο αρχικό τους σχήμα όταν κρυώνονται.



ΕΓΚΑΤΑΣΤΑΣΗ ΚΑΙ ΑΦΑΙΡΕΣΗ ΤΩΝ ΣΥΡΟΜΕΝΩΝ ΡΑΓΩΝ

Αφού αφαιρέσετε τις 2 ράγες στήριξης τασιών, επιλέξτε το ύψος των ραγών στήριξης (από 2 έως 6) στο οποίο θέλετε να τοποθετήσετε τις συρόμενες ράγες. Τοποθετήστε τη δεξιά συρόμενη ράγα στη δεξιά ράγα στήριξης, ασκώντας αρκετή πίεση στο μπροστινό και στο πίσω μέρος της συρόμενης ράγας, ώστε οι 2 προεξοχές στο πλαίσι της συρόμενης ράγας να ασφαλισουν στη θέση τους, στη ράγα στήριξης τασιών. Ακολουθήστε την ίδια διαδικασία για την αριστερή συρόμενη ράγα.

ΣΗΜΕΙΩΣΗ: το συρόμενο τηλεσκοπικό μέρος της ράγας πρέπει να ξεδιπλώνεται προς το μπροστινό μέρος του φούρνου, ενώ το στοπ βρίσκεται απέναντί σας.

Για να αφαιρέσετε τις συρόμενες ράγες, αφαιρέσετε ξανά τις ράγες στήριξης τασιών.

Πιέστε προς τα κάτω ελαφρώς τις προεξοχές που υπάρχουν πάνω σε κάθε συρόμενη ράγα, για να τις αφαιρέσετε από τη ράγα στήριξης. Τραβήξτε τη συρόμενη ράγα προς το μέρος σας.

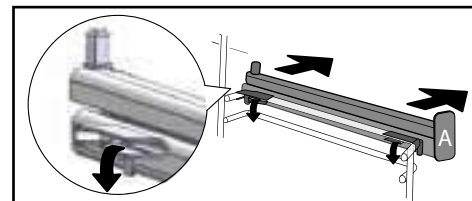
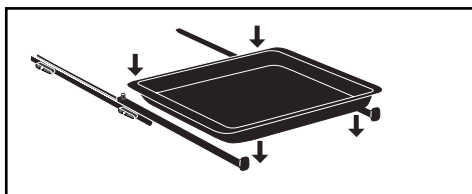
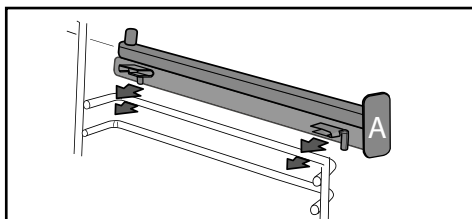

Συμβουλές:

Προκειμένου να αποφευχθεί η απελευθέρωση αναθυμιάσεων κατά το μαγείρεμα λιπαρών κρεάτων, σας συνιστούμε να προσθέσετε μια μικρή ποσότητα νερού ή λαδιού στο κάτω μέρος της κατσαρόλας.





Χρήση της συσκευής σας

ΡΥΘΜΙΣΕΙΣ

• Ρυθμιση της ωρας

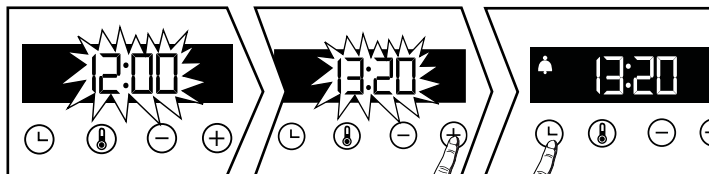
Όταν θέτετε τη συσκευή σε λειτουργία, στην οθόνη αναβοσβήνει η ένδειξη 12:00.





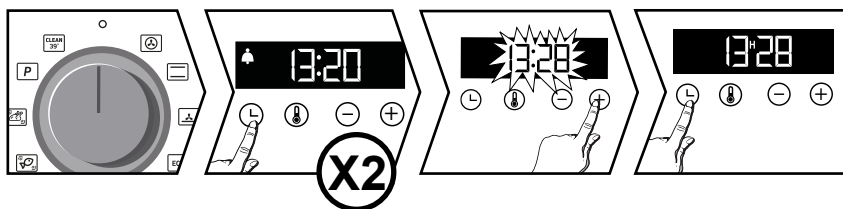

Ρυθμίστε την ώρα με τα πλήκτρα + ή -. Επιβεβαιώστε με το πλήκτρο . Σε περίπτωση διακοπής του ηλεκτρικού ρεύματος, η ώρα αναβοσβήνει.

• Τροποποίηση της ωρας

Ο διακόπτης επιλογής λειτουργίας πρέπει να βρίσκεται υποχρεωτικά στη θέση μηδέν.





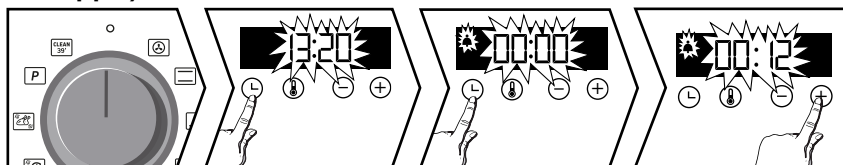

Πατήστε το πλήκτρο  θα εμφανιστεί το σύμβολο του χρονοδιακόπτη  εμφανίζεται ξανά πατήστε . Προσαρμόστε τη ρύθμιση ώρας με τα πλήκτρα + ή -. Validez avec la touche . Επιβεβαιώστε με το πλήκτρο .

• Χρονοδιακοπτης

Αυτή η λειτουργία μπορεί να χρησιμοποιηθεί μόνο όταν ο φούρνος βρίσκεται εκτός λειτουργίας.



Ο διακόπτης επιλογής λειτουργίας πρέπει να βρίσκεται υποχρεωτικά στη θέση μηδέν.

Πατήστε το πλήκτρο  το σύμβολο  το σύμβολο . Προσαρμόστε τη ρύθμιση ώρας με τα κουμπιά + ή -. Επιβεβαιώστε με το κλειδί .



ΣΗΜΕΙΩΣΗ: Μπορείτε να αλλάξετε ή να ακυρώσετε οποιαδήποτε στιγμή τον προγραμματισμό του χρονοδιακόπτη. Για ακύρωση, επιστρέψτε στο μενού του χρονοδιακόπτη και ρυθμίστε στην ένδειξη 00:00. Εάν δεν γίνει επιβεβαίωση, η αποθήκευση πραγματοποιείται αυτόματα σε λίγα δευτερόλεπτα.

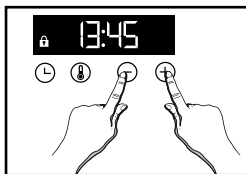

Χρήση της συσκευής σας

• ΚΛΕΙΔΩΜΑ ΠΛΗΚΤΡΩΝ





Πατήστε ταυτόχρονα τα πλήκτρα + και - έως ότου εμφανιστεί το σύμβολο  στην οθόνη. Για να ξεκλειδώσετε τα πλήκτρα, πατήστε ταυτόχρονα τα πλήκτρα + και - έως ότου το σύμβολο  εξαφανιστεί από την οθόνη.



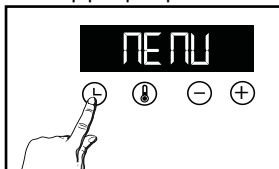

MENΟΥ

Μπορείτε να αλλάζετε διάφορες παραμέτρους του φούρνου σας. Για να το κάνετε αυτό:

Πατήστε το πλήκτρο  έως ότου εμφανιστεί η ένδειξη «**MENU**», για να προσπελάσετε τη λειτουργία ρυθμίσεων.



Πατήστε πάλι το πλήκτρο  προκειμένου να εμφανιστούν οι διάφορες ρυθμίσεις. Ενεργοποιήστε ή απενεργοποιήστε τις διάφορες παραμέτρους με τα πλήκτρα + και - βλ. παρακάτω πίνακα:

	ΑΥΤΟΜΑΤΑ: Στη λειτουργία μαγειρέματος, η λυχνία μέσα στο φούρνο απενεργοποιείται αυτόματα μετά από 90 δευτερόλεπτα. ΕΝΕΡΓΟΠΟΙΗΣΗ: Σε λειτουργία μαγειρέματος, η λυχνία είναι αναμμένη καθόλη τη διάρκεια.
	Ενεργοποίηση/ απενεργοποίηση του χαρακτηριστικού ήχου των κουμπιών
	Ενεργοποίηση/ απενεργοποίηση της λειτουργίας ενίσχυσης
	Ενεργοποίηση/ απενεργοποίηση της ρύθμισης επιδείξης

Για έξοδο από το "MENU" πατήστε ξανά .



Χρήση της συσκευής σας

ΛΕΙΤΟΥΡΓΙΕΣ ΨΗΣΙΜΑΤΟΣ

Χειροκίνητες λειτουργίες:



ΑΕΡΑΣ*

Ελάχιστη θερμοκρασία 35°C, μέγιστη 250°C
Συνιστάται για τη διατήρηση της υγρασίας του λευκού κρέατος, των ψαριών και των λαχανικών. Για ψήσιμο πολλών φαγητών ταυτόχρονα σε έως και τρία επίπεδα.



ΠΑΝΩ-ΚΑΤΩ ΑΝΤΙΣΤΑΣΗ

Ελάχιστη θερμοκρασία 35°C, μέγιστη 275°C
Συνιστάται για αργό και ήπιο μαγείρεμα: κυνήγι, κ.λπ. Για τη διατήρηση των χυμών στο κόκκινο ψητό κρέας. Για αργό ψήσιμο σε σκεπασμένη κατσαρόλα, φαγητά που ξεκινήσατε στην κατσαρόλα (κόκορα κρασάτο, κρέας κατσαρόλας).



ΚΑΤΩ ΑΝΤΙΣΤΑΣΗ ΚΑΙ ΑΕΡΑΣ

Ελάχιστη θερμοκρασία 75°C, μέγιστη 250°C
Συνιστάται για φαγητά με υγρασία (κις, τάρτες με ζουμερά φρούτα, κ.λπ.). Η ζύμη θα έχει ψηθεί πλήρως στο κάτω μέρος. Συνιστάται για συνταγές που φουσκώνουν (κέικ, μπριός, kügelhorr, κ.λπ.) και για σουφλέ που δεν θα σταματήσουν από την κρούστα που σχηματίζεται στην επιφάνεια.



ECO*

Ελάχιστη θερμοκρασία 35°C, μέγιστη 275°C
Αυτή η ρύθμιση εξοικονομεί ενέργεια, ενώ διατηρεί την ποιότητα του μαγειρέματος. Όλοι οι τύποι μαγειρέματος γίνονται χωρίς προθέρμανση.



ΔΥΝΑΤΟ ΓΚΡΙΑ

ΤΕΛεία θερμοκρασία 180°C, μέγιστη 275°C
Συνιστάται για ξεροψήσιμο, γκρατινέ πιάτα, για «κάψιμο» κρεμ μπρουλέ, κ.λπ.



ΓΚΡΙΑ ΚΑΙ ΑΕΡΑΣ

Ελάχιστη θερμοκρασία 180°C, μέγιστη 250°C
Τα ψητά κρέατα και τα πουλερικά γίνονται ζουμερά μέσα και τραγανά απ έξω.
Σύρετε το ταψί συλλογής υγρών στην κάτω ράγα στήριξης.
Συνιστάται για σουβλάκια πουλερικών ή κρέατος και για καλοψημένο μπουτί ή μπριζόλες βοδινού. Για να διατηρείται η υγρασία σε φιλέτα ψαριού.

Αυτόματες λειτουργίες:

Η Brandt σας προτείνει 3 νέες λειτουργίες που συνδυάζουν αυτόματα δυο τρόπους μαγειρέματος: το κλασικό μαγείρεμα και το μαγείρεμα στον ατμό, προκειμένου να διατηρούνται τα θρεπτικά στοιχεία των τροφίμων και να επιταχύνεται το μαγείρεμα.



ΛΕΥΚΑ ΚΡΕΑΤΑ

Συνιστάται προκειμένου το ψητό χοιρινό και το μοσχάρι να διατηρούνται μαλακά και να λιώνουν στο στόμα.



ΨΑΡΙΑ

Συνιστάται για να μαγειρευτείτε τα ψάρια ολόκληρα ή σε φιλέτο.



ΠΟΥΛΕΡΙΚΑ

Συνιστάται για το μαγείρεμα κοτόπουλου, γαλοπούλας, φραγκόκοτας και πάπιας.

Για να χρησιμοποιήσετε αυτές 3 λειτουργίες, θα πρέπει να τοποθετήσετε αρκετή ποσότητα χλιαρού νερού στο ταψί (ταψί συλλογής ζωμών) και να το τοποθετήσετε μέσα στον φούρνο στην κάτω ράγα στήριξης και το φαγητό που θέλετε να μαγειρέψετε στη ράγα στήριξης του 3ου επιπέδου.

Όσον αφορά την ποσότητα νερού που πρέπει να τοποθετήσετε στο ταψί συλλογής ζωμών, ανατρέξτε στον πίνακα αυτόματων συνδυαστικών λειτουργιών με χρήση ατμού που υπάρχει στο τέλος του χειριδίου.



ΛΕΙΤΟΥΡΓΙΑ SMART ASSIST.

Ο φούρνος σας διαθέτει τη λειτουργία «SMART ASSIST», η οποία, κατά τον προγραμματισμό, προτείνει έναν χρόνο μαγειρέματος με δυνατότητα τροποποίησης, ανάλογα με τη λειτουργία μαγειρέματος που έχετε επιλέξει.

**Η λειτουργία μαγειρέματος βάσει του προτύπου EN 60350-1: 2016 δηλώνει τη συμμόρφωση με τις απαιτήσεις της ετικέτας κατανάλωσης ενέργειας του ευρωπαϊκού κανονισμού EE/65/2014.*



ΑΜΕΣΟ ΜΑΓΕΙΡΕΜΑ

• Ξεκινώντας το άμεσο μαγείρεμα

Ο προγραμματιστής πρέπει να εμφανίζει μόνο την ώρα. Αυτό δεν πρέπει να αναβοσβήνει. Γυρίστε τον επιλογέα λειτουργιών στη θέση της επιλογής σας.

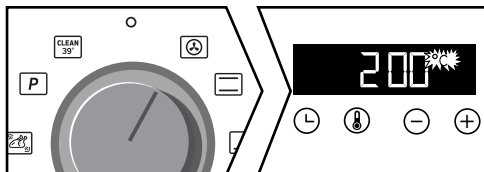

Για τις μη αυτόματες λειτουργίες:

Η αύξηση της θερμοκρασίας ξεκινά αμέσως. Ο φούρνος προτείνει μια θερμοκρασία, την οποία μπορείτε να αλλάξετε. Ο φούρνος θερμαίνεται και η ένδειξη θερμοκρασίας αναβοσβήνει. Μια σειρά χαρακτηριστικών ήχων ακούγεται όταν ο φούρνος φτάσει στη θερμοκρασία που έχει οριστεί.

Για τις αυτόματες λειτουργίες:

Στην οθόνη εμφανίζεται το

Επιλέξτε το είδος του τροφίμου που θέλετε χρησιμοποιώντας τον πίνακα που θα βρείτε στο τέλος του εγχειριδίου. Πατήστε τα πλήκτρα + και - έως ότου εμφανιστεί το επιθυμητό σύμβολο στην οθόνη και, στη συνέχεια, επιβεβαιώστε με το πλήκτρο

Θα εμφανιστεί το βάρος που θα αναβοσβήνει. Υποδείξτε το πραγματικό βάρος του τροφίμου, χρησιμοποιώντας τα πλήκτρα + και -, και, στη συνέχεια, επιβεβαιώστε

Δεν χρειάζεται να πραγματοποιήσετε καμία άλλη ρύθμιση, καθώς η θερμοκρασία και ο χρόνος μαγειρέματος υπολογίζονται αυτόματα. Ο χρόνος τερματισμού του μαγειρέματος αναβοσβήνει.

• Τροποποίηση της θερμοκρασίας

Πατήστε το πλήκτρο

Προσαρμόστε τη θερμοκρασία με τα πλήκτρα + ή -. Επιβεβαιώστε πατώντας

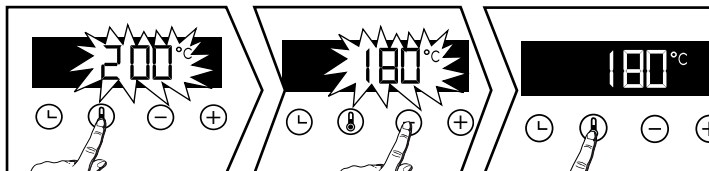

• Προγραμματισμός της διάρκειας

Προβείτε σε άμεσο μαγείρεμα και, στη συνέχεια, πατήστε . Η διάρκεια μαγειρέματος αναβοσβήνει, υποδεικνύοντας ότι μπορεί να πραγματοποιηθεί η ρύθμιση. Πατήστε + ή - για να ρυθμίσετε τη διάρκεια μαγειρέματος.

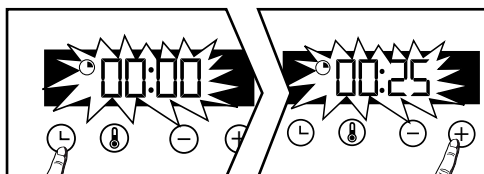



ΛΕΙΤΟΥΡΓΙΑ SMART ASSIST.

Ο φούρνος σας διαθέτει τη λειτουργία «SMART ASSIST», η οποία, κατά τον προγραμματισμό, προτείνει έναν χρόνο μαγειρέματος με δυνατότητα τροποποίησης, ανάλογα με τη λειτουργία μαγειρέματος που έχετε επιλέξει. Δείτε τον παρακάτω πίνακα.

Η αντίστροφη μέτρηση ξεκινά αμέσως μόλις επιτευχθεί η θερμοκρασία μαγειρέματος.

ΛΕΙΤΟΥΡΓΙΑ ΜΑΓΕΙΡΕΜΑΤΟΣ	ΣΥΝΙΣΤΩΜΕΝΟΣ ΧΡΟΝΟΣ ΜΑΓΕΙΡΕΜΑΤΟΣ
	30 λεπτά
	30 λεπτά
	30 λεπτά
	30 λεπτά
	7 λεπτά
	15 λεπτά

• Μαγειρεμα με καθυστερημενη εναρξη

Προχωρείτε όπως στην περίπτωση προγραμματισμένης διάρκειας. Μετά τη ρύθμιση ⌚ διάρκειας μαγειρέματος, πατήστε το πλήκτρο ⏸.

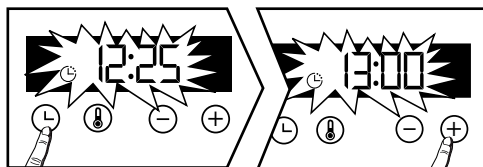

Η ένδειξη αναβοσβήνει. Ρυθμίστε την ώρα τερματισμού μαγειρέματος με τα πλήκτρα + ή -.

Η αποθήκευση της ώρας τερματισμού του μαγειρέματος πραγματοποιείται αυτόματα σε μερικά δευτερόλεπτα. Η ένδειξη τερματισμού μαγειρέματος σταματά να αναβοσβήνει.



ΚΑΘΑΡΙΣΜΟΣ ΤΗΣ ΕΞΩΤΕΡΙΚΗΣ ΕΠΙΦΑΝΕΙΑΣ

• Καθαρισμος του εσωτερικου του φουρνου





Προσοχή

Αφαιρέστε τα εξαρτήματα και τις ράγες στήριξης του φούρνου πριν προβείτε στον καθαρισμό με πυρόλυση. Πριν προβείτε στον καθαρισμό του φούρνου σας με πυρόλυση, αφαιρέστε τους πιο έντονους λεκέδες, αν υπάρχουν. Αφαιρέστε τα υπολείμματα λίπους από την πόρτα με ένα υγρό σφουγγάρι.

Για λόγους ασφαλείας, ο καθαρισμός με πυρόλυση πρέπει να εκτελείται μόνον αφού ασφαλίσει αυτόματα η πόρτα, ώστε να είναι αδύνατον να ξεκλειδώσει.

• Άμεσος αυτοκαθαρισμός

Το χρονόμετρο πρέπει να εμφανίζει την ώρα, χωρίς να αναβοσβήνει. Επιλέξτε έναν από τους κύκλους αυτοκαθαρισμού χρησιμοποιώντας τον διακόπτη λειτουργιών  ή  :

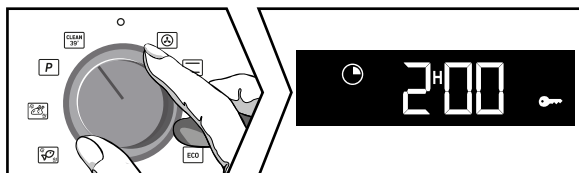



= Καθαρισμός σε 39 λεπτά

- Στο τέλος κάθε μαγειρέματος εμφανίζεται στην οθόνη η ένδειξη «Clean 39», που σας προτείνει να ξεκινήσετε τον συγκεκριμένο καθαρισμό. Γυρίστε τον διακόπτη σε αυτή τη λειτουργία και επιβεβαιώστε πατώντας το πλήκτρο . Εμφανίζεται στην οθόνη η διάρκεια 0:39 μαζί με την ένδειξη «Clean 39», και ξεκινά ο καθαρισμός. Μετά από μερικά λεπτά, εμφανίζεται ένα κλειδί και η πόρτα του φούρνου κλειδώνει αυτόματα καθ' όλη τη διάρκεια του προγράμματος για λόγους ασφαλείας.

Εάν θέλετε να χρησιμοποιήσετε το πρόγραμμα «Clean 39» σε κρύο ή σε όχι αρκετά ζεστό φούρνο, οι προϋποθέσεις εκκίνησης του προγράμματος δεν επιτρέπουν αυτόν τον καθαρισμό. Στην οθόνη εμφανίζεται η ένδειξη 0:00 και θα πρέπει να επιλέξετε ένα άλλο πρόγραμμα αυτοκαθαρισμού .



 = **Πυρόλυση σε 2 ώρες ή**. Γυρίστε τον διακόπτη σε αυτή τη λειτουργία.

Γυρίστε τον διακόπτη σε αυτή τη λειτουργία. Στην οθόνη εμφανίζεται το . Πατήστε το + για να επιλέξετε την πυρόλυση που θέλετε, ανάλογα με τον βαθμό λερώματος του φούρνου σας.

Ανάλογα με την επιλογή σας, εμφανίζεται η διάρκεια 2:00. Επιβεβαιώστε με το πλήκτρο . Το  εμφανίζεται στην οθόνη και ξεκινά η πυρόλυση.

Στο τέλος του καθαρισμού, η ένδειξη στην οθόνη θα είναι 0:00 και η πόρτα θα ξεκλειδώσει. Επαναφέρετε το διακόπτη επιλογής λειτουργιών στη θέση 0.

• Αναβολή της πυρόλυσης

Έχετε δυνατότητα επιλογής αναβολής της έναρξης της πυρόλυσης. Αφού εμφανιστεί η διάρκεια του προγράμματος στην οθόνη, πατήστε το πλήκτρο  και ρυθμίστε τον νέο χρόνο τερματισμού χρησιμοποιώντας τα πλήκτρα + και - και, στη συνέχεια, επιβεβαιώστε με το . Ο αυτοκαθαρισμός θα ξεκινήσει αργότερα για να σταματήσει κατά τον νέο χρόνο που προγραμματίσατε. Γυρίστε πάλι τον επιλογέα λειτουργίας στο 0 μόλις ολοκληρωθεί ο καθαρισμός.



• Καθαρισμος της εξωτερικης επιφανειας

Χρησιμοποιήστε ένα μαλακό πανί, μουσκεμένο με υγρό καθαρισμού για τα τζάμια. Μην χρησιμοποιείτε κρέμες καθαρισμού ή σκληρά σφουγγάρια.

• Καθαρισμός των συρμάτων

Αποσυναρμολογήστε τα καλώδια για να τα καθαρίσετε. Σηκώστε το μπροστινό μέρος του βήματος προς τα πάνω. σπρώξτε όλο το βήμα προς τα πάνω και αφήστε το μπροστινό άγκιστρο από το περιβλημά του. Στη συνέχεια, τραβήξτε ελαφρά ολόκληρο το βήμα προς εσάς για να απελευθερώσετε τα πίσω άγκιστρα από το περίβλημά τους. Αφαιρέστε τα 2 βήματα.

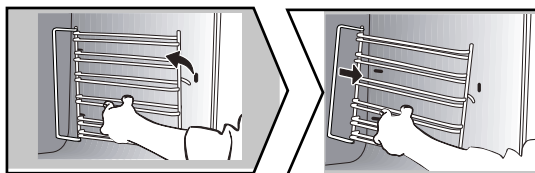

• Καθαρισμός του γυαλιού της πόρτας

! Προειδοποίηση:

Μην χρησιμοποιείτε καθαριστικά καθαρισμού, λειαντικά σφουγγάρια ή μεταλλικές ξύστρες για να καθαρίσετε τη γυάλινη πόρτα του φούρνου, η οποία μπορεί να γρατσουνίσει την επιφάνεια και να προκαλέσει θραύση του γυαλιού.

Αρχικά αφαιρέστε το υπερβολικό γράσο από τον εσωτερικό πίνακα με ένα μαλακό πανί και υγρό έκπλυσης. Για να καθαρίσετε τα διάφορα εσωτερικά τζάμια, προχωρήστε στην αποσυναρμολόγησή τους ως εξής:

• Καθαρισμός του γυαλιού της πόρτας

Ανοίξτε εντελώς την πόρτα και μπλοκάρτε τη χρησιμοποιώντας την πλαστική σφήνα που παρέχεται στην πλαστική θήκη της συσκευής σας.

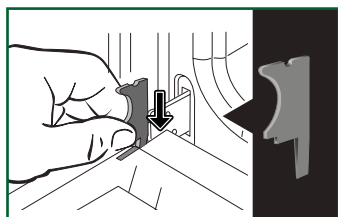

Αφαιρέστε το πρώτο περικομμένο παράθυρο: πατήστε χρησιμοποιώντας ένα εργαλείο (κατσαβίδι) στις θέσεις (A) για να ξεκουμπώσετε το παράθυρο και αφαιρέστε το.



Σπουδαίος:

Βεβαιωθείτε ότι έχετε επισημάνει την κατεύθυνση συναρμολόγησης αυτού του 1ου παραθύρου (λαμπερή πλευρά προς εσάς)



Καθαρισμός



Ανάλογα με το μοντέλο, η πόρτα αποτελείται από δύο πρόσθετα τζάμια με μαύρο ελαστικό διαχωριστικό σε κάθε γωνία. Εάν είναι απαραίτητο, αφαιρέστε τα για καθαρισμό.

Μην βυθίζετε τα παράθυρα σε νερό. Ξεπλύνετε με καθαρό νερό και στεγνώστε με ένα πανί χωρίς χνούδι.

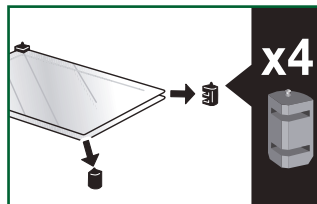
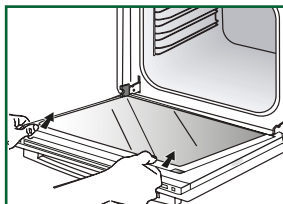
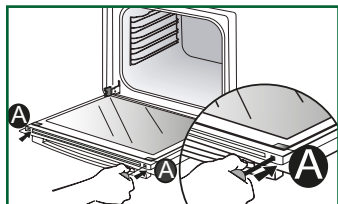

• Επανατοποθέτηση των παραθύρων της πόρτας

Μετά τον καθαρισμό, επανατοποθετήστε τις τέσσερις στάσεις λαστιχένιου βέλους προς τα πάνω και επανατοποθετήστε τη γυάλινη διάταξη.

Εμπλέξτε το τελευταίο τζάμι στα μεταλλικά στηρίγματα και μετά στερεώστε το, γυαλιστερή πλευρά προς το μέρος σας.

Η συσκευή σας λειτουργεί ξανά.

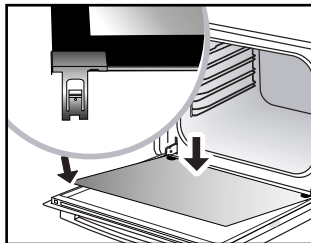
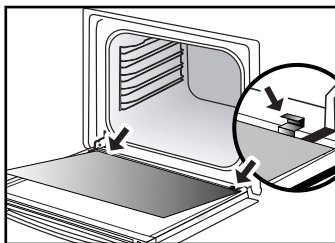
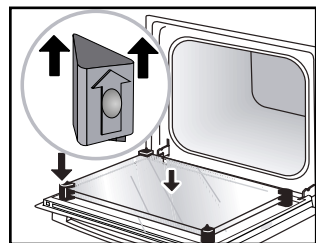

• Αντικατάσταση της λυχνίας του φούρνου



Προειδοποίηση:

Βεβαιωθείτε ότι η συσκευή είναι αποσυνδεδεμένη από την παροχή ηλεκτρικού ρεύματος, πριν να αντικαταστήσετε τη λυχνία προκειμένου να αποφύγετε τον κίνδυνο ηλεκτροπληξίας.

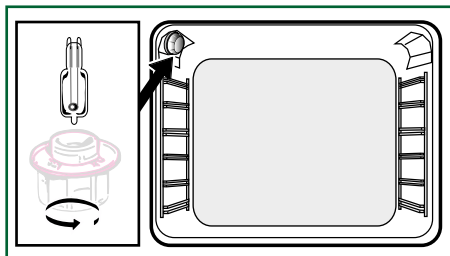

Προδιαγραφές λαμπτήρα:

25 W, 220-240 V~, 300°C, cap G9.

Για να ξεβιδώνετε το κάλυμμα της λυχνίας, χρησιμοποιείτε ένα γάντι από καουτσούκ, το οποίο θα διευκολύνει την αποσυναρμολόγηση.



Ανωμαλίες και λύσεις

ΑΝΩΜΑΛΙΕΣ ΚΑΙ ΛΥΣΕΙΣ

Ο φούρνος δεν θερμαίνεται.

Βεβαιωθείτε ότι ο φούρνος είναι σωστά συνδεδεμένος και ότι η ασφάλεια της εγκατάστασής σας λειτουργεί. Αυξήστε την επιλεγμένη θερμοκρασία.

Η λυχνία του φούρνου δεν λειτουργεί.

Επανατοποθετήστε τη λυχνία ή την ασφάλεια. Βεβαιωθείτε ότι ο φούρνος είναι σωστά συνδεδεμένος.

Ο ανεμιστήρας ψύξης συνεχίζει να λειτουργεί μετά τη διακοπή λειτουργίας του φούρνου.

Αυτό είναι φυσιολογικό. Ο ανεμιστήρας μπορεί να συνεχίσει να λειτουργεί, το πολύ για 1 ώρα μετά το μαγείρεμα για να μειωθεί η θερμοκρασία εντός και εκτός του φούρνου. Εάν ο ανεμιστήρας λειτουργεί για περισσότερο από μια ώρα, επικοινωνήστε με το τμήμα εξυπηρέτησης πελατών.

Ο κύκλος καθαρισμού με πυρόλυση δεν ξεκινά.

Ελέγξτε εάν η πόρτα είναι κλειδωμένη. Εάν υπάρχει σφάλμα κλειδώματος της πόρτας ή βλάβη στον αισθητήρα θερμοκρασίας, επικοινωνήστε με το Τμήμα Εξυπηρέτησης Πελατών.

Το σύμβολο αναβοσβήνει στην οθόνη.

Σε περίπτωση σφάλματος στο κλειδωμα της πόρτας, επικοινωνήστε με το Τμήμα Εξυπηρέτησης Πελατών.

Δόνηση θορύβου.

Βεβαιωθείτε ότι το καλώδιο τροφοδοσίας δεν είναι σε επαφή με τον πίσω τοίχο.

Αυτό δεν έχει καμία επίδραση στη σωστή λειτουργία της συσκευής σας, αλλά μπορεί ωστόσο να προκαλέσει δονήσιμο θόρυβο κατά τον αερισμό. Αφαιρέστε τη συσκευή σας και μετακινήστε το καλώδιο. Αντικαταστήστε το φούρνο σας.



Κλήσεις Σέρβις

ΚΛΗΣΕΙΣ ΣΕΡΒΙΣ

Οποιοσδήποτε επισκευές στη συσκευή σας πρέπει να εκτελούνται από έμπειρο επαγγελματία εξουσιοδοτημένο από την εταιρεία. Όταν τηλεφωνείτε, να παρέχετε τα πλήρη στοιχεία αναφοράς της συσκευής σας (εμπορικά στοιχεία αναφοράς, στοιχεία αναφοράς σέρβις, αριθμός σειράς), για να μπορούμε να διαχειριστούμε καλύτερα την κλήση σας. Αυτές οι πληροφορίες εμφανίζονται στην ετικέτα του κατασκευαστή που είναι τοποθετημένη στη συσκευή σας.

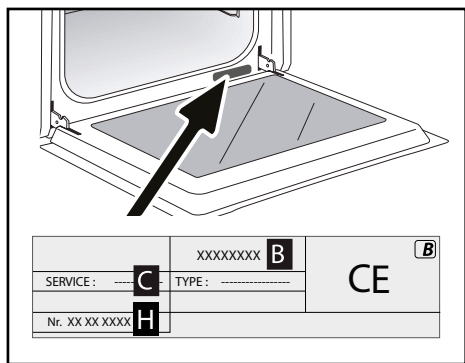

B: Εμπορικά στοιχεία αναφοράς
Γ: Στοιχεία αναφοράς σέρβις

H: Σειριακός αριθμός:

ΑΡΧΙΚΑ ΜΕΡΗ

Κατά τη διάρκεια μιας παρέμβασης, ζητήστε την αποκλειστική χρήση πιστοποιημένων γνήσιων ανταλλακτικών.





ΦΑΓΗΤΑ



επτά

Κρέας

Χοιρινό (1 kg)	200	2				180	2							60
Μοσχάρι (1 kg)	200	2				180	2							60-70
Ροσμίφι	240	2												30-40
Αρνί (μπούτι, ώμος, 2,5 kg)	220	1			220					200	2			60
Πουλερικά (1 kg)	200	2			220	180	2			210	3			60
Μεγάλα κομμάτια πουλερικών	180	1												60-90
Μπούτια κοτόπουλου					220		3			210	3			20-30
Παϊδάκια χοιρινά/μοσχαρίσια					210		3							20-30
Μοσχαρίσιες μπριζόλες (1 kg)					210		3			210	3			20-30
Αρνίσια παϊδάκια					210		3							20-30

Ψάρια

Ψάρι στο γκριλ					275	4								15-20
Ψητό ψάρι (τύπου σπάρος)	200	3					180	3						30-35
Ψάρι στη λαδόκολλα	220	3					200	3						15-20

Λαχανικά

Γκρατινέ (μαγειρεμένα τρόφιμα)					275	2								30
Πατάτα γκρατινέ	200	2					180	2						45
Λαζάνια	200	3					180	3						45
Γεμιστές ντομάτες	170	3					160	2						30

Αρτοσκευάσματα

Παντεσπάνι				180	2							180	2	35
Σφολιατσειδή	220	3										180	2	5-10
Ψωμάκια	180	1	210									180	2	35-45
Brownies	180	2					175	3						20-25
Κέικ - Ζουμερό κέικ (round cake)	180	1	180	1								180	2	45-50
Τάρτα	200	2					180	3						30-35
Ψημένες κρέμες	165	2										150	2	30-40

*Ανάλογα με το μοντέλο



ΦΑΓΗΤΑ											
	ΕΠΤΑ										
Αρτοσκευάσματα											
Μαντλέν	220	3					200	3			5-10
Ζύμη για σουδάκια	200	3					180	3		180	30-40
Μικρά ορεκτικά με σφολιάτα	220	3					200	3			5-10
Κέικ σαβαρέν	180	3								175	30-35
Τάρτα με λεπτή ζύμη	200	1					195	1			30-40
Τάρτα με ζύμη κουρού	215	1					200	1			20-25
Τάρτα με ζύμη με μαγιά	210	1					200	1			10-30
Άλλο											
Σουβλάκια	220	3			210	4					10-15
Τερίν	200	2					190	2			80-100
Πίτσα με λεπτή ζύμη	200	2									30-40
Πίτσα με αφράτη ζύμη											15-18
Κις											35-40
Σουφλέ										180	50
Πίτες	200	2									40-45
Ψωμί	220						200		220		30-40
Ψωμί	180				275	4-5					2-3
Μαγειρευτά (βραστά)	180	2								180	90-180

*Ανάλογα με το μοντέλο

⚠ Όλες οι θερμοκρασίες (°C) και οι χρόνοι μαγειρέματος δίνονται για προθερμασμένους φούρνους.

Σημείωση: Πριν τα βάλετε στο φούρνο, όλα τα κρεατικά πρέπει να παραμένουν τουλάχιστον για 1 ώρα σε θερμοκρασία δωματίου.

ΣΧΕΣΗ ΡΥΘΜΙΣΗΣ ΚΑΙ ΘΕΡΜΟΚΡΑΣΙΑΣ T °C

° Κελσίου	30	60	90	120	150	180	210	240	275
Ρύθμιση	1	2	3	4	5	6	7	8	9 maxi



Συνταγή με μαγιά (ανάλογα με το μοντέλο)

Συστατικά:

● Αλεύρι 2 kg ● Νερό 1240 ml ● Αλάτι 40 g ● 4 συσκευασίες ξηρή μαγιά
Ανακατέψτε τη ζύμη με ένα μίξερ και αφήστε την στο φούρνο να φουσκώσει.

Εκτέλεση: Για συνταγές ζύμης με μαγιά. Βάλτε τη ζύμη σε πυρίμαχο σκεύος. Αφαιρέστε τις ράγες στήριξης και τοποθετήστε το ταψί στο κάτω μέρος.

Προθερμάνετε το φούρνο στους 40—50°C βαθμούς με τη λειτουργία αέρα για πέντε λεπτά.

Σβήστε το φούρνο και αφήστε τη ζύμη να αυξηθεί σε όγκο για 25-30 λεπτά με την υπολειπόμενη θερμότητα.





ΔΟΚΙΜΕΣ ΑΠΟΔΟΣΗΣ ΣΥΜΦΩΝΑ ΜΕ ΤΟ ΠΡΟΤΥΠΟ CΕΙ 60350

ΕΙΔΟΣ ΤΡΟΦΙΜΟΥ	* ΤΡΟΠΟΣ ΨΗΣΙΜΑΤΟΣ	ΕΠΙΠΕΔΟ	ΕΞΑΡΤΗΜΑΤΑ	°C	ΔΙΑΡΚΕΙΑ Λεπ.	ΠΡΟΘΕΡΜΑΝΣΗ
Μπισκότα σαμπλέ (8.4.1)		5	ταψί 45 mm	150	30-40	ναι
Μπισκότα σαμπλέ (8.4.1)		5	ταψί 45 mm	150	25-35	ναι
Μπισκότα σαμπλέ (8.4.1)		2 + 5	ταψί 45 mm + σχάρα	150	25-45	ναι
Μπισκότα σαμπλέ (8.4.1)		3	ταψί 45 mm	175	25-35	ναι
Μπισκότα σαμπλέ (8.4.1)		2 + 5	ταψί 45 mm + σχάρα	160	30-40	ναι
Κεκάκια (8.4.2)		5	ταψί 45 mm	170	25-35	ναι
Κεκάκια (8.4.2)		5	ταψί 45 mm	170	25-35	ναι
Κεκάκια (8.4.2)		2 + 5	ταψί 45 mm + σχάρα	170	20-40	ναι
Κεκάκια (8.4.2)		3	ταψί 45 mm	170	25-35	ναι
Κεκάκια (8.4.2)		2 + 5	ταψί 45 mm + σχάρα	170	25-35	ναι
Αφράτο κέικ χωρίς λιπαρά (8.5.1)		4	σχάρα	150	30-40	ναι
Αφράτο κέικ χωρίς λιπαρά (8.5.1)		4	σχάρα	150	30-40	ναι
Αφράτο κέικ χωρίς λιπαρά (8.5.1)		2 + 5	ταψί 45 mm + σχάρα	150	30-40	ναι
Αφράτο κέικ χωρίς λιπαρά (8.5.1)		3	σχάρα	150	30-40	ναι
Αφράτο κέικ χωρίς λιπαρά (8.5.1)		2 + 5	ταψί 45 mm + σχάρα	150	30-40	ναι
Μηλόπιτα (8.5.2)		1	σχάρα	170	90-120	ναι
Μηλόπιτα (8.5.2)		1	σχάρα	170	90-120	ναι
Μηλόπιτα (8.5.2)		3	σχάρα	180	90-120	ναι
Γκρατιναρισμένη επιφάνεια (9.2.2)		5	σχάρα	275	3-6	ναι

* Ανάλογα με το μοντέλο

ΣΗΜΕΙΩΣΗ: Κατά τα ψησίματα σε 2 επίπεδα, μπορείτε να βγάξετε τα ταψιά από το φούρνο σε διαφορετικές στιγμές.



ΠΙΝΑΚΑΣ ΑΥΤΟΜΑΤΩΝ ΣΥΝΔΥΑΣΤΙΚΩΝ ΛΕΙΤΟΥΡΓΙΩΝ ΜΕ ΧΡΗΣΗ ΑΤΜΟΥ

Θέση διακόπτη	Ένδειξη στο χρονόμετρο	Τρόφιμα	Ποσότητα νερού που πρέπει να προστεθεί
		Κοτόπουλο	500 ml χλιαρό νερό μέσα στο ταψί συλλογής ζωμών
		Πάπια	500 ml χλιαρό νερό μέσα στο ταψί συλλογής ζωμών
		Γαλοπούλα	500 ml χλιαρό νερό μέσα στο ταψί συλλογής ζωμών
		Φραγκόκοτα	800 ml χλιαρό νερό μέσα στο ταψί συλλογής ζωμών
		Ολόκληρα ψάρια (μεγάλα)	500 ml χλιαρό νερό μέσα στο ταψί συλλογής ζωμών
		Ολόκληρα ψάρια (σε ταψί)	300 ml χλιαρό νερό μέσα στο ταψί συλλογής ζωμών
		Μικρά ψάρια ολόκληρα	300 ml χλιαρό νερό μέσα στο ταψί συλλογής ζωμών
		Φιλέτο ψαριού	300 ml χλιαρό νερό μέσα στο ταψί συλλογής ζωμών
		Ψητό χοιρινό	500 ml χλιαρό νερό μέσα στο ταψί συλλογής ζωμών
		Ψητό μοσχαράκι	500 ml χλιαρό νερό μέσα στο ταψί συλλογής ζωμών

ΠΡΟΣΟΧΗ

Να τοποθετείτε το ταψί συλλογής ζωμών (με το χλιαρό νερό) στην κάτω ράγα στήριξης, επίπεδο 1 και το φαγητό που θέλετε να μαγειρέψετε στη ράγα στήριξης του επιπέδου 3.



EN Informații pentru domeniul cavității (UE n° 6620/14)
DE Informationen zu Hohlraumkavitäten (UE n° 6620/14)
FR Informations concernant les foyers cavités (UE n° 6620/14)
ES Información sobre los hornos cavidades (UE n° 6620/14)
CS Informační údaje ke žebům pro cavitace (UE n° 6620/14)
IT Informazioni relative ai forni a cavità (UE n° 6620/14)
DA Oplysninger for ovns til huleindsugning (UE n° 6620/14)
NL Informatie met betrekking tot hohlraumkavitäten (UE n° 6620/14)
SV Tillämpningsytor för cavitace (UE n° 6620/14)
FI cavitaceen uunien tiedot (UE n° 6620/14)

EN	DE	FR	ES	CS	IT	DA	NL	SV	FI	Symbol	Value	Unit	EN	DE	FR	ES	CS	IT	DA	NL	SV	FI	
Type norme																							
Models identification																							
Type of oven																							
Mass of the appliance												kg											
Number of cavities																							
Heat source per cavity (type of fuel or gas)																							
Volume per cavity																							
Energy consumption (needed to heat a standardized load in electric mode per cycle in fan-forced cycle in conventional mode per cavity)																							
Energy consumption (needed to heat a standardized load in electric mode per cycle in fan-forced cycle in conventional mode per cavity)																							
Energy consumption (needed to heat a standardized load in electric mode per cavity)																							
Energy efficiency index per cavity																							

FR

CS

DA

DE

EL

EN

ES

FI

IT

NL

NO

PL

PT

SK

SV

Brandt



USER INSTRUCTIONS EN

OVEN

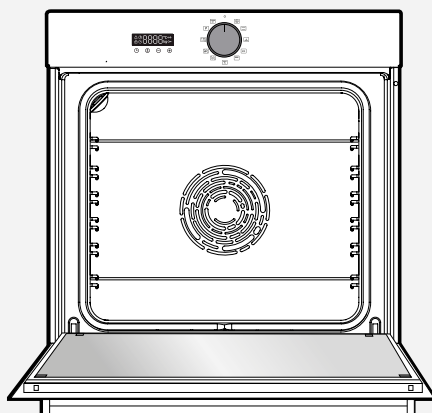

ORIGINE
FRANCE[®]
GARANTIE

BYCert.6011825

Dear Customer,

You have just acquired a **BRANDT** product and we would like to thank you.

We have designed and made this product with you, your lifestyle and your requirements in mind so that it meets your expectations. We have devoted our know-how, our innovative spirit and the passion that has been guiding us for over 60 years.

In an effort to ensure that our products meet your requirements in the best possible way, our Customer Relations department is at your disposal, to answer all your questions and to listen to all your suggestions.

Visit our website www.brandt.com where you will find our latest innovations, as well as useful and complementary information.

BRANDT is delighted to assist you every day and hopes you get the most out of your purchase.

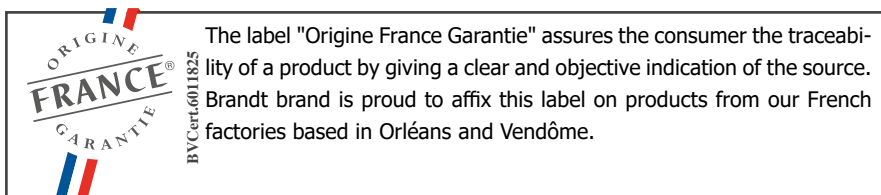

<https://brandt.com/>



Important: Before using your appliance, read this user guide carefully to familiarise yourself more quickly with its operation.



Table of Contents

SAFETY INSTRUCTIONS	4
ENVIRONMENT	6
Environment	6
Energy saving councils	6
INSTALLATION	7
Choice of location and fitting	7
Electrical connection.....	8
DESCRIPTION OF THE OVEN	9
Presentation of the oven	9
Display and buttons	9
Accessories.....	10
HOW TO USE YOUR APPLIANCE	12
Setting	12
Setting menu	12
Cooking mode.....	14
Starting cooking.....	15
CLEANING	17
Cleaning inside - outside	18
ANOMALIES AND SOLUTIONS	20
SERVICE CALLS	21
Service calls.....	21
COOKING AID	21
Cooking tables.....	22
Recipes with yeast	24
Performance testing.....	25
Automatic combined steam functions	26



IMPORTANT - READ CAREFULLY AND RETAIN FOR FUTURE USE.

This user guide is available for download on the brand's web-site.

When you receive the appliance, unpack it or have it unpacked immediately. Check its general appearance. Make a note of any reservations on the delivery slip and keep a copy.



Important:

This appliance may be used by children aged 8 years and older, and by persons with impaired physical sensorial or mental capacities, or without experience or knowledge, if they are supervised or have received prior instructions on how to use the appliance safely and have understood the risks involved. Children must not be allowed to play with the appliance. Cleaning and maintenance operations must not be carried out by children without supervision.

— Children must be supervised to prevent them from playing with the appliance.



WARNING:

— The appliance and its accessible parts become hot during use. Be

careful not to touch the heating elements inside the oven. Children under 8 years old must not be allowed near it unless they are supervised at all times.

— This appliance is designed to cook with the door closed.

— Before pyrolytic cleaning of your oven, remove all accessories and any thick deposits.

— During cleaning, the surfaces may become warmer than under normal conditions of use. It is advisable to keep children away from the appliance.

— Do not use a steam cleaner.

— Do not use abrasive cleaning products or hard metal scrapers for cleaning the oven's glass door, as they could scratch the surface and cause the glass to shatter.



WARNING :

Make sure the appliance is disconnected from the power before replacing the lamp in order to avoid the risk of electric shock. Change the lamp only when the appliance has cooled down. To unscrew the view port and the light, use a rubber glove, which will make disassembly easier.



The electrical plug must remain accessible after installation.

— It must be possible to disconnect the appliance from the power supply, either using a plug or by fitting a switch on the fixed wiring system in accordance with installation rules.

— If the power cable is damaged, it should be replaced by the manufacturer, its after-sales service department or by a similarly qualified person in order to avoid danger.

— This appliance may be installed either under a worktop or in a cabinet column, as indicated on the installation diagram.

— Centre the oven in the unit so as to ensure a minimum distance of 10 mm between the appliance and the surrounding unit. The material of the unit supporting the appliance must be heat-resistant (or covered with a heat-resistant material). For greater stability, attach the oven to the unit with 2 screws through the holes provided on the side panels.

— In order to avoid overheating, the appliance must not be installed behind a decorative door..

— This appliance is designed to be used for domestic and similar

applications such as:

Kitchen areas for the staff of shops, offices and other professional premises; Farms; Use by clients of hotels, motels and other residential type establishments; guest house type environments.

— The oven must be turned off when cleaning inside the oven.

Do not modify the characteristics of this appliance; doing so could be dangerous.

Do not use your oven as a larder or to store any items after use.



CARE FOR THE ENVIRONMENT

- This appliance's packing materials are recyclable. Please recycle them and help protect the environment by depositing them in municipal containers provided for this purpose.

- Your appliance also contains many recyclable materials. It is therefore marked with this logo to indicate that used appliances must not be mixed with other waste.

The appliance recycling organised by your manufacturer will therefore be conducted in optimum conditions, in accordance with European directive 2002/96/EC on electrical and electronic equipment waste.

Consult your local authority or your retailer to locate your nearest used appliance drop-off points.

- We thank you for your help in protecting the environment.

ENERGY SAVING COUNCIL

Keep the oven door closed during baking.



CHOICE OF LOCATION AND FITTING

The diagrams show the dimensions of a cabinet that will be able to hold your oven.

This appliance may be installed either under a worktop (A) or in a column (B). If the cabinet is open, its opening at the back must be 70 mm maximum.

Install the oven in the furniture. To do this, remove the rubber stops and pre-drill a 2-mm diameter hole in the wall of the furniture to avoid splitting the wood. Attach the oven with the two screws. Re-position the rubber stops.



Tip

To be certain that you have properly installed your appliance, do not hesitate to call on a household appliance specialist.



Warning :

If the electrical installation in your residence requires any changes in order to hook up your appliance, contact a professional electrician. If the oven malfunctions in any way, unplug the appliance or remove the fuse corresponding to the sector where the oven is hooked up.

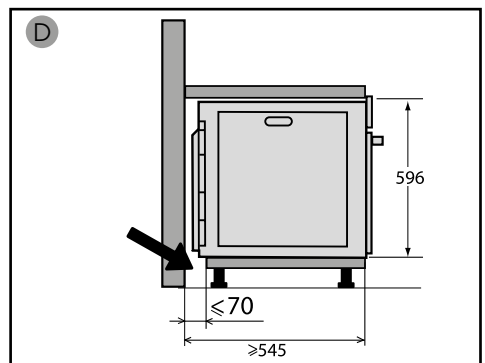
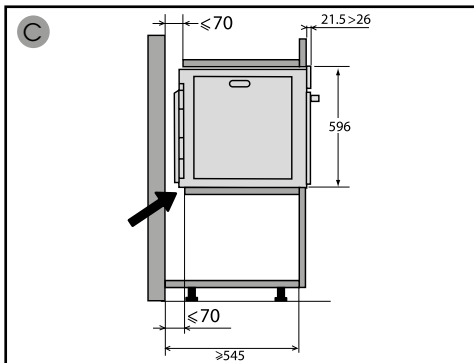
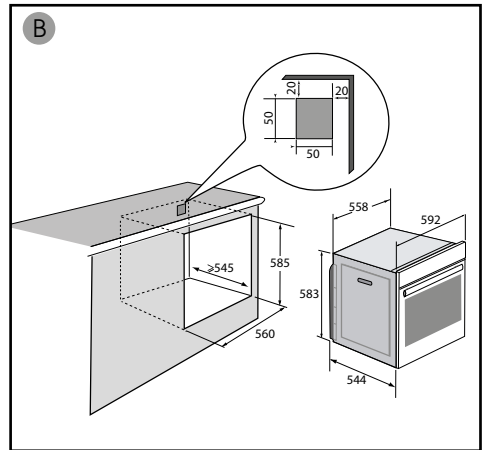
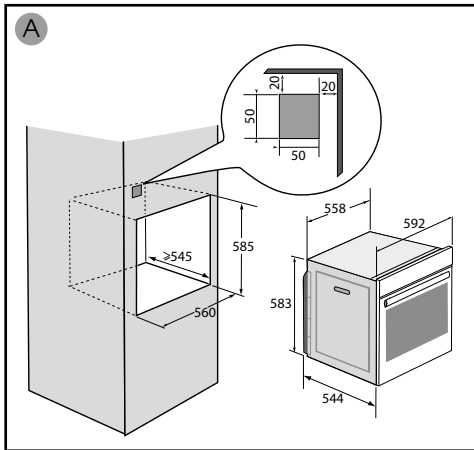



ELECTRICAL CONNECTION

Your oven must be connected with a (standard) power cable with 3 conductors of 1.5mm² (1 live + 1 neutral + earth) which must be connected to a 220-240V_~ single-phase grid by means of a 1 live + 1 neutral + earth CEI 60083 standard power socket or via an all-poles cut-off device in compliance with the installation rules.

Warning

The safety wire (green-yellow) is connected to the appliance's  terminal and must be connected to the earth terminal of the electrical set-up.

The fuse in your set-up must be 16 amperes.

We cannot be held responsible for any accident resulting from inexistent, defective or incorrect earthing.

• **Prior to first use**

Before using your oven for the first time, heat it with the door closed for about 15 minutes on the highest temperature. to break in the appliance. The mineral wool surrounding the oven cavity may initially give off a particular odour due to its composition. You may also notice smoke development. This is normal.

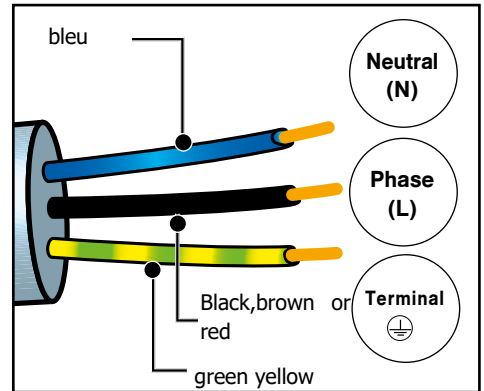



Description of the oven

PRESENTATION OF THE OVEN

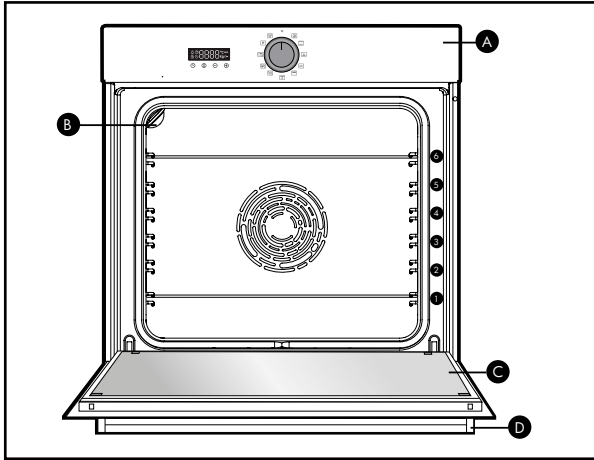

- A** Control panel
- B** Light
- C** Door
- D** Handle

This oven has 6 positions for the accessories: shelf supports 1 to 6.

DISPLAY AND BUTTONS

• Display



- Cooking time
- End of cooking
- Keypad lock
- Timer
- Temperature indicator
- Pre-heating indicator
- Door lock

• Buttons

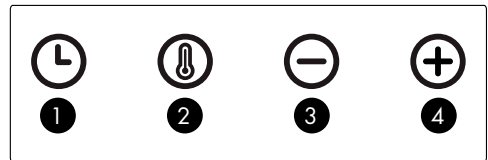

- 1** Set clock and cooking time
- 2** Set temperature
- 3** - button
- 4** + button



ACCESSORIES

• Anti-tip safety grid

The grid can be used to hold all dishes and moulds containing foodstuffs to be cooked or browned. It can be used for barbecues (to be placed directly on the grid).

Insert the anti-tip safety grid towards the back of the oven.

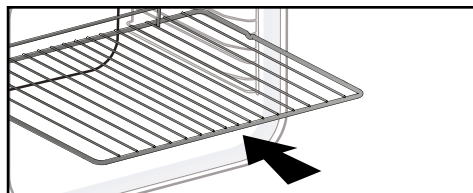

• Multi-purpose 45mm drip pan

When inserted in the supports under the grid with the handle towards the oven door, it collects juice and fat from grilling, and can be used half-filled with water as a double-boiler.

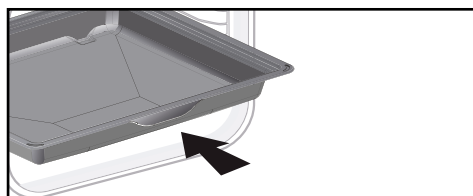

• 20mm pastry dish

When inserted in the supports with the handle towards the oven door, it is ideal for baking cookies, shortbread and cupcakes. Its tilted surface makes it practical and easy to use. Can also be inserted into the supports under the grid to collect juice and fat from grilling.

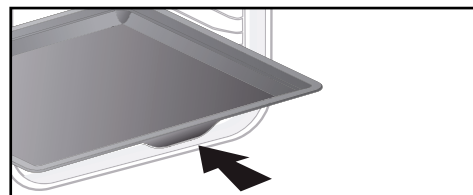

• Sliding rail system

The new sliding rail system makes food more practical and easier to handle as the trays can be effortlessly pulled for simpler handling. The trays can be completely removed, providing full access. Their stability ensures that food can be handled safely, reducing the risk of burns. This means that you can take food out of the oven far more easily.

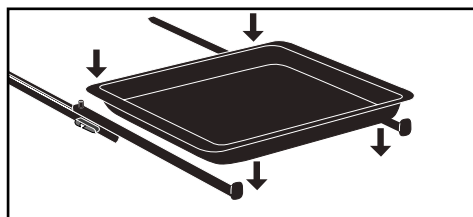

Warning :

Remove the accessories and supports from the oven before beginning pyrolysis cleaning.

Warning :

Under the effect of heat, the accessories may become deformed without affecting their function. They will return to their original shape when cooled.



INSTALLING AND REMOVING THE SLIDING RAILS

After removing the 2 shelf runners, choose the height (2 to 5) at which you want to fit your rails. Snap the left rail against the left shelf runner by applying enough pressure to the front and back of the rail so that the 2 tabs on the side of the rail slot into the shelf runner. Do the same for the right-handrail.

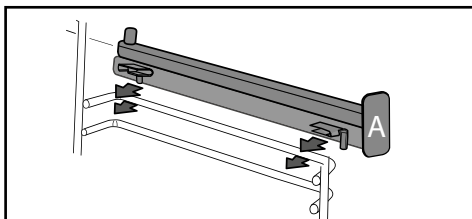

NOTE: the telescopic sliding part of the rail must unfold towards the front of the oven, with the buffer **A** opposite you.

Insert your 2 shelf runners and then put your tray on the 2 rails. The system is now ready to use.

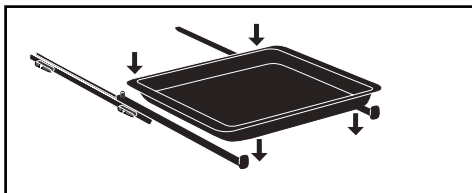

To remove the rails, remove the shelf runners again. Slightly prise apart the bottom of the tabs fixed on each rail to release

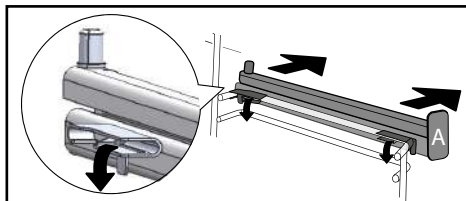

Tip

To avoid fumes when cooking fatty meats, we recommend you add a small amount of water or oil to the bottom of the drip pan.



How to use your appliance

SETTING

• Setting the clock

When switching on the display flashes at 12:00.

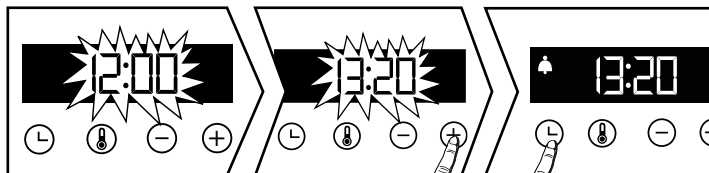

When switching on the display flashes at 12:00. Set the clock with + or -. Confirm with . If there is a power cut, the clock flashes

• Changing the clock

The function selector switch must be in the 0 position.

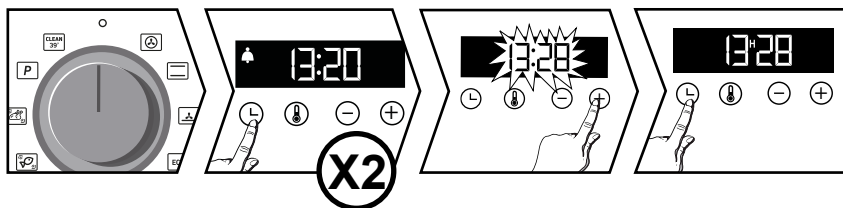

Press . The symbol appears. Press again adjust the clock setting with + or -. Confirm with . The cooking end time is automatically saved after a few seconds.

• Timer

This function can only be used when the oven is switched off.

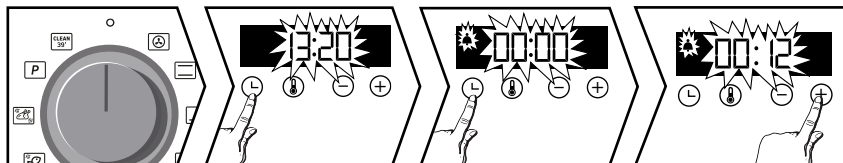

Press . The timer flashes. Set the timer with + or -. Press to confirm. The timer will then start. Once the time has lapsed, there is a sound signal. To stop it, press any key. The time appears again in the display.



NB: You can modify or cancel the timer at any time. To cancel, go back to the timer menu and set to 00:00. Without having to confirm, the adjustment is automatically saved after a few seconds.

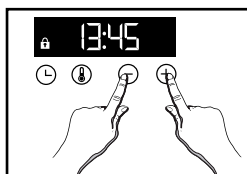

How to use your appliance

• Keypad locking





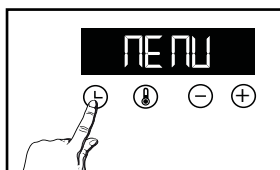

Press + and - at the same time until the  symbol appears on the screen. To unlock the keypad, press + and - together until the  symbol disappears off the screen.

SETTING

You can adjust different settings on your oven. To do so: Press  until you get to the "MENU" display to access the settings mode.



Press  again to scroll through the different settings. Activate or de-activate the different parameters with + and -; see table below:

	AUTO: In cooking mode , the light inside the oven automatically turns itself off after 90 seconds. ON: In cooking mode , the light is on all the time.
	Activate/de-activate the beeping sound of the buttons
	Activate/de-activate pre-heating mode
	Activate/de-activate demonstration mode

To exit the "MENU", press .



How to use your appliance

COOKING MODES

MANUAL FUNCTIONS :



CIRCULATING HEAT*

Min temperature 35°C, max 250°C

Recommended for keeping white meat, fish and vegetables moist. For cooking multiple items on up to three levels.



TRADITIONAL

Min temperature 35°C, max 275°C

Recommended for slow, gentle cooking: rich game, etc. For retaining the juices in red meat roasts. For simmering in a covered casserole, dishes that were begun on the hob (coq au vin, stew).



PULSED BOTTOM

(Min temperature 75°C, max 250°C)

Recommended for moist dishes (quiches, tarts with juicy fruits, etc.). The pastry will be thoroughly cooked on the bottom. Recommended for recipes which rise (cake, brioche, kügelhopf, etc.) and for soufflés which will not be stopped by a crust on the top.



ECO*

Min temperature 35°C, max 275°C

This setting saves energy while maintaining the quality of the cooking.

All types of cooking are done without preheating.



FULL GRILL

Min temperature 180°C, max 275°C

Recommended for toast, gratin dishes, browning crème brûlée, etc.



GRILL PULSE

Min temperature 100°C, max 250°C

Roasts and poultry are juicy and crisp all over.

Slide the drip tray on to the bottom shelf support.

Recommended for all spit-roasted poultry or meat, for sealing and thoroughly cooking a leg or a rib of beef. To retain the moist texture of fish steaks.

AUTOMATIC FUNCTIONS :

Brandt offers you 3 new functions which automatically combine two cooking modes: traditional cooking and steam cooking in order to preserve the nutritional qualities of food and achieve faster cooking.



WHITE MEAT

Recommended for preserving the mussel and fondant of pork and veal rotisseries.



FISH

Recommended for cooking whole fish or fillets.



POULTRY

Recommended for cooking chickens, turkeys, guinea fowl and ducks.

For these 3 functions, all you need to do is introduce lukewarm water in sufficient quantity into your dish (drip pan) and place it in your oven in the bottom tier and your food to be cooked in tier 3.

For the quantity of water to be introduced into the drip pan, refer to the table of automatic combined functions with steam association at the end of the manual.



"Smart Assist"

Your oven has the "SMART ASSIST" function which, when programming a cooking time, will suggest a cooking time which can be modified depending on the selected cooking mode.

**Cooking mode as per standard EN 60350-1: 2016 to demonstrate compliance with requirements of the energy label of European regulation UE/65/2014.*



How to use your appliance

STARTING COOKING

• Immediate cooking

The programmer must only display the time. It should not be flashing. Turn the function selector to any position.

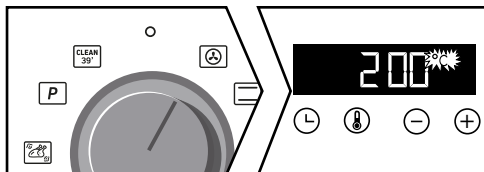



For manual functions :

The temperature rise starts immediately. Your oven recommends a modifiable temperature. The oven heats up and the temperature indicator flashes. A series of beeps will sound when the oven reaches the programmed temperature.

For automatic functions:

 appears on the screen.

Select your food using the table at the end of the manual. Press the + and - keys until you obtain the desired diagram in the display, then confirm with .

A weight flashes; enter the actual weight of your food with the + and - keys then validate with .

You have nothing else to adjust, the temperature and the cooking time are calculated automatically. The end of cooking time flashes, confirm with . Your cooking starts immediately.



• Changing the temperature

Press .

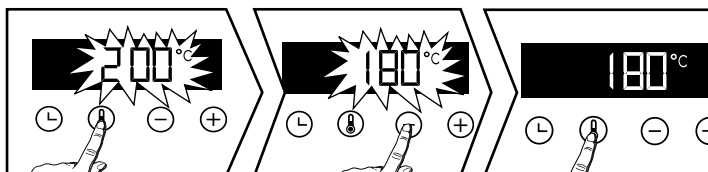
Adjust the temperature with + or -. Confirm by pressing .



• Programming the cooking time

Use the immediate cooking programme, then press , the cooking time flashes  and it is now possible to set it. Press + and - to adjust the cooking time.

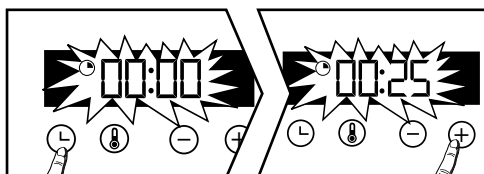



How to use your appliance



"Smart Assist"

Your oven has the "SMART ASSIST" function which, when programming a cooking time, will suggest a cooking time which can be modified depending on the selected cooking mode. See the table opposite:

The cooking time is saved automatically after a few seconds. The time starts to count down as soon as the cooking temperature is reached.

COOKING MODE	TIME
	30 min
	30 min
	30 min
ECO	30 min
	7 min
	15 min

- **Delayed start**

Proceed as for programmed cooking. After setting the cooking time, press the cooking end time flashes.

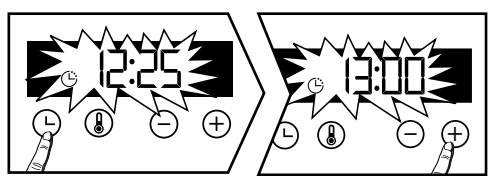

The display flashes. Set the cooking end time with + and - . The cooking end time is automatically saved after a few seconds. The cooking end time display stops flashing.



Cleaning

CLEANING INSIDE - OUTSIDE

• Self-cleaning of the cavity by pyrolysis





Warning

Remove the accessories and wire tiers from the oven before starting a pyrolysis cleaning. Before starting a pyrolysis cleaning of your oven, remove any large overflows that may have occurred. Remove excess grease from the door with a damp sponge.

For safety reasons, the pyrolysis cleaning operation is only carried out after the door has been automatically locked, the door cannot be unlocked.

• Immediate self-cleaning

The timer should display the time of day, without flashing. Select one of the self-cleaning cycles with the function lever  or  :

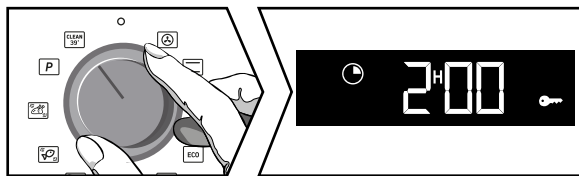



= Cleaning in 39 minutes

- At the end of each cooking cycle, "Clean 39" scrolls on the screen, suggesting that you start the cleaning process. Position the lever on this function and confirm with the key . The time 0:39 is displayed alternating with "Clean 39", your cleaning starts. After a few minutes, a key appears and the oven door is automatically locked for safety reasons during the entire programme.

If you wish to start a "Clean 39" oven that is cold or not hot enough, the program start conditions will not allow this cleaning to take place. 0:00 will appear on the display and you will have to select the other self-cleaning position.  .

= Pyrolysis of 2 hours. Set the joystick to this function.



Set the joystick to this function.  is displayed on the screen. Press + to choose your pyrolysis according to the degree of soiling of your oven.

Depending on your choice, the duration 2:00 is displayed. Confirm with the .  displayed, the pyrolysis starts.

At the end of the cleaning process the display shows 0:00 and the door unlocks.

Reset the function selector switch to 0.

• Delayed self-cleaning

You have the possibility to postpone the departure of your Pyrolysis. When the duration of the programme is shown on the display, press the button  and set the new end time using the + and - keys, then confirm with . Self-cleaning will start later and finish at the new programmed time. Reset the function selector switch to 0 at the end of the cleaning process.



Cleaning

• Cleaning the outer surfaces

Use a window washing product applied to a soft cloth. Do not use abrasive creams or scouring sponges.

• Cleaning the shelf supports

Lift the front part of the wire shelf support upwards. Press the entire shelf support and release the front hook from its housing. Then gently pull the whole of the support towards you to release the rear hooks from their housing. Pull out the two shelf supports.

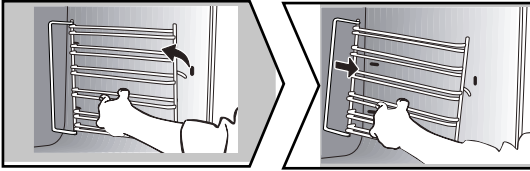

• Cleaning the inside glass

Warning

Do not use scouring cleaning products, abrasive sponges or metal scrapers to clean the oven's class door, which may scratch the surface and lead to the glass breaking.

To clean the inside glass, remove the door. Before doing this, remove any excess grease with a soft cloth and washing up liquid.

• Cleaning the inside glass

Open the door fully and block it with the plastic wedge provided in your appliance's plastic pouch.

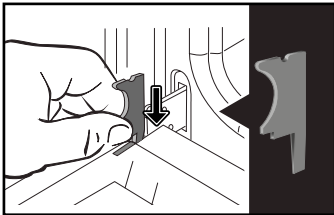

Use a tool (screwdriver) to press the slots **A** in order to unclip the glass panel. Remove the glass panel.



Important :

Make sure to mark the mounting direction of this first window (shiny side towards you).



Cleaning



Depending on the model, the door consists of two additional glass panels, with a black rubber spacer at each corner. If necessary, remove them to clean.

Do not soak the glass panels in water. Rinse with clean water and dry off with a lint-free cloth.

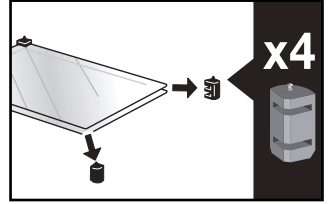
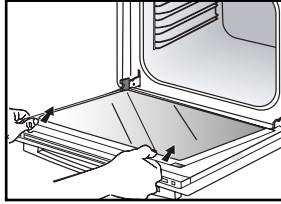
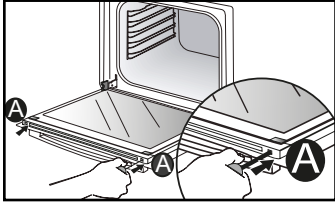

• Re-assembling the door

After cleaning, reposition the four rubber stops with the arrow upwards.

Reposition all of the glass panels.

Slip the last glass panel into the metal stops, then clip it in with the shiny side facing outwards.

Remove the plastic wedge.

Your appliance is now ready for use again.

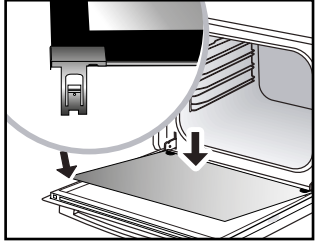
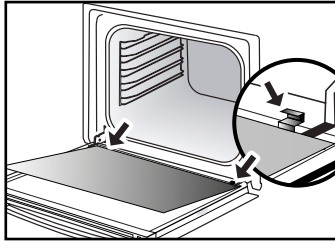
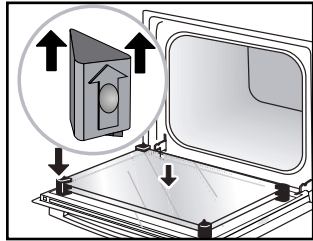

• Replacing the oven lamp



Warning:

Make sure the appliance is disconnected from the power before replacing the lamp in order to avoid the risk of electric shock. Change the lamp only when the appliance has cooled down.

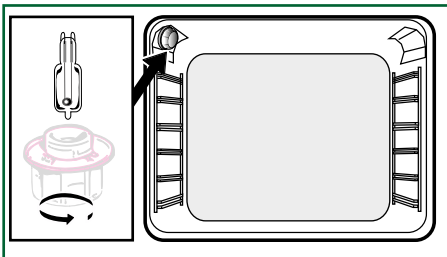

Bulb specification:

25 W, 220-240 V~, 300°C, G9 cap.

To unscrew the view port and the light, use a rubber glove, which will make disassembly easier.



ANOMALIES AND SOLUTIONS

The oven is not heating. Check that the oven is correctly connected and that your installation's fuse is not out of service. Increase the selected temperature.

The oven light is not working. Replace the bulb or the fuse. Check that the oven is correctly connected.

The cooling fan continues to operate after the oven stops. This is normal; the fan may continue running until a maximum of 1 hour after cooking to lower the temperature inside and outside the oven. If the fan runs for over an hour, contact the After Sales Department.

The pyrolysis cleaning cycle does not begin. Check that the door is locked. If there is a door locking or temperature sensor fault, contact the Customer Services Department.

The symbol  flashes in the display.

Door locking fault; contact the Customer Services Department.

Vibration noise.

Check that the power cord is not in contact with the rear wall.

This does not affect the proper operation of your unit, but may generate vibration noise during ventilation. Remove your unit and move the cord. Replace your oven.



SERVICE CALLS

Any repairs made to your appliance must be carried out by a qualified professional authorised to work on the brand. When calling, please provide the complete references of your appliance (commercial reference, service reference, serial number), so that we can handle your call better. This information appears on the manufacturer's nameplate attached to your equipment.

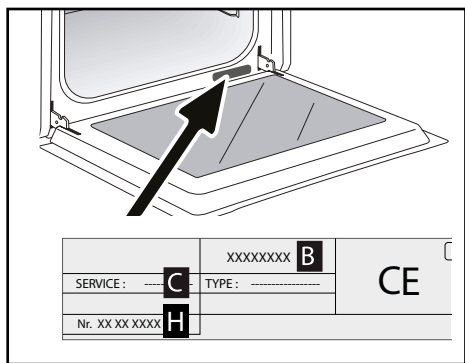

B: Commercial reference

C: Service reference

H: Serial number

GENUINE REPLACEMENT PARTS

During maintenance work, request that only certified genuine replacement parts are used.





DISHES															min
Meat															
Roast pork (1kg)	200	2						180	2						60
Roast veal (1kg)	200	2					180	2							60-70
Roast beef	240	2													30-40
Lamb (leg, shoulder, 2.5kg)	220	1			220					200	2				60
Poultry (1kg)	200	2			220		180	2		210	3				60
Large pieces of poultry	180	1													60-90
Chicken thighs					220	3				210	3				20-30
Pork/veal chops					210	3									20-30
Beef ribs (1kg)					210	3				210	3				20-30
Lamb chops					210	3									20-30
Fish															
Grilled fish					275	4									15-20
Cooked fish (bream)	200	3					180	3							30-35
Fish in papillotte	220	3					200	3							15-20
Vegetables															
Gratins (cooked foods)					275	2									30
Potato gratin	200	2					180	2							45
Lasagne	200	3					180	3							45
Stuffed tomatoes	170	3					160	2							30
Pastries															
Sponge cake			180	2									180	2	35
Swiss roll	220	3											180	2	5-10
Buns	180	1	210										180	2	35-45
Brownies	180	2					175	3							20-25
Cake - Pound cake	180	1	180	1									180	2	45-50
Clafoutis	200	2					180	3							30-35
Baked custards	165	2											150	2	30-40
Cookies - Shortbread	175	3													15-20

* Depending on the model



DISHES									
									min

Pastries

Madeleines	220	3					200	3										5-10	
Choux pastry	200	3					180	3									180	3	30-40
Flaky pastry hors d'oeuvres	220	3					200	3											5-10
Savarin cake	180	3															175	3	30-35
Shortcrust tart	200	1					195	1											30-40
Thin flaky crust tart	215	1					200	1											20-25
Tart made with yeast-based pastry	210	1					200	1											10-30

Other

Skewers	220	3				210	4												10-15
Terrine pâté	200	2						190	2										80-100
Shortcrust pizza	200	2																	30-40
Dough-based pizza																			15-18
Quiches																			35-40
Soufflé																	180	2	50
Pies	200	2																	40-45
Bread	220						200		220										30-40

* Depending on the model

All T°C and cooking times are given for pre-heated ovens.

N.B: Before being placed in the oven , all meat must remain at least 1 hour at room temperature.

RELATIONSHIP OF SETTINGS TO TEMPERATURE T °F / °C									
Setting	1	2	3	4	5	6	7	8	9 maxi
° Fahrenheit	85	140	195	250	300	355	410	465	525



Recipe with yeast (depending on model)

Ingredients:

● Flour 2 kg ● Water 1240 ml ● Salt 40 g ● 4 packets of dehydrated baker's yeast

Mix the dough in a mixer and allow to rise in the oven.

Method: For yeast-based pastry recipes. Pour the dough into a heat-resistant dish. Remove the wire shelf supports and put the dish on the bottom.

Pre-heat the oven to 40–50°C with the circulating heat function for five minutes. Stop the oven and allow the dough to rise for 25-30 minutes thanks to the residual heat.

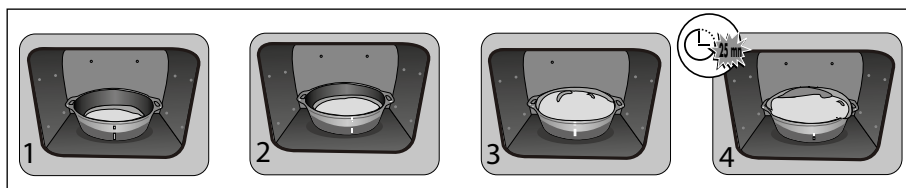



PERFORMANCE TESTING ACCORDING TO STANDARD CEI 60350













FOOD	* Cooking modes	SHELF	ACCESSORIES	°C	TIME min.	PREHEAT
Shortbread (8.4.1)		5	Deep Tray 45mn	150	30-40	yes
Shortbread (8.4.1)		5	Deep Tray 45mn	150	25-35	yes
Shortbread (8.4.1)		2 + 5	Deep Tray 45mn + grill	150	25-45	yes
Shortbread (8.4.1)		3	Deep Tray 45mn	175	25-35	yes
Shortbread (8.4.1)		s	Deep Tray 45mn + grill	160	30-40	yes
Small cakes (8.4.2)		5	Deep Tray 45mn	170	25-35	yes
Small cakes (8.4.2)		5	Deep Tray 45mn	170	25-35	yes
Small cakes (8.4.2)		2 + 5	Deep Tray 45mn + grill	170	20-40	yes
Small cakes (8.4.2)		3	Deep Tray 45mn	170	25-35	yes
Small cakes (8.4.2)		2 + 5	Deep Tray 45mn + grill	170	25-35	yes
Fatless sponge cake (8.5.1)		4	Grill	150	30-40	yes
Fatless sponge cake (8.5.1)		4	Grill	150	30-40	yes
Fatless sponge cake (8.5.1)		2 + 5	Deep Tray 45mn + grill	150	30-40	yes
Fatless sponge cake (8.5.1)		3	Grill	150	30-40	yes
Fatless sponge cake (8.5.1)		2 + 5	Deep Tray 45mn + grill	150	30-40	yes
Apple pie (8.5.2)		1	Grill	170	90-120	yes
Apple pie (8.5.2)		1	Grill	170	90-120	yes
Apple pie (8.5.2)		3	Grill	180	90-120	yes
Surface browning (9.2.2)		5	Grill	275	3-6	yes

*Depending on the model

N.B. : To cook on 2 levels, dishes can be taken out at different times.



TABLE OF COMBINED FUNCTIONS AUTOMATIC WITH VAPOR ASSOCIATION

Position of	Display in programmer	Food	Amount of water to add
		Chicken	500 ml lukewarm water in the multipurpose tray
		Duck	500 ml lukewarm water in the multipurpose tray
		Turkey	500 ml lukewarm water in the multipurpose tray
		Pintade	800 ml lukewarm water in the multipurpose tray
		Whole fish (large)	500 ml lukewarm water in the multipurpose tray
		Whole fish (flat)	300 ml lukewarm water in the multipurpose tray
		Small whole fish	300 ml lukewarm water in the multipurpose tray
		Fish fillets	300 ml lukewarm water in the multipurpose tray
		Roast pork	500 ml lukewarm water in the multipurpose tray
		Roast veal	500 ml lukewarm water in the multipurpose tray

IMPORTANT

Insert the multipurpose tray (with lukewarm water) in the lower shelf, level 1 and your food to be cooked in the shelf level 3.



- EN Information for domestic ovens (UE n° 662014)
- DE Informationen zu Haushaltsbacköfen (UE n° 662014)
- FR Informations concernant les fours domestiques (UE n° 662014)
- ES Información sobre los hornos domésticos (UE n° 662014)
- CS Informační údaje pro domácí troubu (UE n° 662014)
- IT Informazioni relative ai forni domestici (UE n° 662014)
- NL Informatie met betrekking tot huishoudelijke ovens (UE n° 662014)
- DK Oplysninger for ovne til husholdningsbrug (UE n° 662014)
- PL Informacje dotyczące piekarników (UE n° 662014)
- FI koteloitten uunien tiedot (UE n° 662014)

EN Symbol	Unit	Value	KCD25P	KHT25P	KHT15P	KHT25P	KHT15P	KHT25P	KHT15P	KHT25P	KHT15P	KHT25P	KHT15P
Type norme													
Models identification													
Type of oven													
Mass of the appliance	M	34,6	30,7	35,7	33,6	36,2	36,6	33,0	33,6	36,6	38,0	38,0	43,1
Number of cavities		1	1	1	1	1	1	1	1	1	1	1	1
Heat source per cavity (electricity or gas)													
Volume per cavity	V	73,0	73,0	73,0	73,0	73,0	73,0	73,0	73,0	73,0	73,0	73,0	73,0
Energy consumption (required to heat a standardised load in electric mode per cycle)	EC electric load in kWh/cycle	0,82	0,82	0,69	0,70	0,70	0,70	0,70	0,70	0,70	0,70	0,70	0,70
Energy consumption (required to heat a standardised load in gas mode per cycle)	GC gas load in kWh/cycle												
Energy Efficiency Index per cavity	EI	90,3	86,3	80,2	81,4	81,4	81,4	81,4	81,4	81,4	81,4	81,4	81,4

Brandt

FR

CS

DA

DE

EL

EN

ES

FI

IT

NL

NO

PL

PT

SK

SV



INSTRUCCIONES PARA EL USUARIO ES

HORNO

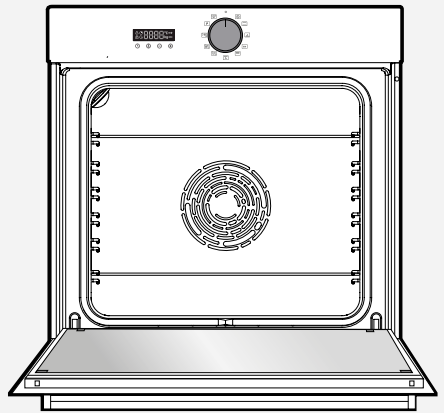

ORIGINE
FRANCE[®]
GARANTIE

BYCert.6011825

Estimado/a cliente/a,

Le agradecemos la confianza que ha depositado en nosotros al adquirir este producto **BRANDT**.

Hemos diseñado y fabricado este producto pensando en usted, en su modo de vida y en sus necesidades para poder satisfacer mejor sus expectativas. animados por el espíritu innovador y la pasión que nos caracteriza desde hace más de 60 años.

Para responder a todas sus necesidades, tenemos un servicio de atención al cliente a su disposición que atenderá todas sus preguntas y sugerencias.

También puede visitar nuestra página web **www.brandt.com** donde encontrará nuestras últimas novedades, así como información útil y complementaria.

En BRANDT nos sentimos orgullosos de acompañarle en su día a día y le deseamos que disfrute plenamente de su compra.

	<p>La etiqueta "Origine France Garantie" garantiza al consumidor la trazabilidad de un producto al proporcionar una indicación clara y objetiva de la fuente. La marca Brandt se enorgullece de colocar esta etiqueta en los productos de nuestras fábricas francesas con sede en Orleans y Vendôme.</p>
--	--

<https://brandt.com/>

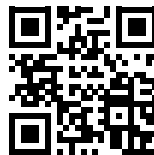

Importante:

antes de utilizar el aparato por primera vez, lea atentamente este manual para familiarizarse más rápidamente con su funcionamiento.



INSTRUCCIONES DE SEGURIDAD	4
MEDIO AMBIENTE Y AHORRO DE ENERGÍA	7
Medio ambiente	7
Consejo de Ahorro de Energía	7
INSTALANDO SU DISPOSITIVO	7
Elección de la ubicación e instalación	8
Conexión eléctrica.....	10
DESCRIPCIÓN DE SU DISPOSITIVO	11
Presentación del horno.....	11
Teclas de visualización y control.....	12
Accesorios	13
USANDO SU DISPOSITIVO	14
Ajustes	14
Menú de ajustes.....	15
Modos de cocción.....	16
Iniciar un proceso de cocción.....	17
EL CUIDADO DE SU DISPOSITIVO	19
Limpieza interior - exterior	19
ANOMALÍAS Y SOLUCIONES.....	20
SERVICIO POSTVENTA	21
Intervenciones.....	21
AYUDA DE COCINA.....	22
Cocinas.....	22
Recetas con levadura	24
Pruebas de aptitud a la función.....	25
Funciones automáticas de vapor combinado	26



INSTRUCCIONES DE SEGURIDAD IMPORTANTES - LÉALAS CON ATENCIÓN Y CONSERVELAS PARA CONSULTARLAS EN EL FUTURO.

Este manual se encuentra disponible para descarga en la página web de la marca.

Cuando reciba el aparato, desembálelo o hágalo desembalar inmediatamente. Compruebe su aspecto general. Si tiene reservas que señalar, hágalo por escrito en el albarán de entrega y quédese con un ejemplar.

Importante:

Este aparato se puede utilizar por niños de 8 años y más y por personas con capacidades físicas, sensoriales o mentales reducidas o carentes de la experiencia y del conocimiento si han podido beneficiar de una vigilancia o de instrucciones previas sobre la utilización del aparato de forma segura y han comprendido los riesgos incurridos.

— Los niños no deben jugar con el aparato. Las operaciones de limpieza y de mantenimiento no deben ser realizadas por niños sin vigilancia.

— Conviene vigilar a los niños para asegurarse de que no jueguen con el aparato.

ADVERTENCIA:

— El aparato y sus partes accesibles se calientan durante la utilización. No debe tocar los elementos calientes situados en el interior del horno.

Mantenga alejados a los niños menores de 8 años o vigílelos permanentemente.

— Este aparato ha sido diseñado para realizar cocciones con la puerta cerrada.

— Antes de proceder a la limpieza con función pirólisis del horno, retire todos los accesorios y elimine las salpicaduras importantes.

— Durante una limpieza, las superficies accesibles se calientan más que durante un uso normal.

Se recomienda alejar a los niños.

— No utilice un aparato de limpieza a vapor.

— No utilice productos de limpieza abrasivos ni estropajos metálicos duros para limpiar la puerta de cristal del horno, ya que podrían rayar la superficie y provocar la rotura del cristal.

ADVERTENCIA :

Para evitar cualquier riesgo de electrocución, asegúrese de que el aparato esté desconectado de la alimentación antes de cambiar la bombilla. Realice la intervención cuando el aparato se haya enfriado. Para desatornillar la tulipa y la bombilla, utilice un



guante de goma que facilitará el desmontaje.

El enchufe debe estar accesible después de realizar la instalación. El aparato se debe poder desconectar de la red eléctrica, bien por medio de un enchufe o bien incorporando un interruptor en las canalizaciones fijas siguiendo las normas de instalación.

— Si el cable de alimentación está dañado, debe ser reemplazado por el fabricante, su servicio de postventa o una persona de calificación similar para evitar un peligro.

— Este aparato puede instalarse indiferentemente bajo un plano o en una columna tal como se indica en el esquema de instalación.

— Centre el horno en el mueble respetando una distancia mínima de 5 mm con el mueble contiguo. El material del mueble de empotramiento debe ser resistente al calor (o estar recubierto con un material resistente). Para más estabilidad, fije el horno en el mueble con 2 tornillos, a través de los orificios previstos para dicho fin en los montantes laterales.

— El aparato no debe instalarse detrás de una puerta decorativa, con el fin de evitar un recalentamiento.

— Este aparato está destinado

para ser utilizado en aplicaciones domésticas y análogas como: Pequeñas cocinas reservadas al personal de tiendas, oficinas y entornos profesionales.

Granjas. La utilización por clientes de hoteles, moteles y otros entornos de carácter residencial, entornos de tipo habitaciones de huéspedes.

— Para cualquier intervención de limpieza en la cavidad del horno, éste debe estar apagado.

No modifique las características de este aparato; hacerlo representaría un peligro para usted.

No utilice el horno como despensa o para guardar accesorios después de su utilización.



RESPECTO DEL MEDIO AMBIENTE

- Los materiales del embalaje de este aparato son reciclables. Participe en su reciclaje y ayude a proteger el medio ambiente llevándolos a los contenedores municipales previstos para ello.



- Su aparato contiene también numerosos materiales reciclables. Por ello ha sido marcado con este logotipo que indica que los aparatos viejos no se deben mezclar con los demás residuos.

- De este modo, el reciclaje de los aparatos que organiza el fabricante se efectuará en óptimas condiciones, de acuerdo con la Directiva Europea 2002/96/CE sobre los residuos de equipos eléctricos y electrónicos.

- Pregunte en su ayuntamiento o al vendedor para conocer los puntos de recogida de aparatos viejos más cercanos a su domicilio.

- Le agradecemos su colaboración con la protección del medio ambiente.

JUNTA DE AHORRO DE ENERGÍA

Durante la cocción, mantenga la puerta del horno cerrada.

ENVASES

- Esta marca "Green Dot" significa que, para el envase de este aparato, se ha pagado una contribución financiera a una empresa nacional de recuperación de envases.





ELECCIÓN DEL EMPLAZAMIENTO Y EMPOTRAMIENTO

Los esquemas determinan las cotas de un mueble en el que será posible colocar el horno. Este aparato se puede instalar indistintamente bajo una encimera (A) o en columna (B). Si el mueble está abierto, su apertura debe ser de 70 mm como máximo en su parte posterior.

Fije el horno al mueble. Para ello, retire los toques de goma y perforo un orificio de $\varnothing 2$ mm en la pared del mueble para evitar que se agriete la madera. Fije el horno con los 2 tornillos. Vuelva a colocar los toques de goma.



Consejo

Para estar seguro de que la instalación es adecuada, no dude en recurrir a un especialista en electrodomésticos.



Atención:

Si la instalación eléctrica de la habitación obliga a efectuar una modificación para poder conectar el aparato, llame a un electricista cualificado. Si el horno presenta alguna anomalía, desconecte el aparato o quite el fusible correspondiente a la línea de conexión del horno.

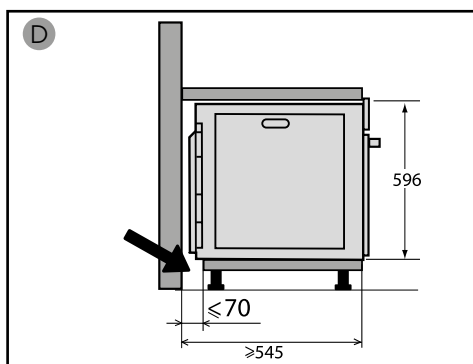
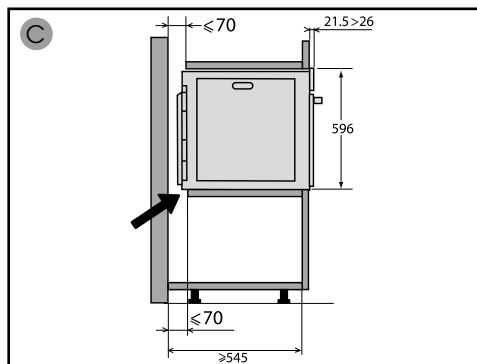
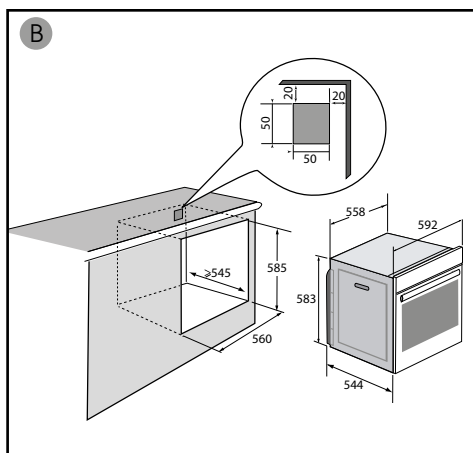
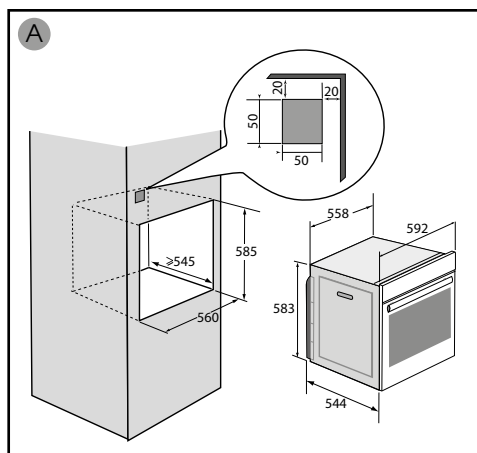



CONEXIÓN ELÉCTRICA

El horno debe estar conectado con un cable de alimentación normalizado con 3 conductores de 1,5 mm² (1 f + 1 N + tierra) conectados a la red de 220~240 voltios por medio de una toma de corriente normalizada CEI 60083 o de un dispositivo de corte omnipolar de acuerdo con las normas de instalación.



Atención:

El cable de protección (verde-amarillo) va conectado al borne  del aparato y también hay que conectarlo a la tierra de la instalación. El fusible de la instalación debe ser de 16 amperios.

No se asumirá ningún tipo de responsabilidad en caso de accidente o incidente debido a una falta de conexión de toma de tierra o a una toma de tierra defectuosa o incorrecta, ni en el caso de una conexión incorrecta.

• Antes del primer uso

Antes de usar el horno por primera vez, caliéntelo vacío con la puerta cerrada durante unos 15 minutos a la temperatura más alta. para romper el aparato. La lana mineral que rodea la cavidad del horno puede inicialmente emitir un olor particular debido a su composición. También puede notar que el humo proviene de la lana mineral. Esto es normal.

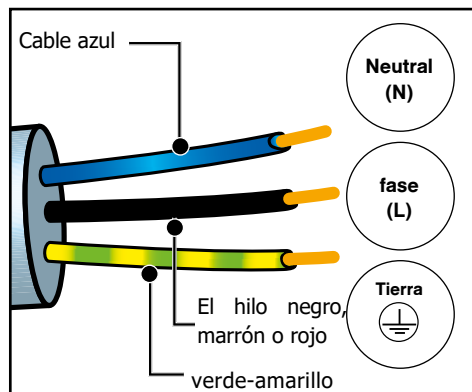



Presentación del horno

PRESENTACIÓN DEL HORNO

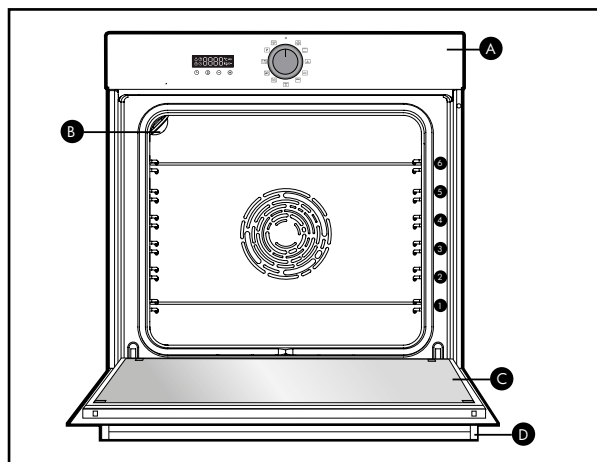

- A** Panel de mandos
- B** Lámpara
- C** Puerta
- D** Empuñadura

Este horno dispone de 6 posiciones de niveles para los accesorios: niveles 1 a 6.

TECLAS DE VISUALIZACIÓN Y CONTROL S

PANTALLA



- Tiempo de cocción
- Fin de la cocción
- Bloqueo del teclado
- Temporizador
- Indicador de temperatura
- Indicador de precalentado
- Bloqueo de la puerta

TECLAS

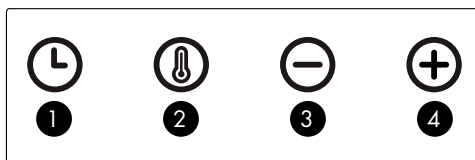

- 1** Selección de hora y tiempo
- 2** Selección de temperatura
- 3** Tecla -
- 4** Tecla +



ACCESORIOS

• Parrilla de seguridad antivuelco

La parrilla se puede utilizar como soporte para bandejas y fuentes con alimentos para asar o gratinar. También se puede utilizar para asados a la parrilla (que se colocarán directamente encima). Introduzca la parrilla de seguridad antivuelco hacia el fondo del horno.

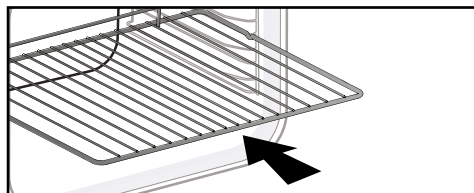

• Bandeja multiusos recogejugos de 45 mm

Se inserta en los niveles por debajo de la parrilla con la empuñadura hacia la puerta del horno. Recoge los jugos y grasas de los asados; también se puede utilizar llena de agua hasta la mitad para cocciones al baño maría.



• Plato de pastelería 20mm

Para insertar en los niveles, empuñadura frente a usted. Ideal para hornear galletas, galletas de mantequilla, magdalenas. Su inclinación le permite colocar fácilmente sus preparaciones en un plato. Colocada en los alojamientos bajo la parrilla, recoge el jugo y la grasa de los asados

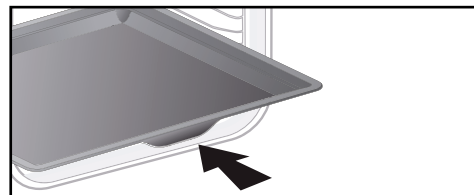

• Sistema de guías telescópicas

Gracias al nuevo sistema de guías telescópicas, la manipulación de los alimentos resulta más práctica y fácil, ya que las bandejas se pueden extraer suavemente, simplificando al máximo manipulación. Las bandejas son totalmente extraíbles ofreciendo una accesibilidad total.

Además, su estabilidad permite trabajar y manipular los alimentos con total seguridad, reduciendo el riesgo de sufrir quemaduras. De este modo puede retirar los alimentos del horno mucho más fácilmente.

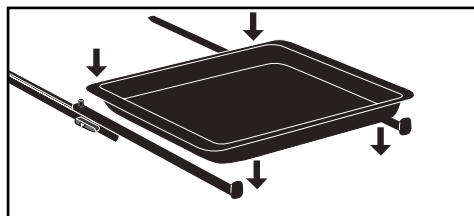

Atención:

Retire los accesorios y los niveles del horno antes de iniciar una limpieza por pirólisis.



Advertencia:

Bajo el efecto del calor, los accesorios pueden deformarse sin afectar su función. Volverán a su forma original cuando se enfríen.



Presentación del horno

INSTALACIÓN Y DESMONTAJE DE LAS GUÍAS TELESCÓPICAS

Tras haber retirado los 2 niveles, escoja la altura (de 2 a 5) en la que quiera fijar las guías. Encaje la guía izquierda en el nivel izquierdo efectuando una presión suficiente en la parte delantera y trasera de la guía para que las 2 patas de lateral de la guía se introduzcan en el nivel.

Proceda del mismo modo para la guía derecha.

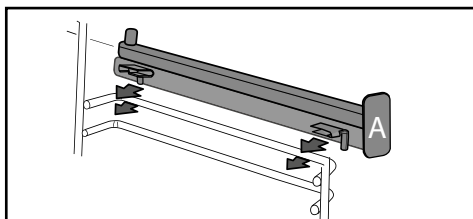

NOTA : la parte telescópica deslizante de la guía se despliega hacia la parte delantera del horno, con el tope **A** orientado hacia usted.

Coloque los dos niveles y luego la placa sobre las 2 guías ; el sistema está listo para utilizarse.

Para desmontar las guías, retire de nuevo los niveles.

Incline ligeramente hacia abajo las patas fijadas a cada guía para liberarlas del nivel. Tire de la guía hacia usted.

Para desmontar las guías, retire de nuevo los niveles.

Incline ligeramente hacia abajo las patas fijadas a cada guía para liberarlas del nivel. Tire de la guía hacia usted.

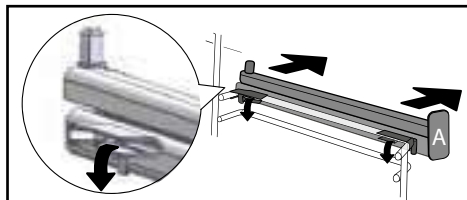
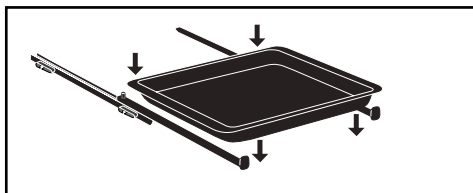

Consejo

Con el fin de evitar emisiones de humo durante la cocción de carnes grasas, le recomendamos añadir una pequeña cantidad de agua o de aceite en el fondo de la bandeja recogejugos.





Usando tu aparato

RÉGLAGES

• Puesta en hora

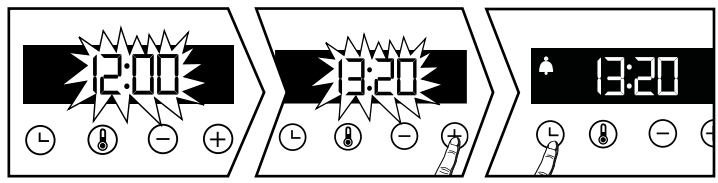
Al conectar el aparato, la pantalla parpadea a las 12:00.





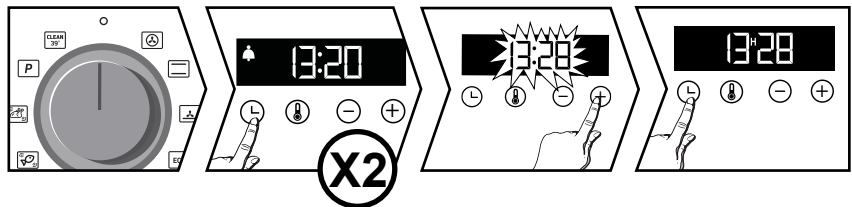

Establezca la hora con las teclas + o -. Confírmela con la tecla . En caso de un corte de corriente, la visualización de la hora parpadeará para indicarle la hora del corte.

• Cambio de la hora

El selector de función debe estar obligatoriamente en la posición 0.



Pulse la tecla  y aparecerá el símbolo del temporizador . Vuelva a pulsar  y ajuste la hora con las teclas + o -.

Confírmela con la tecla . La grabación del tiempo ajustado es automática después de unos segundos.

• Temporizador

Esta función sólo puede utilizarse cuando el horno está apagado.

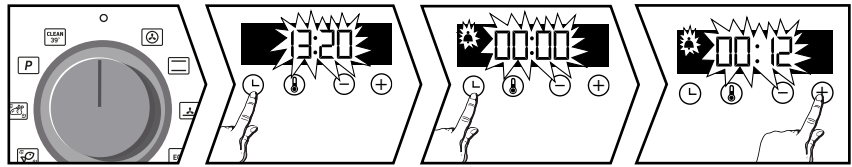

El selector de función debe estar obligatoriamente en la posición 0.

Pulse la tecla  y aparecerá el símbolo del temporizador . Ajuste la hora con las teclas + o -.



NB: Puedes cambiar o cancelar la programación del temporizador en cualquier momento. Para cancelar, vuelva al menú del temporizador y establezca las 00:00. Sin la validación, la grabación se hará automáticamente después de unos segundos.

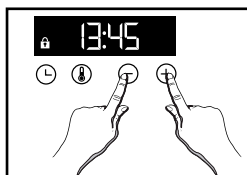

Usando tu aparato

• Bloqueo del teclado



Pulse simultáneamente las teclas + y - hasta que aparezca el símbolo  Para desbloquearlo, pulse simultáneamente las teclas + y - hasta que desaparezca el símbolo  de la pantalla.

MENÚ



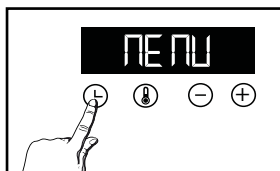

Puede modificar diferentes parámetros de su horno, para ello:

Pulse la tecla  hasta que aparezca "MENÚ" para acceder al modo de ajustes.



Vuelva a pulsar la tecla  para desplazarse por los diferentes ajustes.

Active o desactive con las teclas + y - los diferentes parámetros. Consulte la siguiente tabla:

	AUTO: En modo de cocción la lámpara de la cavidad del horno se apaga al cabo de 90 segundos. ENCENDIDO: En modo de cocción la lámpara está siempre encendida.
	Activar/desactivar los tonos de las teclas
	Activar/desactivar el modo de demostración
	Activar/desactivar el modo de precalentado

Para salir del «MENÚ», pulse de nuevo .



Usando tu aparato

MODOS DE COCCIÓN (según el modelo)

Funciones manuales:



CALOR GIRATORIO*

Temperatura mínima 35°C - máxima 250°C
Recomendado para conservar la ternura de la carne blanca, el pescado y las verduras. Para las cocciones múltiples de hasta 3 niveles.



TRADICIONAL

Temperatura mínima 35°C - máxima 275°C
Recomendado para las cocciones lentas y delicadas: caza tierna, etc. Para soasar asados de carne roja. Para cocer a fuego lento en una cacerola cerrada los platos previamente cocinados en la placa de cocción (gallo al vino, liebre, etc.).



SOLERA CON AIRE IMPULSADO

(Temperatura mínima 75°C máxima de 250°C)
Recomendado para platos húmedos (quiches, tartas de frutas jugosas, etc.). La masa quedará bien cocida por debajo. Recomendado para las preparaciones que deben subir (cake, brioche, kouglouf...) así como para los soufflés, que no quedarán bloqueados por la costra formada encima.



ECO*

Temperatura mínima 35°C - máxima 275°C
Esta posición permite ahorrar energía conservando las cualidades de la cocción.
Todas las cocciones se realizan sin precalentamiento.



GRILL FUERTE

Temperatura mínima 180°C - máxima 275°C
Recomendado para tostar pan, gratinar un plato, dorar una crema catalana, etc.



GRILL CON AIRE IMPULSADO

Temperatura mínima 100°C - máxima 250°C
Aves y asados jugosos y crujientes por todos los lados.

Coloque la bandeja recogejugos en el nivel más bajo. Recomendado para todas las aves o asados hechos, para soasar y cocinar hasta el centro piernas de cordero, chuletas de buey. Para que las piezas de pescado queden jugosas y tiernas.

Brandt le ofrece 3 nuevas funciones que combinan automáticamente dos modos de cocción: cocción tradicional y cocción al vapor para preservar las cualidades nutricionales de los alimentos y lograr una cocción más rápida.



CARNES BLANCAS

Recomendado para preservar el moho y el fondant de los asadores de cerdo y ternera.



PISCIS

Recomendado para cocinar pescado entero o en filetes.



AVES DE CORRAL

Recomendado para cocinar pollos, pavos, gallinas de Guinea y patos.

Para estas 3 funciones, todo lo que necesita hacer es introducir agua tibia en cantidad suficiente en su plato (bandeja multiusos) y colocarla en su horno en el nivel inferior y sus alimentos para cocinar en el nivel 3.

Para conocer la cantidad de agua que debe introducirse en la bandeja, consulte la tabla de funciones automáticas combinadas con asociación de vapor al final del manual.

**Modo de cocción efectuado siguiendo las indicaciones de la norma EN 60350-1: 2016 para demostrar el cumplimiento de las exigencias de etiquetado energético de la normativa europea UE/65/2014.*



"Smart Assist"

Su horno está equipado con la función «SMART ASSIST» la cual le recomendará durante la programación del tiempo, un tiempo modificable en función de la cocción seleccionada.



INICIAR UN PROCESO DE COCCIÓN

• Cocción inmediata

La pantalla solo debe mostrar el tiempo fijo.

Gire el selector de funciones a la posición que elija.

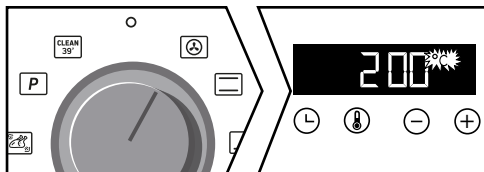

Para funciones manuales:

El aumento de temperatura comienza de inmediato. Su horno recomienda una temperatura modificable. El horno se calienta y el indicador de temperatura parpadea. Sonará una serie de pitidos cuando el horno alcance la temperatura programada.

Para funciones automáticas:

aparece en la pantalla.

Seleccione su comida usando la tabla al final del manual. Presione las teclas + y - hasta obtener el diagrama deseado en la pantalla, luego confirme con la tecla

Un peso parpadea; ingrese el peso real de su comida con las teclas + y - luego valide

No tiene nada más que ajustar, la temperatura y el tiempo de cocción se calculan automáticamente. El final del tiempo de cocción parpadea, confirme con la tecla . Tu cocina comienza de inmediato.

• Modificación de la temperatura

Pulse

Ajuste la temperatura con + o - confírmela pulsando

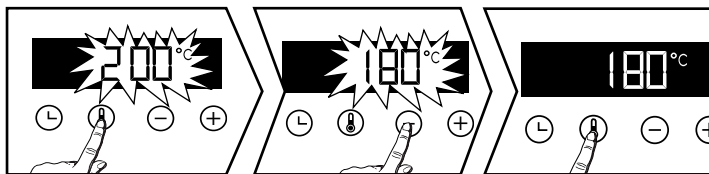

• Programación del tiempo

Efectúe una cocción inmediata y después pulse , el tiempo de cocción parpadeará y permitirá ajustarlo. Pulse + o - para ajustar el tiempo de cocción.

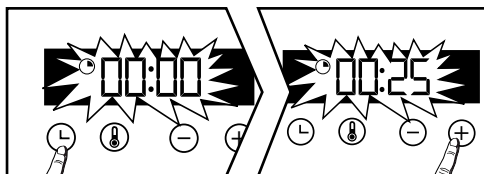



Sistema "Smart Assist"

Su horno está equipado con la función «SMART ASSIST» la cual le recomendará durante la programación del tiempo, un tiempo modificable en función de la cocción seleccionada.

Consulte la siguiente tabla:

El tiempo de cocción quedará automáticamente registrado al cabo de unos segundos. La cuenta atrás se inicia inmediatamente una vez alcanzada la temperatura de cocción.

FUNCIÓN DE COCCIÓN	RECOMENDACIÓN DE TIEMPO
	30 min
	30 min
	30 min
ECO	30 min
	7 min
	15 min

• Cocción con inicio diferido

Proceda igual que para un tiempo programado. Tras ajustar el tiempo de cocción, pulse la tecla , y parpadeará la hora de fin de cocción .

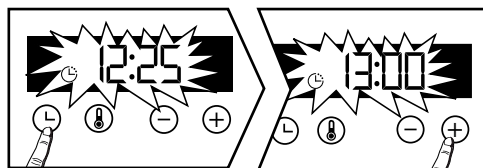

El indicador parpadeará; ajuste la hora de fin de cocción con + o -.

El final de cocción quedará automáticamente registrado al cabo de unos segundos. La pantalla de fin de cocción deja de parpadear.



LIMPIEZA DE LA SUPERFICIE EXTERIOR

• Auto-limpieza de la cavidad por pirólisis





Atención

Quita los accesorios y los cables del horno antes de empezar la limpieza por pirólisis. Antes de comenzar una limpieza de pirólisis de su horno, retire cualquier desbordamiento grande que pueda haber ocurrido. Quita el exceso de grasa de la puerta con una esponja húmeda.

Antes de proceder a una limpieza pirolítica de su horno, elimine las acumulaciones de grasa importantes que se hayan podido producir. Retire el exceso de grasa de la puerta con una esponja húmeda.

Como medida de seguridad, la operación de limpieza únicamente se efectúa tras el bloqueo automático de la puerta, y es imposible desbloquearla.

• Autolimpieza inmediata

El temporizador debe mostrar la hora del día sin parpadear. Seleccione uno de los ciclos de autolimpieza con el joystick.  o  :

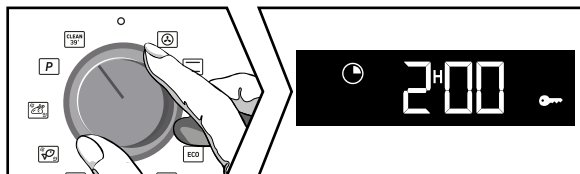

= Limpieza en 39 minutos

- Al final de cada ciclo de cocción, "Clean 39" se desplaza en la pantalla para iniciar el proceso de limpieza. Ponga la palanca en esta función y confirme con el . La hora 0:39 se muestra alternativamente con "Clean 39", su limpieza comienza. Después de unos minutos, aparece una llave y la puerta del horno se cierra automáticamente por razones de seguridad durante todo el programa.

Si desea iniciar un horno "Clean 39" que esté frío o no lo suficientemente caliente, las condiciones de inicio del programa no permitirán que se realice esta limpieza. En la pantalla aparecerá 0:00 y tendrá que seleccionar la otra posición de autolimpieza. .

= Una pirólisis de 2 horas. Ponga el joystick en esta función.



Ponga el joystick en esta función.  se muestra en la pantalla. Presiona + para elegir tu pirólisis según lo sucio que esté tu horno.

Dependiendo de su elección, la duración 2:00 se muestra. Confirme con el .  se muestra, la pirólisis comienza.

Al final del proceso de limpieza, la pantalla muestra las 0:00 y la puerta se abre.

Reajuste el interruptor del selector de funciones a 0.

• Retraso en la auto-limpieza

Tiene la posibilidad de posponer la salida de su Pirólisis. Cuando la duración del programa aparezca en la pantalla, pulse la tecla  y ajustar la nueva hora final con las teclas + y - y confirmar con . La autolimpieza comenzará más tarde y terminará a la nueva hora programada. Reajuste el interruptor del selector de funciones a 0 al final de la limpieza.



• Limpieza de la superficie exterior

Utilice un paño suave empapado con limpiacristales. No utilice cremas abrasivas, ni estropajos.

• Desmontaje de los niveles

Levante la parte delantera del panel de varillas, empújelo y haga salir el gancho delantero de su alojamiento. Tire después cuidadosamente del panel de varillas hacia usted para hacer salir los ganchos posteriores de su alojamiento. Retire los dos niveles.

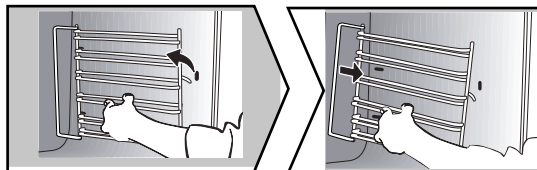

• Limpieza de los cristales interiores

Advertencia

No utilice productos de limpieza abrasivos, nanas ni raspadores metálicos para limpiar la puerta de cristal del horno, ya que se podría rayar la superficie y hacer que estallara el cristal.

Primero quita el exceso de grasa del cristal interior con un paño suave y un líquido lavavajillas. Para limpiar los vidrios interiores individuales, quítelos de la siguiente manera:

• Desmontaje de los cristales interiores

Abra la puerta por completo y bloquéela con la cuña roja de plástico incluida en la bolsa de plástico de su aparato.

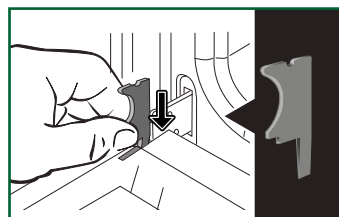

Extraiga el primer cristal enganchado:
Presione con una herramienta (destornillador) en los puntos A para desenganchar el cristal.



Importante:

Asegúrese de marcar la dirección de montaje de esta primera ventana (lado brillante hacia usted).



Limpeza

Según el modelo, la puerta se compone de dos cristales suplementarios, con un espaciador negro de goma en cada esquina. Si es necesario, retírelos para limpiarlos. No sumerja los cristales en el agua. Aclárelos con agua limpia y séquelos con un trapo que no suelte pelusa.

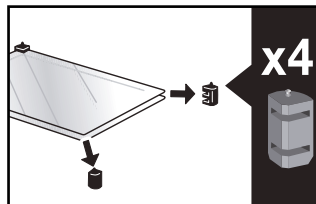
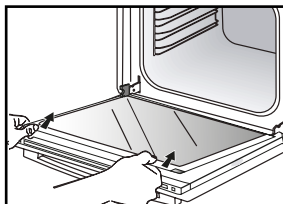
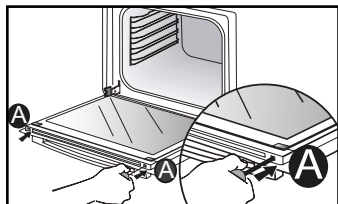

• Reinstalación de la puerta

Tras la limpieza, vuelva a colocar los cuatro topes de goma con la flecha hacia arriba y vuelva a colocar los cristales.

Introduzca el último cristal en los topes metálicos y engánchelo con la cara brillante hacia el exterior. Retire la cuña roja de plástico.

El aparato ya está nuevamente operativo.

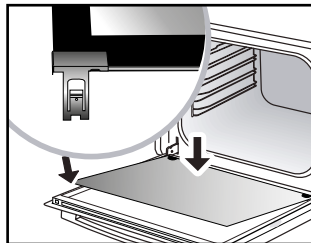
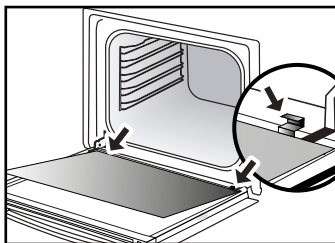
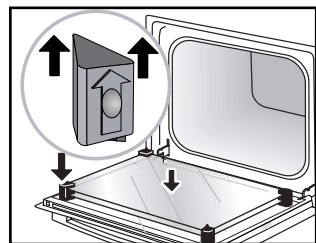

• CAMBIO DE LA LÁMPARA



Advertencia:

Para evitar cualquier riesgo de electrocución, asegúrese de que el aparato esté desconectado de la alimentación antes de cambiar la lámpara. Realice la intervención cuando el aparato se haya enfriado.

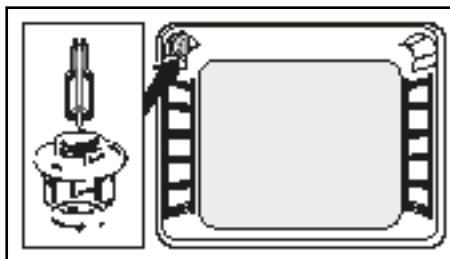

Características de la bombilla:

25 W, 220-240 V~, 300°C, casquillo G9.

Para desatornillar el plafón y la bombilla, utilice un guante de goma que facilitará el desmontaje.



Anomalías y soluciones

El horno no calienta. Compruebe que el horno esté bien enchufado y que el fusible de la instalación no esté fuera de servicio. Aumente la temperatura seleccionada.

La luz del horno no funciona. Cambie la bombilla o el fusible. Compruebe que el horno esté bien enchufado.

El ventilador de enfriamiento continúa funcionando cuando se para el horno. Es normal, la ventilación puede funcionar hasta un máximo de una hora después de la cocción para bajar la temperatura interior y exterior del horno. Si este proceso dura más de una hora, póngase en contacto con el Servicio Técnico.

La limpieza por pirólisis no se realiza. Compruebe el cierre de la puerta. Si se trata de un fallo del bloqueo de la puerta o del sensor de temperatura, llame al Servicio Técnico.

El símbolo parpadea  en la pantalla. Fallo del bloqueo de la puerta, llame al Servicio Técnico.

Ruido de vibración.

Compruebe que el cable de alimentación no esté en contacto con la pared posterior. Esto no tiene ningún impacto en el funcionamiento adecuado de su dispositivo, pero puede generar un ruido de vibración durante la ventilación. Retire su dispositivo y mueva el cable. Instale de nuevo su horno en su alojamiento.



INTERVENCIONES

Las posibles intervenciones necesarias en su aparato, deberán ser realizadas por un profesional cualificado depositario de la marca. Para facilitar el tratamiento de su solicitud, cuando llame no olvide dar las referencias completas del aparato (referencia comercial, referencia de servicio y número de serie). Esta información figura en la placa descriptiva.

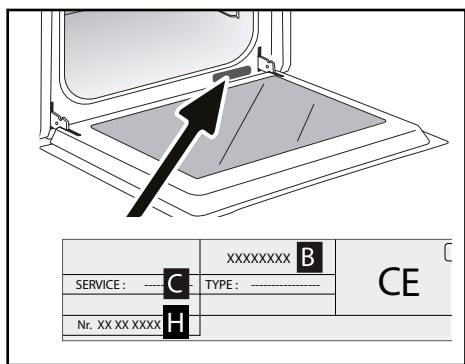

- B : Referencia comercial
- C : Referencia de servicio
- H : Número de serie

PIEZAS ORIGINALES

Si se debe realizar una intervención de mantenimiento, pida que se utilicen exclusivamente piezas de recambio certificadas originales.





PLATOS													min	
Carne														
Asado de cerdo (1kg)	200	2					180	2					60	
Asado de ternera (1kg)	200	2					180	2					60-70	
Asado de buey	240	2											30-40	
Cordero (pata, paletilla 2,5 kg)	220	1			220					200	2		60	
Aves (1 kg)	200	2			220		180	2		210	3		60	
Aves grandes piezas	180	1											60-90	
Muslos de pollo					220	3				210	3		20-30	
Costillas de cerdo / ternera					210	3							20-30	
Costillas de buey (1kg)					210	3				210	3		20-30	
Costillas de cordero					210	3							20-30	
Pescados														
Pescados asados					275	4							15-20	
Pescados cocinados (dorada)	200	3					180	3					30-35	
Pescados en papillote	220	3					200	3					15-20	
Verduras														
Gratenes (alimentos cocinados)					275	2							30	
Gratenes «dauphinois»	200	2					180	2					45	
Lasañas	200	3					180	3					45	
Tomates rellenos	170	3					160	2					30	
Pasteles														
Bizcocho esponjoso - Tarta			180	2								180	2	35
Brazo de gitano		3										180	2	5-10
Brioche	180	1	210									180	2	35-45
Brownies	180	2					175	3					20-25	
Bizcocho - cuatro cuartos	180	1	180	1								180	2	45-50
Tarta de cerezas	200	2					180	3					30-35	
Cremas	165	2										150	2	30-40
Galletas - Polvorones	175	3											15-20	

* según modelo

PLATOS													min		
	Pasteles														
Magdalenas	220	3						200	3					5-10	
Masa de buñuelos	200	3						180	3				180	3	30-40
Pastas hojaldradas	220	3						200	3						5-10
Pastel Savarin	180	3											175	3	30-35
Tarta de masa quebrada	200	1						195	1						30-40
Tarta de hojaldre fino	215	1						200	1						20-25
Tarta de masa con levadura	210	1						200	1						10-30
Varios															
Pinchos	220	3			210	4									10-15
Paté en terrina	200	2						190	2						80-100
Pizza masa quebrada	200	2													30-40
Pizza masa de pan															15-18
Quiches															35-40
Suflé													180	2	50
Empanadas	200	2													40-45
Pan	220							200		220					30-40
Pan tostado	180				275	4-5									2-3
Ollas cerradas (estofados)	180	2											180	2	90-180



CALIENTE PREVIAMENTE EL HORNO ANTES DE INTRODUCIR LAS BANDEJAS

Antes de introducirla en el horno, todas las carnes deben estar al menos 1 hora a temperatura ambiente.

EQUIVALENCIA : CIFRAS °C									
°C	30	60	90	120	150	180	210	240	275
Cifras	1	2	3	4	5	6	7	8	9 maxi



Receta con levadura (según el modelo)

Ingredientes:

● 2 kg de harina ● 1.240 ml de agua ● 40 g de sal ● 4 paquetes de levadura de panadería deshidratada.

Mezcle la masa con la mezcladora y haga subir la masa en el horno.

Procedimiento: Para las recetas de masa con levadura. Vierta la masa en una fuente resistente al calor, retire los paneles de varillas y coloque la fuente en la placa.

Pre caliente el horno con la función de calor giratorio a 40-50°C durante 5 minutos. Apague el horno y deje que la masa suba durante 25-30 minutos con el calor residual.

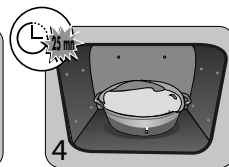



PRUEBAS DE APTITUD A LA FUNCION SEGUN NORMA CEI 60350

ALIMENTO	* MODOS DE COCCION	NIVEL	Accesorios	°C	TIEMPO min.	PRECALENTAMIENTO
Galletas de mantequilla (8.4.1)		5	bandeja 45 mm	150	30-40	SI
Galletas de mantequilla (8.4.1)		5	bandeja 45 mm	150	25-35	SI
Galletas de mantequilla (8.4.1)		2 + 5	bandeja 45 mm + parilla	150	25-45	SI
Galletas de mantequilla (8.4.1)		3	bandeja 45 mm	175	25-35	SI
Galletas de mantequilla (8.4.1)		2 + 5	bandeja 45 mm + parilla	160	30-40	SI
Magdalenas (8.4.2)		5	bandeja 45 mm	170	25-35	SI
Magdalenas (8.4.2)		5	bandeja 45 mm	170	25-35	SI
Magdalenas (8.4.2)		2 + 5	bandeja 45 mm + parilla	170	20-40	SI
Magdalenas (8.4.2)		3	bandeja 45 mm	170	25-35	SI
Magdalenas (8.4.2)		2 + 5	bandeja 45 mm + parilla	170	25-35	SI
Bizcocho esponjoso sin grasa (8.5.1)		4	parilla	150	30-40	SI
Bizcocho esponjoso sin grasa (8.5.1)		4	parilla	150	30-40	SI
Bizcocho esponjoso sin grasa (8.5.1)		2 + 5	bandeja 45 mm + parilla	150	30-40	SI
Bizcocho esponjoso sin grasa (8.5.1)		3	parilla	150	30-40	SI
Bizcocho esponjoso sin grasa (8.5.1)		2 + 5	bandeja 45 mm + parilla	150	30-40	SI
Tarta de manzana (8.5.2)		1	parilla	170	90-120	SI
Tarta de manzana (8.5.2)		1	parilla	170	90-120	SI
Tarta de manzana (8.5.2)		3	parilla	180	90-120	SI
Superficie de gratinado (9.2.2)		5	parilla	275	3-6	SI

* según modelo

NOTA : Para cocinar sobre 2 niveles, se puede salir los platos a diferentes momentos.



TABLA DE FUNCIONES COMBINADAS AUTOMÁTICAS CON LA ASOCIACIÓN DE VAPOR

Posición de la función	Display in Programador	Alimentos	Cantidad de agua para agregar
	□□	Pollo	500 ml de agua tibia en la bandeja multiusos
	□	Pato	500 ml de agua tibia en la bandeja multiusos
	□□□	Turquía	500 ml de agua tibia en la bandeja multiusos
	0	Pintade	800 ml de agua tibia en la bandeja multiusos
	□□□	Pescado entero (grande)	500 ml de agua tibia en la bandeja multiusos
	□□□□	Pescado entero (plano)	300 ml de agua tibia en la bandeja multiusos
	□□	Pescado entero pequeño	300 ml de agua tibia en la bandeja multiusos
	0000	Filetes de pescado	300 ml de agua tibia en la bandeja multiusos
	□□□		500 ml de agua tibia en la bandeja multiusos
	□□		500 ml de agua tibia en la bandeja multiusos

IMPORTANTE

Inserte la bandeja multiusos (con agua tibia) en el estante inferior, nivel 1 y sus alimentos para cocinar en el estante nivel 3.

FR

CS

DA

DE

EL

EN

ES

FI

IT

NL

NO

PL

PT

SK

SV

Brandt



KÄYTTÄJÄN OHJEET FI

UUNI

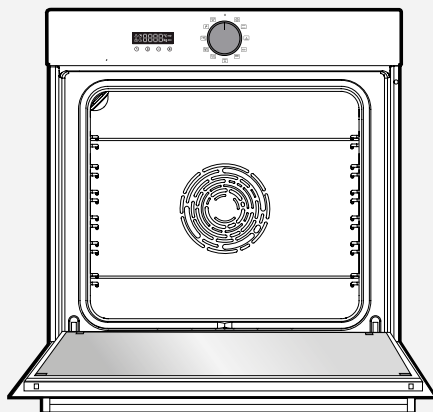

ORIGINE
FRANCE[®]
GARANTIE

BYCert.6011825

Hyvä asiakas,

Olet juuri ostanut **BRANDT**-tuotteen ja kiitämme luottamuksestasi meihin. Olemme suunnitelleet ja valmistaneet tämän tuotteen kanssasi, elämäntapasi ja tarpeesi huomioon ottaen, jotta se vastaa parhaiten odotuksiasi. Olemme panneet osaamisemme, innovaatiomme ja kaiken intohimomme, joka on ajanut meitä yli 60 vuoden ajan. Kuluttajapalvelumme on käytettävissä ja käytettävissä ja pyrimme vastaamaan kaikkiin kysymyksiisi tai ehdotuksiisi jatkuvasti vastaamaan vaatimuksiisi paremmin. Kirjautu myös verkkosivustollemme **www.brandt.com**, josta löydät uusimmat innovaatiomme sekä hyödyllistä ja lisätietoa.

BRANDT tukee mielellään päivittäin ja toivoo sinun nauttivan ostoksestasi täysin.



"Origine France Garantie" -merkki tarjoaa kuluttajille tuotteen jäljitettävyyden antamalla selkeän ja puolueettoman alkuperämerkinnän. BRANDT-tuotemerkki on ylpeä voidessaan kiinnittää tämän merkinnän Orléansissa ja Vendômessa sijaitsevien ranskalaisten tehtaidemme tuotteisiin.

<https://brandt.fr/>

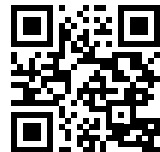

Tärkeä:

Ennen kuin käynnistät laitteen, lue tämä opas huolellisesti tutustuaksesi sen toimintaan nopeammin.



Turvaohjeet	4
YMPÄRISTÖ JA ENERGIANSÄÄSTÖ	6
Ympäristö	6
Energiansäästövinkki	6
Laitteen asentaminen	7
Sijainnin ja asennuksen valinta	7
Sähköliitäntä	8
Laitteen kuvaus	9
Näyttö ja ohjauspainikkeet	9
Lisävarusteet	10
Laitteen käyttäminen	12
Asetukset	12
Asetukset-valikko	13
Keittotilat	14
Keittämisen aloittaminen	15
Laitteen hoito	17
Sisätilojen - ulkopintojen puhdistus	18
Poikkeamat ja ratkaisut	19
Myynnin jälkeinen palvelu	21
Toimenpiteet	21
RUOKAUSTUET	21
Keittotaulukot	22
Reseptit hiivalla	24
Toiminnalliset kelpoisuustestit	25
Toiminnot automaattisella yhdistetyllä höyryllä	26



LUE TURVALLISUUSOHJEET HUOLELLISESTI JA SÄILYTÄ NE TU- LEVIA TARPEITA VARTEN.

Nämä ohjeet ovat ladattavissa valmistajan internetsivuilta.

- Vastaanottaessasi laitteen, pura pakkaus tai huolehdi pakkauksen purkamisesta välittömästi. Tarkista laite päällisin puolin. Tee mahdolliset huomautukset kirjallisesti lähetystositteeseen ja säilytä itselläsi kopio.
-
- Tärkeää:
 - Tämä laite soveltuu lasten käyttöön 8-vuotiaasta alkaen ja alentuneen fyysisen, aisteja koskevan tai henkisen toimintakyvyn omaavien henkilöiden käyttöön siten, että jos käyttäjillä ei ole tarvittavaa kokemusta tai tietoa laitteen käytöstä, heitä tulee opastaa etukäteen laitteen turvalliseen käyttöön ja siihen liittyviin mahdollisiin riskeihin ja heitä tulee valvoa käyttäessään laitetta.
 - — Älä anna lasten leikkiä laitteella. Älä anna lasten puhdistaa tai huoltaa laitetta ilman valvontaa.
 - — Valvo lapsia, etteivät he pääse leikkimään laitteen kanssa.
 -
 -
 - VAROITUS:
 - — Laite ja sen kosketeltavissa olevat osat kuumenevat käytön aikana. Varo koskettamasta uunin sisällä sijaitsevia kuumia osia. Alle 8-vuotiaat lapset on hyvä pitää etäällä laitteesta, ja laitteen lähellä ollessaan heitä on valvottava jatkuvasti.
 - — Tämä laite on suunniteltu ruuan valmistukseen luukun ollessa kiinni.
 - — Poista kaikki lisävarusteet ja isommat roiskeet ennen uunin pyrolyysipuhdistusta.
 - — Puhdistuksen aikana pinnat voivat kuumentua enemmän kuin normaalikäytössä.
 - Suosittelemme lasten pitämistä loitolla.
 - — Älä käytä höyrypuhdistuslaitetta.
 - — Älä käytä laitteen lasioven puhdistamiseen hankaavia tuotteita tai kovaa metallikaavinta, sillä nämä voivat naarmuttaa pintaa ja rikkoa lasin.
 -
 - VAROITUS:
 - Varmista ennen lampun vaihtamista sähköiskun ehkäisemiseksi, että laite on irrotettu virransyötöstä. Suorita toimenpide laitteen jäähdyttyä. Käytä kumikäsineitä lampun suojalasin irrottamiseen.
 -
 - Pistorasian tulee olla saavutettavissa asennuksen jälkeen. Laitteen



erottaminen virransyötöstä tulisi olla mahdollista joko irrottamalla pistoke pistorasiasta tai asentamalla virtakatkaisin kiinteään putkijohtoon asennusohjeiden mukaisesti.

-
- — Jos virtajohto on vioittunut, sen vaihtaminen on turvallisuus- syistä annettava valmistajan, tämän huoltopalvelun tai jonkun muun vastaavan ammattitaidon omaavan henkilön tehtäväksi.
- — Tämä laite voidaan asentaa työtason alle tai kalusteisiin asennuskaavion mukaisesti.
- — Keskitä uuni kalusteisiin siten, että sen ja vieressä olevan kalusteen väliin jää vähintään 10 mm:n väli. Upotettaessa uuni kalusteisiin näiden materiaalin tulee kestää kuumuutta (tai ne on päällystettävä tällaisessa materiaa- lilla). Asennuksen tukevuuden parantamiseksi uuni voidaan kiinnittää kalusteisiin 2 ruuvilla sen sivutuissa olevien reikien kautta.
- — Laitetta ei saa asentaa koristeoven taakse ylikuumene- misen ehkäisemiseksi.
- — Tämä laite on tarkoitettu koti- käyttöön tai sitä vastaavaan, kuten tavaratalojen henkilöstöti- lojen keittiönurkkauksiin, toimis- toihin ja muille vastaaville työpai- koille; maatiloille; hotellivieraiden käyttöön, motelleihin ja muihin

asuin- ja majoitustiloihin.

- — Uuni on sammutettava kaikkia uunin sisään kohdistuvia puhdis- tustoimia varten.
-
- Älä tee muutoksia laitteen omi- naisuuksiin, sillä tällainen toiminta on riskialtista.
-
- Älä käytä uunia käytön jälkeen ruuan tai tavaroiden säilytyspai- kana.
-



Ympäristö

Tämän laitteen pakkausmateriaalit ovat kierrätettäviä. Osallistu niiden kierrätykseen ja auta siten suojelemaan ympäristöä asettamalla ne kunnallisiin astioihin tätä tarkoitusta varten.

Laite sisältää myös monia kierrätettäviä materiaaleja. Siksi se on merkitty tällä logolla osoittamaan sinulle, että käytettyjä laitteita ei tule sekoittaa muihin jätteisiin.



Valmistajan järjestämä laitteiden kierrätys tapahtuu siten parhaissa olosuhteissa voimassa olevan sähkö- ja elektroniikkalaiteromun mukaisesti.

Ota yhteyttä kaupungintaloon tai jälleenmyyjään saadaksesi kotiisi lähimpänä olevien käytettyjen laitteiden keräyspisteet.

Kiitämme yhteistyöstäsi ympäristön suojelussa.

Energiansäästövinkki

Pidä uunin luukku kypsennyksen aikana kiinni.



SIJAINNIN JA ASENNUKSEN VALINTA

Kaaviot määrittävät uuniin sopivan huonekalun mitat. Tämä laite voidaan asentaa joko pylvääseen (A) tai tiskiin (B) alle. Jos kaappi on auki, sen aukon on oltava takana enintään 70 mm (C ja D). Kiinnitä uuni kaappiin. Poista tällöin kumitulpat ja poraa esikaapin seinään \varnothing 2 mm: n reikä, jotta puu ei halkeile. Kiinnitä uuni kahdella ruuvilla.

Vaihda kumitulpat.



Neuvo:

Varmista, että sinulla on vaatimustenmukainen asennus, älä epäröi kutsua laitteen asiantuntijaa.



Varoitus:

Jos kodin sähköasennusta on muutettava laitteen liittämiseksi, ota yhteys pätevään sähköasentajaan. Jos uunissa on poikkeavuuksia, irrota laite tai poista uunin liittäjäjohtoa vastaava sulake.

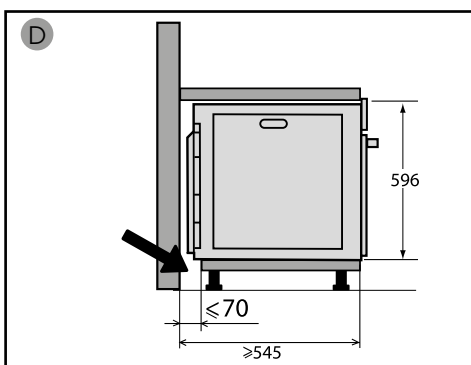
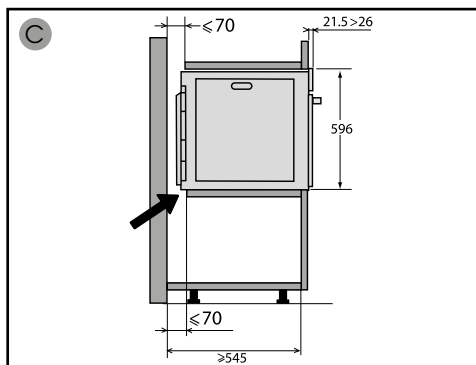
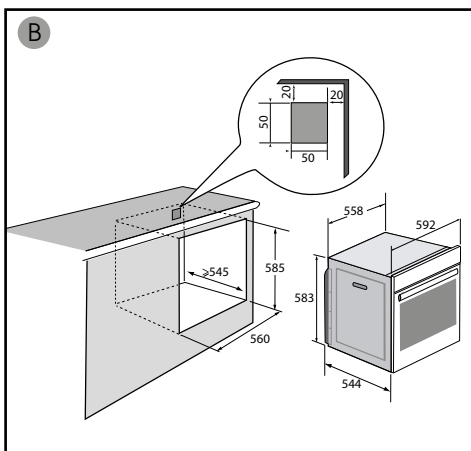
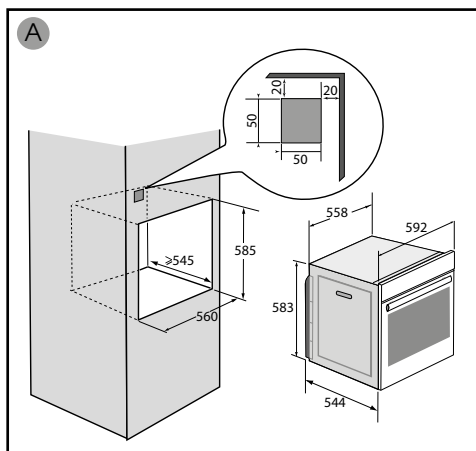



SÄHKÖLIITÄNTÄ

Uuni on kytkettävä tavallisella virtajohdolla, jossa on 3 1,5 mm² johtinta (1 ph + 1 N + maadoitus), joka on kytkettävä 220 ~ 240 voltin verkkoon pistortasian kautta. asennusohjeet.



Varoitus

Suojajohto (vihreä-keltainen) on kytketty laitteen liittimeen ja se on kytkettävä asennuksen maahan. Asennuslakkien on oltava 16 ampeeria.

Meitä ei voida pitää vastuussa onnettomuuksista tai vaaratilanteista, jotka johtuvat olemattomasta, viallisesta tai väärästä maadoituksesta, tai väärän yhteyden takia.

• Ennen ensimmäistä käyttöä

Ennen kuin käytät uunia ensimmäistä kertaa, lämmitä sitä tyhjänä, luukku suljettuna, noin 15 minuuttia korkeimmassa lämpötilassa. murtumaan laitteeseen. Mineraalivilla, joka ympäröi uunin ontelo, voi aluksi antaa erityisen hajun koostumuksestaan johtuen. Samoin saatat huomata savua. Kaikki tämä on normaalia.

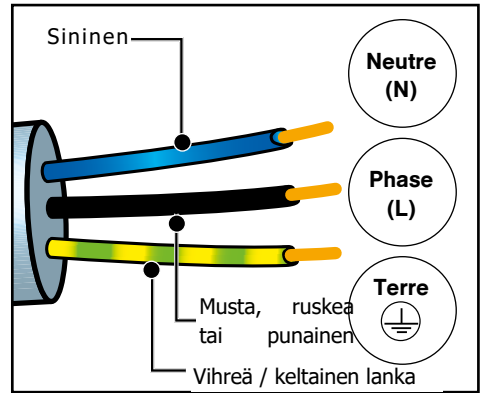



Uunin yleiskuvaus

UUNIN YLEISKUVAUS

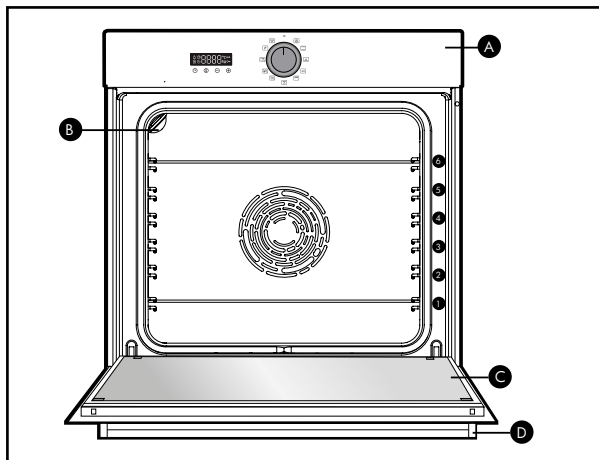

A Ohjauspaneeli

B Valo

C Luukku

D Kädensija

Tässä uunissa on 6 peltitasoasentoa lisävarusteille: peltitasot 1 - 6.

• NÄYTTÖ



- Kokkaus aika
- Keittämisen loppu
- Näppäimistön lukitus
- Ajastin
- Lämpötilan ilmaisin
- Esilämmityksen ilmaisin
- Lukko

• PAINIKKEET

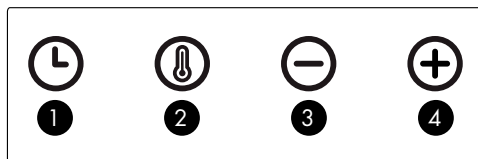

- 1** Kellon ja kestoajan asetukset
- 2** Lämpötilan asetukset
- 3** Painike -
- 4** Painike +



TARVIKKEET

• Kaatumisen estävä turvaritilä

Ritilää voi käyttää paistettavien tai gratinoitavien ruoka-astioiden tai vuokien alustana. Sitä voidaan käyttää grillaamiseen (ruoka-ainekset asetetaan ritilän päälle)

Aseta ritilän kahva uunin takaosaa vasten.

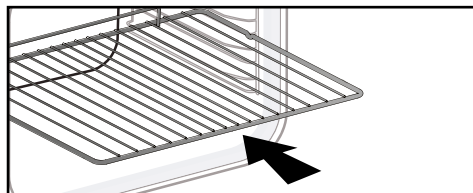

• Syvä monikäyttöpeltili 45mm

Asennus peltitasolle ripa kohti uunin luukkua. Pelti kerää grillattavista ruuista tippuvan rasvan, sitä voidaan käyttää puoliksi vedellä täytettynä vesihaudekypsennykseen.

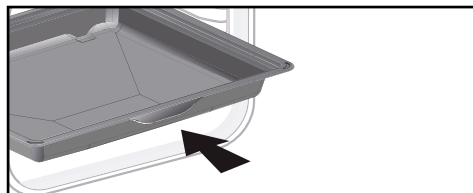

• Paistopelti 20mm

Asennus peltitasolle ripa kohti uunin luukkua. Sopii keksien, murokeksien ja kuppikakkujen paistamiseen. Kallistettu laita helpottaa leivonnaisten asettamista pellille. Peltiä voi myös käyttää peltitasolla grilliritilän alla keräämään grilliruusta tippuvaa rasvaa.

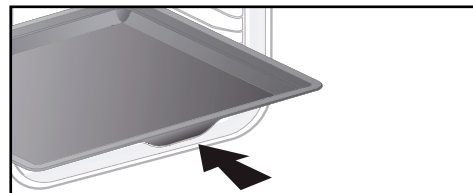

• Liukukiskojärjestelmä

Liukukiskojärjestelmän ansiosta ruokien käsittely on käytännöllistä ja helppoa. Pellit voi vetää yksinkertaista. Pellit voi myös irrottaa kokonaan, jolloin niihin pääsee helposti käsiksi.

Pellit ovat lisäksi vakaita, mistä johtuen ruokien työstäminen ja käsittely on turvallista. Tämä vähentää myös palovammojen riskiä, Ruuat on todella helppo ottaa pois uunista.

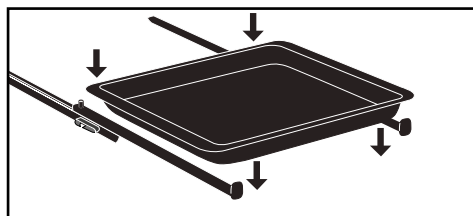

Varoitus:

Poista tarvikkeet ja hyllyt uunista ennen pyrolyysipuhdistuksen aloittamista.

Varoitus:

Lämmön vaikutuksesta lisävarusteet voivat deformatua vaikuttamatta niiden toimintaan. Ne palaavat alkuperäiseen muotoonsa jäähtyessään.



LIUKUKISKOJEN ASENTAMINEN JA IRROTTAMINEN

Vedä ensin ulos 2 kiskoja, valitse sitten peltitaso (2 - 5), jolle haluat asentaa liukukiskot. Kiinnitä vasen kisko vasemmanpuoleiseen ristikkoon painamalla sen etuosaa ja takaosaa siten, että liukukiskon 2 uloketta asettuvat ristikon sisään. Menettele samalla tavalla oikeanpuoleisen liukukiskon kanssa.

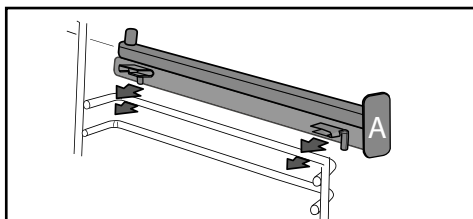

HUOMAA: liukukiskon teleskooppiosa tulee ojentua uunin etuosaa kohti ja sen pää tulee kohti asentajaa.

Aseta 2 ristikköä paikalleen ja aseta sitten pelti 2 kiskolle. Järjestelmä on nyt valmis käyttöön.

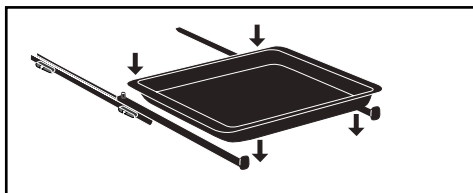

Liukukiskojen irrottamiseksi irrota jälleen ristikot.

Paina ulokkeita ristikon läpi taaksepäin niiden irrottamiseksi ristikosta. Vedä liukukisko irti itseäsi kohti.

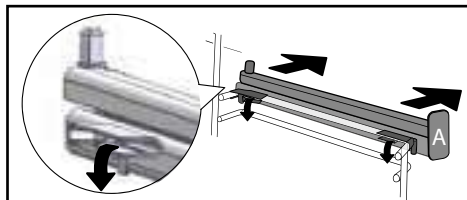

Vinkki

Vältäaksesi rasvaisista lihoista syntyvän savun muodostumista paistamisen aikana suosittelemme laittamaan pienen määrän vettä tai öljyä syvän paistopellin pohjalle.



ASETUKSET

• Kellon asetukset

Kun virta kytketään uuniin näytössä vilkkuu 12:00.

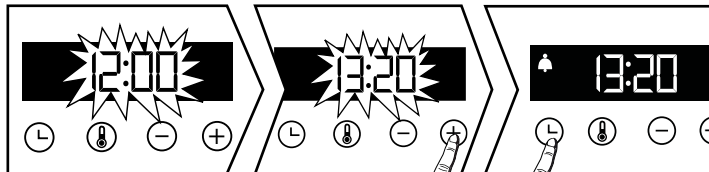



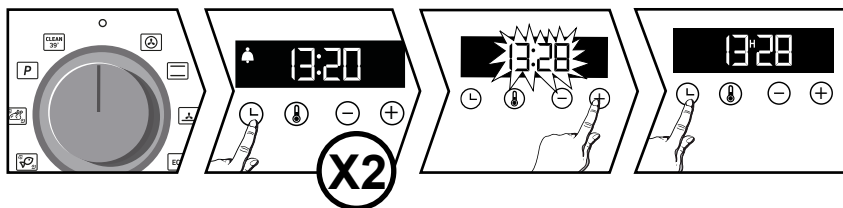

Aseta kellonaika painikkeilla + tai -. Vahvasta painikkeella  . Sähkökatkon jälkeen kellonaika vilkkuu.

• Kellonajan muuttaminen

Toiminnon valitsimen on oltava asennossa 0.





Paina painiketta  symboli  ilmestyy  . paina uudelleen painiketta  . Aseta kellonaika painikkeilla + tai - .

• Munakello

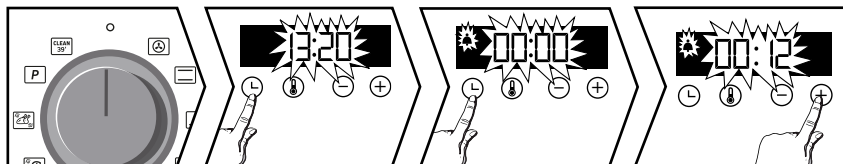
Tämä toiminto on käytettävissä vain uunin ollessa pois toiminnasta.



Toiminnon valitsimen on oltava asennossa 0.



Paina painiketta  symboli  ilmestyy. Aseta kellonaika painikkeilla + tai - Vahvasta painikkeella  .

HUOMIO: Ajastintointoa voi muuttaa tai sen voi peruuttaa milloin tahansa. Munakellotoiminto peruutetaan siirtymällä munakellovalikkoon ja asettamalla ajaksi 00:00 ilman vahvistamista, jolloin asetus otetaan automaattisesti käyttöön muutaman sekunnin kuluttua.

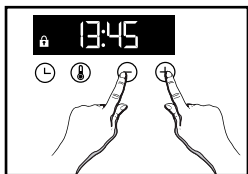

• KÄYTTÖPANEELIN LUKITUS



Paina samanaikaisesti painikkeita + ja - kunnes symboli  à l'écran. ilmestyy näyttöön. Ottaaksesi ohjauspainikkeet  jälleen käyttöön paina samanaikaisesti painikkeita + ja - kunnes symboli häviää näytöltä.

ASETUKSET-VALIKKO

Voit puuttua uunin eri parametreihin seuraavasti: Paina näppäintä, kunnes "MENU" tulee näyttöön päästäksesi asetustilaan.

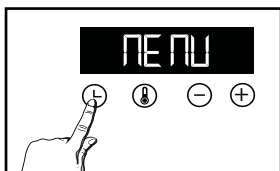

Paina painiketta uudelleen  vierittääksesi eri asetuksia.

Aktivoi tai deaktivoi eri parametrit + ja - näppäimillä, katso alla oleva taulukko:

	AUTO: Keittotilassa ontelovalaisin sammuu 90 sekunnin kuluttua PÄÄLLÄ: Keittotilassa lamppu palaa aina.
	Aktivoi / deaktivoi näppäinäenät
	Aktivoi / deaktivoi esilämmitystila
	Aktivoi / deaktivoi esittelytila

Poistu "MENU" -valikosta painamalla uudelleen .



Kypsennys

UUNITOIMINNOT

Manuaaliset toiminnot:



KIERTOILMA*

Minimilämpötila 35°C maksimilämpötila 250°C
Suositellaan valkoisen lihan, kalan ja vihannesten pehmeuden säilyttämiseen. Valmistettaessa ruokaa useilla tasoilla, jopa 3 kerroksessa.



PERINTEINEN

Minimilämpötila 35°C maksimilämpötila 275°C
Suositellaan hitaaseen ja monimutkaiseen kypsennykseen: pehmeälihaiseen riistaan. Punaisen lihan paistien ruskistamiseen. Keittolevyllä aluksi valmisteltujen ruokalajien haudutus suljetussa astiassa (coq au vin, pataruoat).



ALALÄMPÖ KIERTO

Minimilämpötila 75°C maksimilämpötila 250°C
Suositellaan kosteille ruokalajeille (piiraat, mehevät hedelmäpiirakat...). Taikinapohja paistuu hyvin. Suositellaan kohoaville leivonnaisille (kakku, pulla, kuivakakku...) ja kohokkaille ilman taikinakuorta.



EKO*

Minimilämpötila 35°C maksimilämpötila 275°C
Tämä asetus auttaa säästämään energiaa ja samalla säilyttämään kypsennyksen hyvät puolet. Kaikki kypsennykset tehdään ilman esilämmitystä.



VOIMAKAS GRILLI MEDIUMGRILLI

Minimilämpötila 180°C maksimilämpötila 275°C
Suositellaan paahdotelepien grillaamiseen, ruokalajien gratinoimiseen, crème brûléeen ruskettamiseen...



GRILLI KIERTO

Minimilämpötila 100°C maksimilämpötila 250°C
Linnunliha liha ja mehevät tai rapeat paistit kaikilla liesitasoilla.

Aseta syvä paistopelti alimmalle peltitasolle. Suositellaan linnunliha lihalle ja paisteille, paistin ruskistamiseksi ja kypsennykseen sekä naudan kyljyksille. Kalasta valuvan rasvan keräämiseen pellille.

Automaattiset toiminnot:

Brandt tarjoaa 3 uutta toimintoa, jotka yhdistävät automaattisesti kaksi kypsennystilaa: perinteisen kypsennyksen ja höyrytyskeiton ruoan ravitsemuksellisten ominaisuuksien säilyttämiseksi ja nopeamman kypsennyksen saamiseksi.



VALKOINEN LIHA

Suosittelaaan sian- ja vasikanpaistien pehmeuden ja lempeyden säilyttämiseksi.



KALAT

Suosittelaaan kokojen tai fileiden kypsennykseen.



SIIPIKARJA

Suosittelaaan kanojen, kalkkunoiden, helmikanojen ja ankkujen keittämiseen. Näitä 3 toimintoa varten sinun tarvitsee vain lisätä astiaan (tiputusastiaan) riittävästi haaleaa vettä ja laittaa se uuniin alemmalle hyllylle ja ruoat kypsennettäväksi tasolla 3.

Katso tippa-astiaan asetettavan veden määrä ohjeiden lopussa olevasta taulukosta automaattisista yhdistetyistä toiminnoista, joissa yhdistetään höyryä.



"Smart Assist" -järjestelmä

Uunissasi on "Smart Assist" -toiminto, joka suosittelee ohjelmoitavaa kestoa ohjelmoitun keston mukaan valitun kypsennystavan mukaan.

** Valmistusmenetelmä suoritettu standardin EN 60350-1: 2016 vaatimusten mukaisesti, jotta voidaan osoittaa EU-asetuksen EU / 65/2014 energiamerkintöjä koskevien vaatimusten noudattaminen.*



Kypsennys

• Välittömän ruoanlaiton aloittaminen

Ohjelmoijan tulisi näyttää vain aika. Tämän ei pitäisi vilkkua.

Käännä toimintovalitsin haluamaasi asentoon.

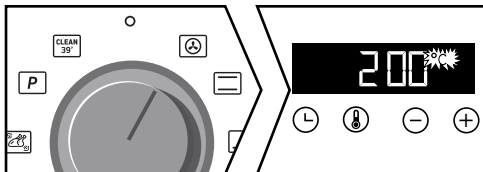



Manuaaliset toiminnot:

Lämpötilan nousu alkaa heti. Uuni suosittelee lämpötilaa, jota voidaan muuttaa. Uuni lämpenee ja lämpötilan osoitin vilkkuu. Merkkiäni kuuluu, kun uuni saavuttaa asetetun lämpötilan.

Automaattiset toiminnot:

 tulee näyttöön.

Valitse ruokasi pakkausselosteen lopusta olevasta taulukosta. Paina + ja - näppäimiä, kunnes näyttöön tulee haluttu kaavio, vahvista sitten näppäimellä .

Paino vilkkuu; syötä ruokasi todellinen paino + ja - näppäimillä ja vahvista sitten .

Sinun ei tarvitse asettaa mitään muuta, lämpötila ja kypsennysaika lasketaan automaattisesti.

Kypsennysajan loppu vilkkuu, vahvista näppäimellä .Ruoanlaitto alkaa heti.

• Lämpötilan muutos

paina .

Säädä lämpötila + tai - avulla. Vahvista painamalla .

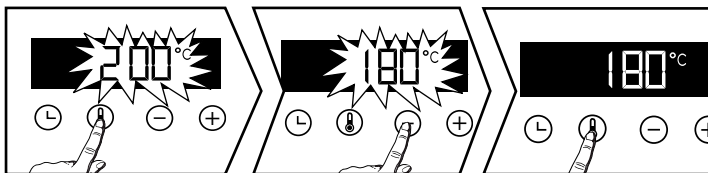

• Keston muuttaminen

Kypsennä heti ja paina sitten ,kypsennysaika  vilkkuu, asetus on mahdollista. Aseta kypsennysaika painamalla + tai -.

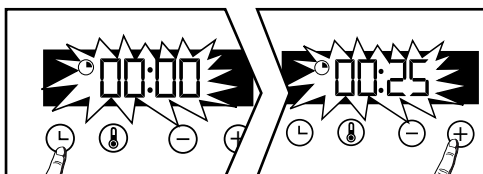



"Smart Assist" -järjestelmä
Uunissasi on "Smart Assist" -toiminto, joka suosittelee kestoja ohjelmoitaessa muokattavaa kypsennysaikaa valitun kypsennystavan mukaan (katso taulukko).

Kypsennysaika tallennetaan automaattisesti muutaman sekunnin kuluttua. Aika lasketaan heti, kun kypsennyslämpötila on saavutettu.

KEITTOTOIMINTO	KESTO
	30 min
	30 min
	30 min
	30 min
	7 min
	15 min

• Kypsennysajan muuttaminen

Jatka ohjelmoituna kestonäytteenä. Kun olet asettanut kypsennysajan, paina painiketta. ⌚, kypsennysajan loppu ☺.

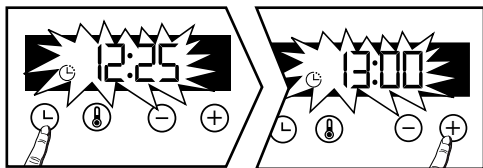

Näyttö vilkkuu, aseta kypsennysajan loppu painikkeilla + tai -.

Kypsennyksen loppu tallennetaan automaattisesti muutaman sekunnin kuluttua. Kypsennyksen lopetusnäyttö ei enää vilku.



SISUSTUS - ULKOPINTOJEN PUHDISTUS

• Ontelon puhdistus pyrolyysillä



Varoitus

Poista lisävarusteet ja vajerihyllyt uunista ennen pyrolyysipuhdistuksen aloittamista. Ennen kuin aloitat uunin pyrolyysipuhdistuksen, poista kaikki mahdolliset ylivuotot. Poista ylimääräinen rasva ovesta kostealla sienellä.

Turvallisuussyistä pyrolyysin puhdistus suoritetaan vasta sen jälkeen, kun ovi on automaattisesti lukittu, oven avaaminen on mahdotonta.

• Välitön itsepuhdistus

Ohjelmoijan tulisi näyttää kellonaika vilkkumatta. Valitse toimintopainikkeella yksi itsepuhdistussykleistä  tai  :

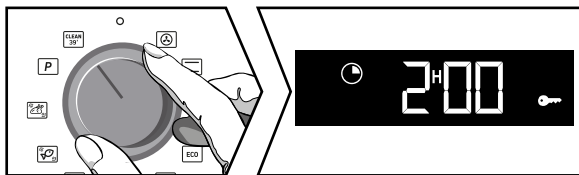



 = Siivous 39 minuutissa

- "Clean 39" vierittää ruudun kypsennyksen molemmissa päissä ja tarjoaa sinulle mahdollisuuden aloittaa puhdistus. Aseta varsi tälle toiminnolle ja vahvasta näppäimellä . Kesto 0:39 näytetään vuorotellen "Clean 39": n kanssa, puhdistus alkaa. Muutaman minuutin kuluttua avain ilmestyy, uunin luukku lukittuu automaattisesti turvallisuuden vuoksi koko ohjelman ajan.

Jos haluat käyttää "Clean 39" -uunia, joka on kylmä tai ei tarpeeksi kuuma, ohjelman käynnistysolosuhteet eivät salli tätä puhdistusta. 0:00 ilmestyy näytölle, sinun on sitten valittava toinen itsepuhdistuva asento .



 = 2 tunnin. Aseta vipu tähän toimintoon.

Aseta vipu tähän toimintoon.  tulee näyttöön. Paina + valitaksesi pyrolyysi uunisi likaantumisasteen mukaan.

Valinnan mukaan näytössä näkyy kesto 2:00. Vahvasta näppäimellä .  näytetään,, pyrolyysi alkaa. Puhdistuksen lopussa näytössä näkyy 0:00 ja luukku avautuu.

Palauta toimintovalitsin asentoon 0.

• Lykätty itsepuhdistus

Sinulla on mahdollisuus lykätä Pyrolyysin alkua. Kun ohjelman kesto näkyy näytöllä, paina painiketta  ja aseta uusi lopetusaike + ja - näppäimillä ja vahvasta sitten painikkeilla . Itsepuhdistus alkaa myöhemmin ja päättyy uutena aikataulun mukaan. Palauta toimintovalitsin asentoon 0 puhdistuksen lopussa.



• Ulkopinnan puhdistaminen

Käytä ikkunanpuhdistusaineeseen kastettua pehmeää liinaa. Älä käytä hankausvoiteita tai kaavinsientä.

• Johtotelineiden puhdistus

Pura vaihejohdot niiden puhdistamiseksi. Nosta askelman etuosa ylös; työnnä koko askel ylöspäin ja vapauta etukoukku kotelostaan. Vedä sitten koko askelta hieman itseäsi kohti vapauttaaksesi takakoukut kotelostaan. Poista 2 vaihetta.

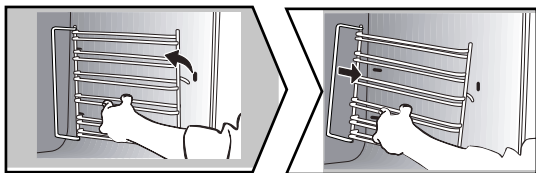

• Oven lasin puhdistus



Varoitus :

Älä käytä hankauspuhdistusaineita, hankaussientä tai metallikaavioita uunin lasin luukun puhdistamiseen, sillä ne voivat naarmuttaa pintaa ja saada lasin rikkoutumaan.

Poista ensin ylimääräinen rasva sisäpaneelistä pehmeällä liinalla ja pesuaineella. Puhdista erilaiset sisäpaneelit purkamalla ne seuraavasti:

• Oven lasin puhdistus

Avaa luukku kokonaan ja lukitse se laitteen muovipussissa olevalla muovikiilalla.

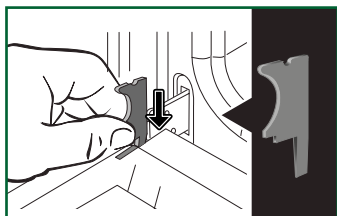

Poista ensimmäinen leikattu ruutu: paina työkalua (ruuvimeisseliä) paikoissa (A), jotta voit purkaa paneelin.



Tärkeä:

Varmista, että merkitsit tämän ensimmäisen ikkunan asennussuunnan (kiiltävä puoli itseäsi kohti)



Ovi koostuu mallista riippuen kahdesta ylimääräisestä ruudusta, joissa kummassakin kulmassa on musta kumilevy. Poista tarvittaessa ne puhdistusta varten.

Älä upota ikkunoita veteen. Huuhtelee puhtaalla vedellä ja pyyhi kuivaksi nukkaamattomalla liinalla.

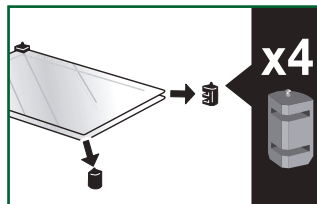
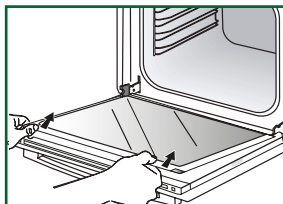
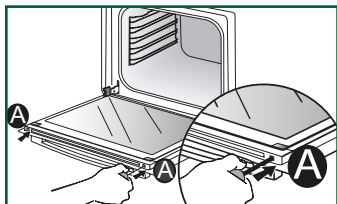

• Oviikkunoiden asentaminen

Puhdistuksen jälkeen aseta neljä ylöspäin osoittavan nuolen kumitulppaa uudelleen ja aseta lasikokoonpano uudelleen.

Kiinnitä viimeinen ruutu metallitukiin, kiinnitä sitten kiiltävä puoli itseäsi kohti ja poista muovikiila.

Laitte on jälleen toiminnassa.

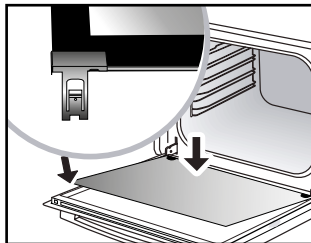
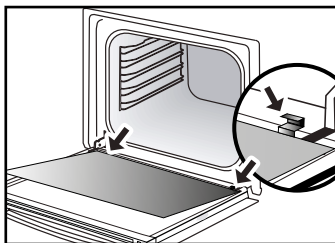
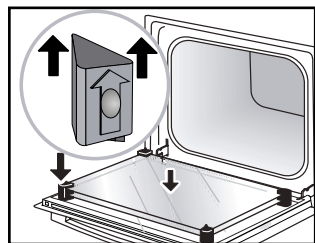

• Lampun vaihtaminen



Varoitus:

Varmista ennen valon vaihtamista sähköiskun ehkäisemiseksi, että laite on irrotettu virransyötöstä. Suorita toimenpide laitteen jäähtyttyä.

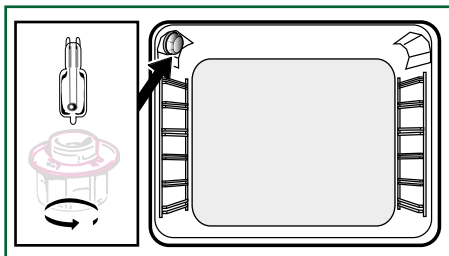

Lampun tyyppi:

25 W, 220-240 V~, 300°C, kanta G9.

Käytä kumikäsinettä lampun suojalasin irrottamiseen.



POIKKEAMAT JA RATKAISUT

Uuni ei lämpene.

Tarkista uunin virtakytkentä ja että uunia ei ole kytketty irti sulakkeesta. Suurena valittua lämpötilaa.

Uunin valo ei toimi.

Vaihda lamppu tai polttimo. Tarkista uunin virtakytkennät.

Uunin jäädytyspuhallin jatkaa toimintaansa uunin sammuttamisen jälkeen.

Tämä on normaalia. Jäädytyspuhallin voi toimia jopa enintään 1 tunnin ajan kypsentämisen jälkeen uunin sisä- ja ulkopuolella olevan lämpötilan laskemiseksi. Jos puhallin toimii yli tunnin ajan, ota yhteys huoltopalveluun.

Pyrolyysipuhdistus ei toimi.

Tarkista, että luukku on kiinni. Luukun lukituksessa tai lämpötila-anturissa on häiriö. Ota yhteys huoltopalveluun.

Symboliviilkkuu näytöllä.

Luukun lukituksen vika, ota yhteys huoltopalveluun.

Värisevä melu.

Tarkista, että virtajohto ei ole kosketuksessa taakaseinän kanssa.

Tällä ei ole vaikutusta laitteen oikeaan toimintaan, mutta se voi silti aiheuttaa tärisevää melua ilmanvaihdon aikana. Irrota laite ja siirrä johtoa. Vaihda uuni.



Myynnin jälkeinen palvelu

KORJAUSTOIMET

Laitteen mahdolliset korjaustoimet on annettava valmistajan valtuuttaman ammattihenkilön suoritettaviksi. Voidaksemme vastata paremmin kyselyihinne koskien laitettanne varautukaa esittämään kaikki laitettanne koskevat tiedot (tuotenumero, huoltotiedot ja sarjanumero). Nämä tiedot löytyvät tuotteen tyyppikilvestä.

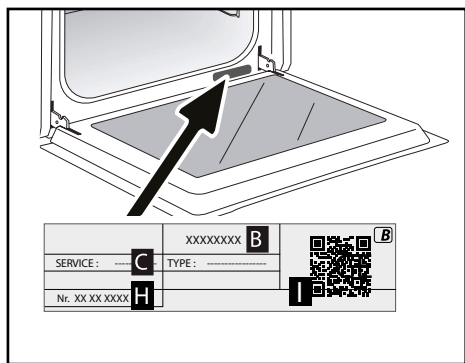

B : Tuotenumero
C : Huoltotiedot
H : Sarjanumero

ALKUPERÄISET OSAT

Huoltokäsittelyn aikana pyydä käyttämään vain alkuperäisiä sertifioituja varaosia.





RUOKALAJIT	* * * * * * *												min
Liharuoat													
Porsaanpaisti (1 kg)	200	2					180	2					60
Vasikanpaisti (1 kg)	200	2					180	2					60-70
Naudanpaisti	240	2											30-40
Lammas (reisi, lapa 2,5 kg)	220	1.			220					200	2		60
Linnunliha (1 kg)	200	2			220		180	2			210	3	60
Linnunliha, suurikokoinen	180	1.											60-90
Kanankoipi					220	3					210	3	20-30
Porsaan- tai vasikankyljykset					210	3							20-30
Naudankyljykset (1 kg)					210	3					210	3	20-30
Lampaankyljykset					210	3							20-30
KALA													
Grillattu kala					275	4							15-20
Paistettu kala	200	3					180	3					30-35
Kala en papillote	220	3					200	3					15-20
Vihannekset													
Gratiinit					275	2							30
Perunagratiini	200	2					180	2					45
Lasagne	200	3					180	3					45
Täytetyt tomaatit	170	3					160	2					30
Leivonnaiset													
Savoiard- ja Génoisekeksit			180	2							180	2	35
Kääretorttu	220	3									180	2	5-10
Pulla	180	1.	210								180	2	35-45
Pikkuleivät	180	2					175	3					20-25
Hiekkakakut	180	1.	180	1.							180	2	45-50
Hedelmäpiiras	200	2					180	3					30-35
Vanukkaat	165	2									150	2	30-40

* (mallista riippuen)



RUOKALAJIT	* * * * * * *														min
Leivonnaiset															
Madeleine-leivokset	220	3						200	3						5-10
Tuulihatut	200	3					180	3					180	3	30-40
Petit fours -leivokset	220	3					200	3							5-10
Savariini	180	3											175	3	30-35
Murotaikinaleivät	200	1.					195	1.							30-40
Hedelmäpiirakat	215	1.					200	1.							20-25
Hiivataikinapiirakat	210	1.					200	1.							10-30
Sekalaiset															
Vartaat	220	3			210	4									10-15
Lihamureke	200	2					190	2							80-100
Pitsa murotaikina	200	2													30-40
Pitsa leipätaikina															15-18
Piiraat															35-40
Kohokkaat													180	2	50
Tortut	200	2													40-45
Leipä	220						200	220							30-40
Paahdettu leipä	180				275	4-5									2-3
Suljetut astiat (pataruoat)	180	2											180	2	90-180

* (mallista riippuen)



Kaikki lämpötilat ja kypsennysajat on annettu esilämmitetyille uunille

HUOMAUTUS: Lihan on oltava huoneenlämmössä ainakin 1 tunnin ajan ennen uuniin laittamista.

VASTAAVUUS: ARVOT T °C

°C	30	60	90	120	150	180	210	240	275
ARVOT	1	2	3	4	5	6	7	8	9 max

Kaikki lämpötilat ja kypsennysajat on annettu esilämmitetyille uunille

HUOMAUTUS: Lihan on oltava huoneenlämmössä ainakin 1 tunnin ajan ennen uuniin laittamista.

Hiivaresepti (riippuen mallista)

Ainekset:

● Jauhoa 2 kg ● Vettä 1240 ml ● Suolaa 40 g ● 4 pakettia leivontaan tarkoitettua kuivahiivaa
Sekoita taikina mikserillä ja anna sen kohota uunissa.

Ohje: Hiivataikinaresepteille. Laita taikina uuninkestävässä astiassa lämpimään paikkaan, Irrota ristikot ja aseta pelti uunin pohjalle.

**Lämmitä uuni kiertoilmatoiminnalla viiden minuutin ajan 40-50 °C:seen.
Sammuta uuni ja anna taikinan nousta 25-30 minuutin ajan jälkilämmöllä.**

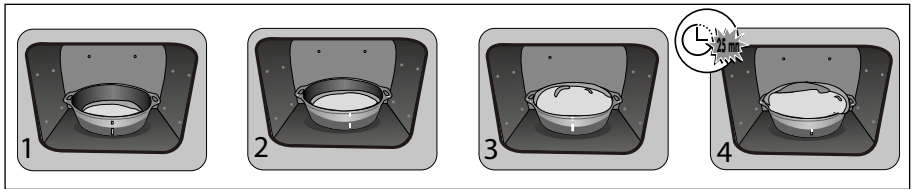



TOIMINTOJEN SOVELTUVUUSTESTIT STANDARDIN CEI 60350 MUKAISESTI













RUOKA-AINE	*Uunitoi- minto	TASO	Lisävarusteet	T °C	AIKA min.	ESILÄM- MITYS
Murokeksit (8.4.1)		5	pelti 45 mm	150	30-40	kyllä
Murokeksit (8.4.1)		5	pelti 45 mm	150	25-35	kyllä
Murokeksit (8.4.1)		2 + 5	pelti 45 mm + grilli	150	25-45	kyllä
Murokeksit (8.4.1)		3	pelti 45 mm	175	25-35	kyllä
Murokeksit (8.4.1)		2 + 5	pelti 45 mm + grilli	160	30-40	kyllä
Pikkukakut		5	pelti 45 mm	170	25-35	kyllä
Pikkukakut		5	pelti 45 mm	170	25-35	kyllä
Pikkukakut		2 + 5	pelti 45 mm + grilli	170	20-40	kyllä
Pikkukakut		3	pelti 45 mm	170	25-35	kyllä
Pikkukakut		2 + 5	pelti 45 mm + grilli	170	25-35	kyllä
Pehmeä kakku ilman rasvaa (8.5.1)		4	grilli	150	30-40	kyllä
Pehmeä kakku ilman rasvaa (8.5.1)		4	grilli	150	30-40	kyllä
Pehmeä kakku ilman rasvaa (8.5.1)		2 + 5	pelti 45 mm + grilli	150	30-40	kyllä
Pehmeä kakku ilman rasvaa (8.5.1)		3	grilli	150	30-40	kyllä
Pehmeä kakku ilman rasvaa (8.5.1)		2 + 5	pelti 45 mm + grilli	150	30-40	kyllä
Hedelmäpiirakka (8.5.2)		1.	grilli	170	90-120	kyllä
Hedelmäpiirakka (8.5.2)		1.	grilli	170	90-120	kyllä
Omenapiirakka (8.5.2)		3	grilli	180	90-120	kyllä
Gratinoitu pinta (9.2.2)		5	grilli	275	3-6	kyllä

* (mallista riippuen)

HUOMAUTUS: Paistettaessa kahdella tasolla pellit voi ottaa pois eri aikoihin.



TAULUKKO YHDISTETYT TOIMINNOT AUTOMAATTINEN HÖYRYN YHDISTÄMISEN KANSSA

Ohjaussauvan asento	Näyttö ohjelmoijalla	Ruoka	Lisättävän veden määrä
		Kana	500 ml haaleaa vettä tiputusastiassa
		Ankka	500 ml haaleaa vettä tiputusastiassa
		Turkki	500 ml haaleaa vettä tiputusastiassa
		Helmikana	800 ml haaleaa vettä tiputusastiassa
		Kokonainen kala (iso)	500 ml haaleaa vettä tiputusastiassa
		Kokonainen kala (tasainen)	300 ml haaleaa vettä tiputusastiassa
		Pienet kokonaiset kalat	300 ml haaleaa vettä tiputusastiassa
		Kalafileet	300 ml haaleaa vettä tiputusastiassa
		Paahdettua sianlihaa	500 ml haaleaa vettä tiputusastiassa
		Paahdettua vasikanlihaa	500 ml haaleaa vettä tiputusastiassa

TÄRKEÄ

Aseta tiputusastia (haalealla vedellä) alemmalle hyllylle, tasolle 1 ja kypsennettävä ruokasi tasolle 3.



- EN Information for domestic ovens (UE n° 662014)
- DE Informationen zu Haushaltsbacköfen (UE n° 662014)
- FR Informations concernant les fours domestiques (UE n° 662014)
- ES Información sobre los hornos domésticos (UE n° 662014)
- CS Informace týkající se trou pro domácnosti (UE n° 662014)
- SK Informácia týkajúca sa trou pro domácnosť (UE n° 662014)
- DA Oplysninger for ovne til husholdningsbrug (UE n° 662014)
- NL Informatie met betrekking tot huishoudelijke ovens (UE n° 662014)
- FI koteloitten uunien tiedot (UE n° 662014)

EN	DE	FR	ES	CS	SK	DA	NL	FI	Symbol	Value	Unit	EN Symbol	FR Symbol	ES Symbol	CS Symbol	SK Symbol	DA Symbol	NL Symbol	FI Symbol	
Information for domestic ovens (UE n° 662014)	Informationen zu Haushaltsbacköfen (UE n° 662014)	Informations concernant les fours domestiques (UE n° 662014)	Información sobre los hornos domésticos (UE n° 662014)	Informace týkající se trou pro domácnosti (UE n° 662014)	Informácia týkajúca sa trou pro domácnosť (UE n° 662014)	Oplysninger for ovne til husholdningsbrug (UE n° 662014)	Informatie met betrekking tot huishoudelijke ovens (UE n° 662014)	koteloitten uunien tiedot (UE n° 662014)	KCD2SP											
Type name									KCD2SP											
Models identification									KCD2SP											
Type of oven									KCD2SP											
Mass of the appliance	M	34,5	30,7	35,7	33,5	36,2	35,6	35,0	33,5	35,6	38,0	38,0	38,0	38,0	38,0	38,0	38,0	38,0	38,0	38,0
Number of cavities		1	1	1	1	1	1	1	1	1	1	1	1	1	1	1	1	1	1	1
Heat source per cavity (type of fuel or gas)	Electricity (gas)	FR: Electricité-Gaz Electricity (gas)	FR: Electricité-Gaz Electricity (gas)	FR: Electricité-Gaz Electricity (gas)	FR: Electricité-Gaz Electricity (gas)	FR: Electricité-Gaz Electricity (gas)	FR: Electricité-Gaz Electricity (gas)	FR: Electricité-Gaz Electricity (gas)	FR: Electricité-Gaz Electricity (gas)	FR: Electricité-Gaz Electricity (gas)	FR: Electricité-Gaz Electricity (gas)	FR: Electricité-Gaz Electricity (gas)	FR: Electricité-Gaz Electricity (gas)	FR: Electricité-Gaz Electricity (gas)	FR: Electricité-Gaz Electricity (gas)	FR: Electricité-Gaz Electricity (gas)	FR: Electricité-Gaz Electricity (gas)	FR: Electricité-Gaz Electricity (gas)	FR: Electricité-Gaz Electricity (gas)	FR: Electricité-Gaz Electricity (gas)
Volume per cavity	V	730	730	730	730	730	730	730	730	730	730	730	730	730	730	730	730	730	730	730
Energy consumption (mode per cavity) required to heat a standardized load in a heated oven during a cycle in fan-forced mode per cavity (electric final energy)	EC	0,82	0,82	0,89	0,79	0,79	0,79	0,79	0,79	0,79	0,79	0,79	0,79	0,79	0,79	0,79	0,79	0,79	0,79	0,79
Energy consumption (mode per cavity) required to heat a standardized load in a heated oven during a cycle in conventional mode per cavity (electric final energy)	EC	1,23	1,34	1,23	1,10	1,10	1,10	1,10	1,10	1,10	1,10	1,10	1,10	1,10	1,10	1,10	1,10	1,10	1,10	1,10
Energy consumption (mode per cavity) required to heat a standardized load in a heated oven during a cycle in fan-forced mode per cavity (electric final energy)	EC	1,23	1,34	1,23	1,10	1,10	1,10	1,10	1,10	1,10	1,10	1,10	1,10	1,10	1,10	1,10	1,10	1,10	1,10	1,10
Energy efficiency index per cavity	EEl	90,3	86,3	80,2	81,4	81,4	81,4	81,4	81,4	81,4	81,4	81,4	81,4	81,4	81,4	81,4	81,4	81,4	81,4	81,4

FR

DA

DE

EL

EN

ES

FI

IT

NL

PL

PT

SK

SV

Brandt



ISTRUZIONI PER L'UTENTE IT

FORNO

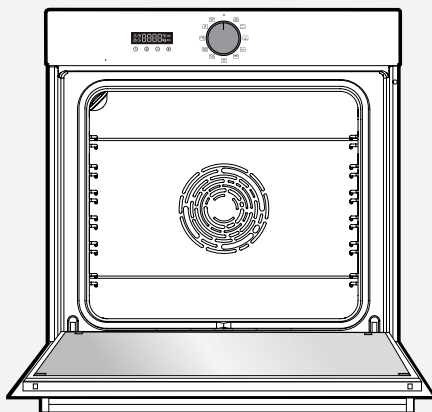

ORIGINE
FRANCE[®]
GARANTIE

BVCert.6011825

Gentile Cliente,

Ha appena acquistato un prodotto **BRANDT** e la ringraziamo della fiducia accordataci.

Abbiamo progettato e fabbricato questo prodotto pensando a lei, al suo stile di vita e alle sue necessità, affinché risponda al meglio alle sue aspettative. Abbiamo impiegato il nostro know-how, lo spirito di innovazione e tutta la passione che ci anima da oltre 60 anni.

Il nostro pensiero costante è sempre quello di soddisfare le sue esigenze: il nostro servizio consumatori è a sua disposizione e al suo ascolto per rispondere a tutte le sue domande o ai suoi suggerimenti.

Visiti anche il nostro sito www.brandt.com, in cui potrà trovare le nostre ultime innovazioni, così come informazioni utili e complementari.

BRANDT è lieto di accompagnarla quotidianamente e le augura di beneficiare a pieno del suo acquisto.



BVCert.6011825

L'etichetta «Origine France Garantie» assicura al consumatore la capacità di un prodotto senza un'indicazione di provenienza chiara e obiettivo. La marca BRANDT è l'etichetta dei prodotti su cui è apposto il marchio di fabbrica francese.

<https://brandt.fr/>

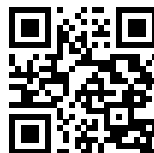

Importante:

Prima di avviare l'apparecchio, leggere attentamente questa guida d'installazione e d'uso al fine di familiarizzarsi più velocemente con il suo funzionamento.



ISTRUZIONI DI SICUREZZA	4
AMBIENTE E RISPARMIO ENERGETICO	6
Ambiente	6
Suggerimento per il risparmio energetico	6
INSTALLAZIONE DELL'APPARECCHIO	7
Scelta della posizione e installazione	7
Collegamento elettrico	8
DESCRIZIONE DEL VOSTRO APPARECCHIO	9
Presentazione del forno	9
Display e tasti di controllo	9
Accessori	10
UTILIZZO DEL DISPOSITIVO	12
Impostazioni	12
Menu Impostazioni	13
Modalità di cottura	14
Avvio di una cottura	15
PRENDERSI CURA DEL PROPRIO DISPOSITIVO	17
Pulizia interna - esterna	18
ANOMALIE E SOLUZIONI	19
ASSISTENZA POST VENDITA	21
Interventi	21
AIUTO IN CUCINA	21
Tabelle di cottura	22
Ricette con lievito madre	24
Test attitudinali funzionali	25
Funzioni con vapore combinato automatico	26



ISTRUZIONI IMPORTANTI PER LA SICUREZZA. LEGGERE ATTENTAMENTE E CONSERVARE PER UN UTILIZZO FUTURO.

Questo manuale è disponibile in download sul sito Internet del marchio.

Alla consegna dell'apparecchio, estrarlo immediatamente dall'imballaggio. Verificarne le condizioni generali.

Scrivere le eventuali riserve sul modulo di consegna, una copia del quale dovrà essere conservata.

Importante:

Questo apparecchio può essere utilizzato da bambini dagli 8 anni in su e da persone con ridotte capacità fisiche, sensoriali o mentali, oppure senza esperienza o conoscenze, se sono sorvegliate o istruite sull'uso in modo sicuro dell'apparecchio e hanno capito i rischi.

— I bambini non devono giocare con l'apparecchio. Le operazioni di pulizia e manutenzione non dovrebbero essere eseguite da bambini privi di sorveglianza.

— Si consiglia di sorvegliare i bambini per accertarsi che non giochino con l'apparecchio.

AVVERTENZA:

— L'apparecchio e le sue parti accessibili si riscaldano durante

l'uso. Fare attenzione a non toccare i termoelementi situati all'interno del forno. I bambini fino a 8 anni devono essere tenuti a distanza a meno che non siano costantemente sorvegliati. — Questo apparecchio è stato progettato per eseguire cotture con la porta chiusa.

— Prima di effettuare la pulizia pirolitica del forno, togliere tutti gli accessori ed eliminare lo sporco più grosso.

— Durante la pulizia, le superfici accessibili diventano più calde rispetto al normale funzionamento.

È opportuno tenere lontani i bambini.

— Non utilizzare un apparecchio per la pulizia al vapore.

— Non utilizzare prodotti abrasivi o spugne metalliche dure per pulire il vetro della porta del forno, in quanto la superficie potrebbe essere scalfita e provocare l'esplosione del vetro.

AVVERTENZA :



Accertarsi che l'apparecchio sia scollegato dalla rete elettrica prima di sostituire la lampada per evitare qualunque rischio di scossa elettrica. Eseguire l'operazione solo a forno freddo. Per svitare più facilmente il coperchio e la lampada, utilizzare un guanto di gomma.

La spina di alimentazione elettrica deve essere accessibile dopo l'installazione. Deve essere possibile scollegare l'apparecchio dalla rete di alimentazione sia con una spina, sia incorporando un interruttore nelle canalizzazioni fisse, conformemente alle regole d'installazione.

— Se il cavo di alimentazione è danneggiato, va sostituito dal costruttore, dal suo servizio post vendita o da una persona qualificata onde evitare pericoli.

— Questo apparecchio può essere installato sotto il piano di lavoro o colonna, come mostrato nello schema di installazione.

— Centrare il forno nel mobile in modo da garantire una distanza minima di 10 mm dal mobile vicino. Il materiale del mobile da incasso deve resistere al calore (o essere rivestito con questo

materiale). Per una maggiore stabilità, fissare il forno nel mobile con due viti passanti dagli appositi fori sui montanti laterali.

— L'apparecchio non deve essere installato dietro una porta decorativa al fine di evitare il surriscaldamento.

— Questo apparecchio è destinato all'utilizzo in applicazioni domestiche e analoghe, come gli angoli cucina riservati al personale di negozi, uffici e altri ambienti professionali; le fattorie; l'utilizzo da parte di clienti di hotel, motel e altri ambienti a carattere residenziale; gli ambienti di tipo bed and breakfast.

— Per qualsiasi intervento di pulizia nel vano del forno, quest'ultimo deve essere spento.

Non modificare le caratteristiche dell'apparecchio, questo rappresenterebbe un pericolo per sé stessi.

Non utilizzare il forno come dispensa per collocarvi degli oggetti dopo l'uso.



TUTELA DELL'AMBIENTE

I materiali d'imballaggio di questo apparecchio sono riciclabili. Per partecipare al riciclaggio e contribuire alla tutela dell'ambiente, si consiglia di gettare l'imballaggio negli appositi contenitori messi a disposizione dal comune.



Anche l'apparecchio contiene molti materiali riciclabili. Portano questo logo per indicare che gli apparecchi usati non devono essere smaltiti con i rifiuti urbani.

Il riciclaggio degli apparecchi organizzato dal costruttore avverrà così nelle migliori condizioni, conformemente alla direttiva europea 2002/96/CE relativa allo smaltimento di apparecchiature elettriche ed elettroniche. Rivolgersi al comune o al rivenditore per conoscere i punti di raccolta di apparecchi usati più vicini al proprio domicilio. La ringraziamo per il Suo contributo alla tutela dell'ambiente.

SUGGERIMENTO PER IL RISPARMIO ENERGETICO

Durante la cottura tenere chiusa la porta del forno.



SCELTA DELLA COLLOCAZIONE INCASSO

Gli schemi definiscono le misure di un mobile nel quale è possibile mettere il forno.

L'apparecchio può essere installato indifferentemente sotto un piano (A) o in un mobile a colonna (B). Se il mobile è aperto, la sua apertura deve essere di 70 mm max sul retro (C et D). Fissare il forno nel mobile. A tal fine, rimuovere gli arresti in gomma e praticare un preforo di $\varnothing 3$ mm nella parete del mobile per evitare che il legno si spacchi. Fissare il forno con le 2 viti. Sostituire gli arresti in gomma.



Consiglio

Per accertarsi di avere effettuato una corretta installazione, non esitare a rivolgerti ad uno specialista di elettrodomestici.



Attenzione:

Se l'impianto elettrico della propria abitazione richiede una modifica per il collegamento dell'apparecchio, rivolgersi ad un elettricista qualificato. Se il forno presenta una anomalia, scollegare l'apparecchio o rimuovere il fusibile corrispondente alla linea di collegamento del forno.

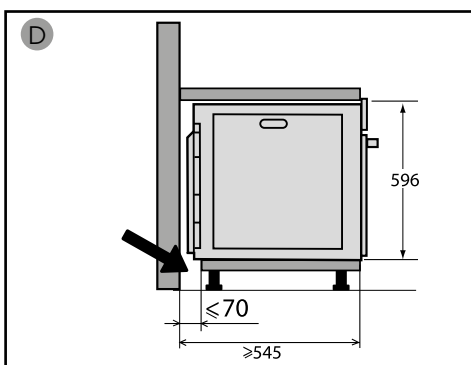
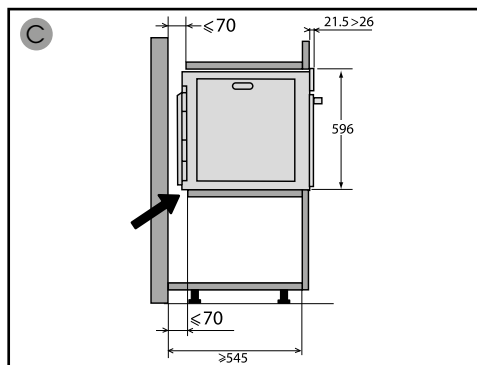
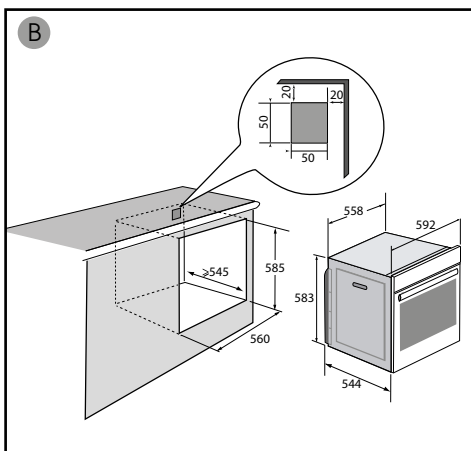
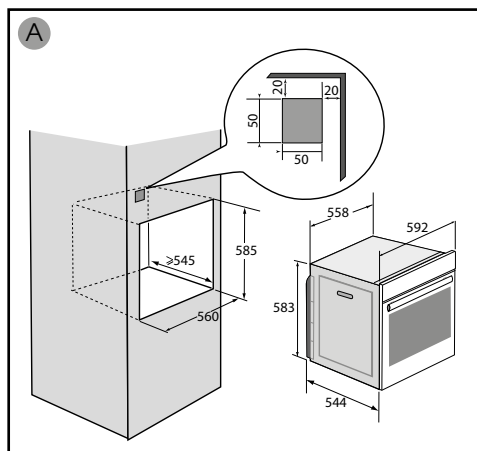



COLLEGAMENTO ELETTRICO

Il forno deve essere collegato con un cavo di alimentazione a norma a 3 conduttori di 1,5 mm² (1 fase + 1 Neutro + terra), che devono essere collegati a loro volta alla rete di 220~240 V tramite una presa di corrente a norma CEI 60083 o un dispositivo a interruzione onnipolare, conformemente alla norme d'installazione.



Attenzione:

Il filo di protezione (verde-giallo) deve essere collegato al terminale dell'apparecchio e al terminale di terra dell'impianto. Il fusibile dell'impianto deve essere di 16 Ampere.

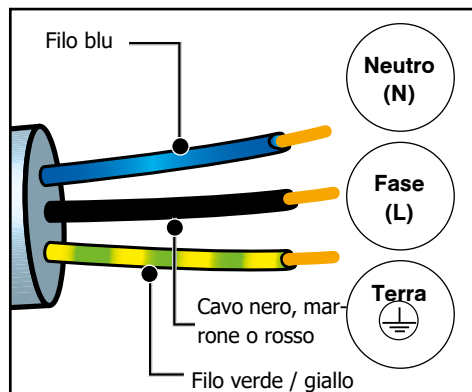

La nostra responsabilità non sarà garantita in caso di incidente causato dalla mancanza di collegamento alla terra, da un collegamento difettoso e non idoneo, o da un collegamento non conforme.

• Prima del primo utilizzo

Prima di utilizzare il forno per la prima volta, riscaldarlo a vuoto, con la porta chiusa, per circa 15 minuti alla massima temperatura. per rompere il dispositivo. La lana minerale che circonda la cavità del forno può inizialmente emanare un odore particolare a causa della sua composizione. Allo stesso modo, potresti notare del fumo. Tutto questo è normale.



Presentazione del forno

PRESENTAZIONE DEL FORNO

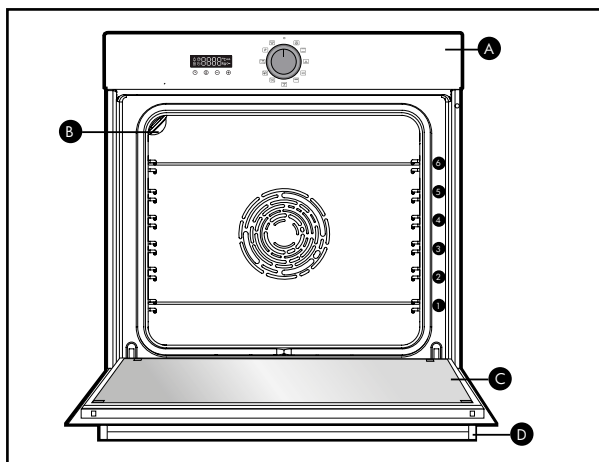

- A** Pannello dei comandi
- B** Lampada
- C** Porta
- D** Maniglia

Il forno dispone di 6 posizioni di guide per gli accessori: guide da 1 a 6.

• Display



- Durata di cottura
- Fine della cottura.
- Blocco della tastiera
- Timer
- Indicatore di temperatura
- Indicatore di preriscaldamento
- Blocco della porta

• Tasti

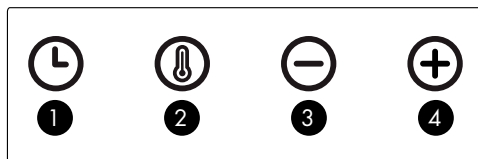

- 1** Regolazione ora e durata
- 2** Regolazione temperatura
- 3** Tasto -
- 4** Tasto +



ACCESSORI

• Griglia sicurezza antiribaltamento

La griglia può essere utilizzata per sostenere tutti i piatti e gli stampi degli alimenti da cuocere o da gratinare. Può essere utilizzata per le grigliate (da mettere direttamente sopra).

Inserire la griglia sicurezza antiribaltamento verso il fondo del forno

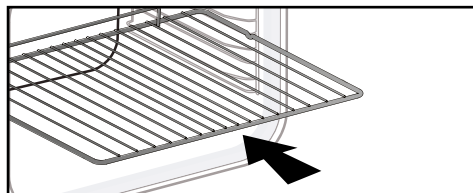

• Teglia multiuso leccarda 45mm

Inserita nelle guide sotto la griglia, impugnatura verso la porta del forno. Raccoglie il succo e il grasso delle grigliate. Se viene riempita d'acqua fino a metà, può essere usata per le cotture a bagnomaria.

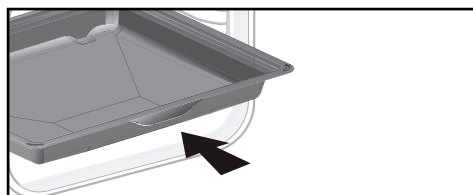

• Teglia per pasticceria 20mm

Inserita nelle guide, impugnatura verso la porta del forno. Ideale per la cottura di cookie, biscotti sablé, cupcake. Il suo piano inclinato permette di riporre facilmente le preparazioni in un piatto. Può anche essere inserita nelle guide sotto la griglia, per raccogliere il succo e il grasso delle grigliate.

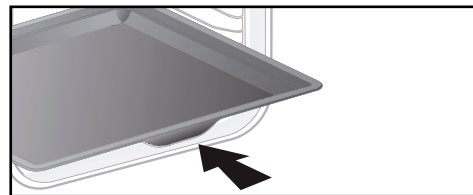

• Sistema di guide scorrevoli

Grazie al sistema di guide scorrevoli, la manipolazione degli alimenti diventa più pratica e facile poiché le teglie possono essere rimosse delicatamente, semplificandone al massimo l'utilizzo. Le piastre possono essere estratte completamente, consentendo in tal modo un accesso totale.

Inoltre, la loro stabilità permette di lavorare e maneggiare gli alimenti in tutta sicurezza, riducendo il rischio di bruciature. È possibile quindi estrarre gli alimenti dal forno con estrema facilità.

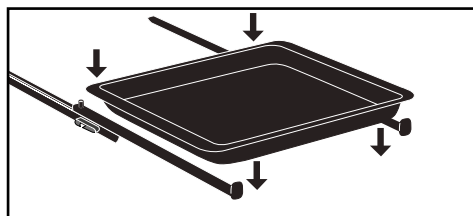

Attenzione:

Rimuovere gli accessori e i ripiani del forno prima di avviare una pulizia mediante pirolisi.

Attenzione:

Sotto l'effetto del calore gli accessori possono deformarsi senza che questo comprometta la loro funzione. Questi riprenderanno la forma originale una volta raffreddati.



INSTALLAZIONE E SMONTAGGIO DELLE GUIDE SCORREVOLI

Dopo aver rimosso i 2 supporti ripiani, scegliere l'altezza dei ripiani (da 2 a 5) a cui si desidera fissare le guide. Inserire la guida sinistra nel ripiano sinistro effettuando una pressione sufficiente sulla parte anteriore e posteriore della guida affinché le 2 linguette sul lato della guida entrino nel ripiano. Procedere allo stesso modo per la guida destra.

NOTA: la parte scorrevole telescopica della guida deve estendersi verso la parte anteriore del forno, l'arresto **A** si trova di fronte a sé.

Posizionare i 2 supporti ripiani e poggiare la teglia sulle 2 guide, il sistema è pronto all'uso.

Per smontare le guide, rimuovere nuovamente i supporti ripiani.

Spingere leggermente verso il basso le linguette fissate su ogni guida per liberarle dal ripiano. Tirare la guida verso di sé.

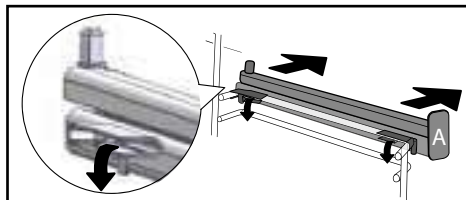
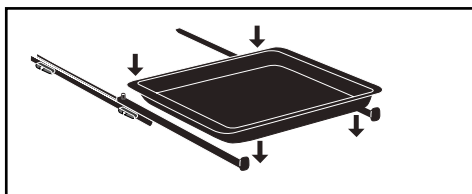
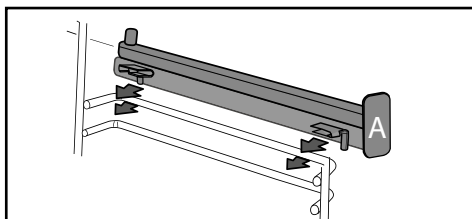

Consiglio

Al fine di evitare la produzione di fumo durante la cottura di carni grasse, si raccomanda di aggiungere una piccola quantità d'acqua o di olio sul fondo della leccarda.





Utilizzando il tuo dispositivo

REGOLAZIONI

• Regolazione dell'ora

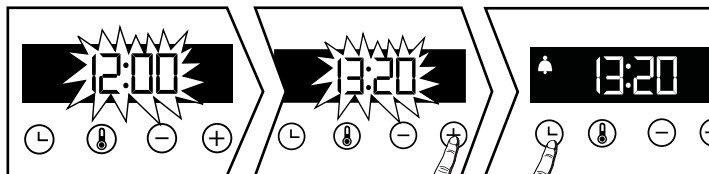
Alla messa sotto tensione il display lampeggia 12.00.





Regolare l'ora con i tasti + o -. Convalidare con il tasto . In caso di interruzione di corrente, l'ora lampeggia

• Modifica dell'ora

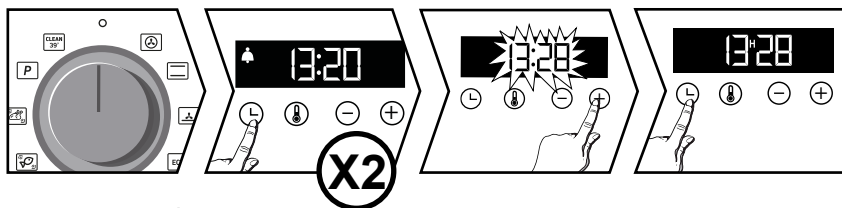
Il selettore di funzione deve obbligatoriamente essere sulla posizione 0.





Premere il tasto  appare il simbolo timer  lampeggia premere di nuovo . modificare la regolazione dell'ora con i tasti + o -. Convalidare con il tasto . La registrazione del tempo regolato è automatica dopo pochi secondi.

• Timer

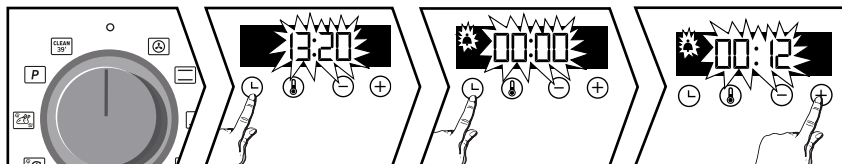
Questa funzione può essere utilizzata unicamente con il forno spento.



Il selettore di funzione deve obbligatoriamente essere sulla posizione 0.

Premere il tasto  appare il simbolo timer  lampeggia. Regolare il timer con i tasti + e -. Convalidare con il tasto .



NB: è possibile modificare o annullare la programmazione del timer in qualsiasi momento. Per annullare, tornare al menu del timer e regolare su 00.00. Senza convalida, il salvataggio si effettua automaticamente dopo qualche secondo.

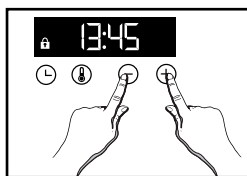

Utilizzando il tuo dispositivo

• Blocco della tastiera



Premere contemporaneamente i tasti + e - fino a quando il simbolo  viene visualizzato sul display. Per sbloccarla, premere contemporaneamente i tasti + e - fino a quando il simbolo  scompare dal display.

REGOLAZIONI



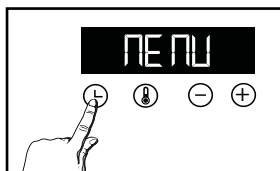

È possibile intervenire su diversi parametri del proprio forno, per fare questo:

Premere il tasto  fino alla visualizzazione di **"MENU"** per accedere alla modalità di regolazione.



Premere nuovamente il tasto  per far scorrere le diverse regolazioni.

Attivare o disattivare con i tasti + e - i differenti parametri, vedere tabella di seguito:

	AUTO: In modalità di cottura, la spia cavità si spegne dopo 90 secondi ON: In modalità cottura la lampada è sempre accesa .
	Attivare/disattivare il bip dei tasti
	Attiva / disattiva la modalità di preriscaldamento
	Attivare/disattivare la modalità demo

Per uscire dal "MENU", premere nuovamente .



Utilizzando il tuo dispositivo

MODALITÀ DI COTTURA

Funzioni manuali:



TERMOVENTILAZIONE*

Temperatura min 35 °C max 275°C

Raccomandato per mantenere le carni bianche, il pesce e le verdure teneri. Per le cotture multiple fino a 3 livelli.



TRADIZIONALE

Temperatura min 35 °C max 275°C

Raccomandato per cotture lente e delicate: selvaggina tenera. Per cucinare velocemente arrosti di carne rossa. Per cucinare lentamente in pentole di ghisa coperte piatti precedentemente cucinati sul piano cottura (gallo al vino, salmi).



SUOLA VENTILATA

Temperatura min 75°C max 250 °C

Raccomandata per piatti umidi (quiche, torte alla frutta succulente...). La pasta sarà ben cotta sotto. Raccomandata per le preparazioni che lievitano (cake, brioche, kouglof) e per i soufflé che non saranno bloccati da una crosta superficiale.



ECO*

Temperatura min 35 °C max 275 °C

Questa posizione permette di risparmiare energia conservando le qualità di cottura.

Tutte le cotture vengono effettuate senza preriscaldamento.



GRILL FORTE

Temperatura min 180°C max 275°C



GRILL VENTILATO

Temperatura min 100°C max 250°C

Pollame e arrosti succulenti e croccanti su tutti i lati. Inserire la leccarda nella guida inferiore.

Raccomandato per il pollame e gli arrosti, per una cottura veloce e completa di cosce e costata di manzo. Per mantenere umide le bistecche di pesce.

Funzioni automatiche:

Brandt propone 3 nuove funzioni che combinano automaticamente due modalità di cottura: la cottura tradizionale e quella al vapore, al fine di preservare le qualità nutrizionali degli alimenti e di ottenere una cottura più rapida.



CARNI BIANCHE

Raccomandato per mantenere la tenerezza degli arrosti di maiale e di agnello.



PESCE

Raccomandato per la cottura di pesci interi o di filetti.



POLLAME

Raccomandato per la cottura di pollo, tacchino, faraona e anatra.

Per queste 3 funzioni occorre introdurre acqua tiepida in quantità sufficiente nel piatto (leccarda) e posizionarlo nel forno nel ripiano inferiore; l'alimento da cuocere deve invece cuocere nel ripiano di livello 3.

Per quanto riguarda la quantità d'acqua da introdurre nella leccarda, fare riferimento alla tabella delle funzioni combinate automatiche con associazione di vapore alla fine delle istruzioni.



"Smart Assist"

Il forno è dotato della funzione "SMART ASSIST" che durante la programmazione di durata suggerirà una durata di cottura modificabile in funzione della modalità di cottura scelta.

**Modalità di cottura realizzata conformemente alle prescrizioni della norma EN 60350-1: 2016 per mostrare la conformità ai requisiti di etichettatura energetica del regolamento europeo UE/65/2014.*



Utilizzando il tuo dispositivo

AVVIO DI UNA COTTURA

• Cottura immediata

Il programmatore dovrebbe visualizzare solo l'ora. Questo non dovrebbe lampeggiare. Ruotare il selettore delle funzioni nella posizione desiderata.

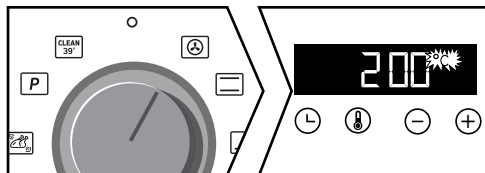



Per le funzioni manuali:

L'aumento della temperatura inizia immediatamente. Il forno suggerisce una temperatura, che può essere modificata. Il forno si riscalda e l'indicatore di temperatura lampeggia. Viene emessa una serie di bip quando il forno raggiunge la temperatura programmata.

Per le funzioni automatiche:

 appare sullo schermo.

Selezionare il proprio alimento servendosi della tabella alla fine delle istruzioni. Premere i tasti + e - fino a ottenere lo schema desiderato nel display, poi confermare con il tasto .

Il peso lampeggia. Inserire il peso reale dell'alimento con i tasti + e - poi confermare .

Non serve regolare altro: la temperatura e la durata di cottura sono calcolate automaticamente. L'ora di fine cottura lampeggia. Confermare con il tasto . La cottura inizia immediatamente.



• Modifica della temperatura

Premere .

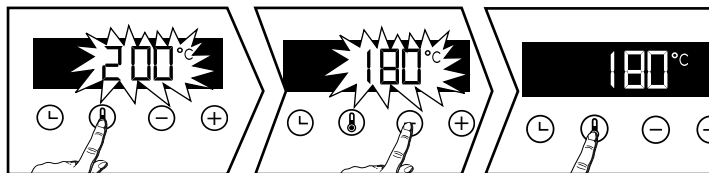
Regolare la temperatura con + o -. Convalidare premendo .



• Programmazione della durata

Effettuare una cottura immediata, poi premere , a durata di cottura  lampeggia, la regolazione è ora possibile. Premere + o - per regolare la durata di cottura.

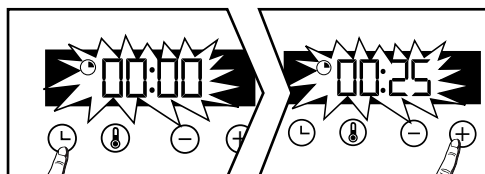



Il forno è dotato della funzione "SMART ASSIST" che durante la programmazione di durata suggerirà una durata di cottura modificabile in funzione della modalità di cottura scelta. Vedere la tabella di seguito:

Il salvataggio del tempo di cottura viene effettuato automaticamente dopo qualche secondo. Il conteggio della durata viene effettuato immediatamente non appena la temperatura di cottura viene raggiunta.

FUNZIONE DI COTTURA	RACCOMANDAZIONE DELLA DURATA
	30 min
	30 min
	30 min
	30 min
	7 min
	15 min

• Cottura partenza differita

Procedere come per una durata programmata. Dopo la regolazione della durata di cottura, premere il tasto , il tempo di fine cottura lampeggia .

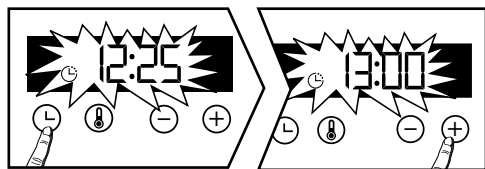

Il display lampeggia, regolare l'ora di fine cottura con + o -.

Il salvataggio di fine cottura è automatico dopo qualche secondo. Il display di fine cottura non lampeggia più.



PULIZIA INTERNA - ESTERNA

• Pulizia della cavità mediante pirolisi





Attenzione

Rimuovere gli accessori e i supporti ripiani del forno prima di avviare una pulizia mediante pirolisi. Prima di procedere a una pulizia mediante pirolisi del forno, rimuovere le eventuali fuoriuscite. Rimuovere l'eccesso di grasso sulla porta con una spugna umida.

Per motivi di sicurezza, l'operazione di pulizia mediante pirolisi avviene solo previo bloccaggio automatico della porta, è impossibile sbloccare la porta.

• Pulizia automatica immediata

Il programmatore deve visualizzare l'ora senza lampeggiare. Selezionare uno dei cicli di pulizia automatica immediata con la manopola delle funzioni  o  :

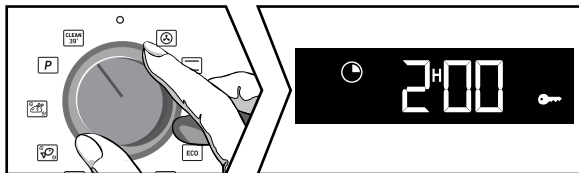



= Pulizia in 39 minuti

- A ogni fine cottura "Clean 39" scorre sullo schermo per proporre di avviare questa pulizia. Posizionare la manopola su questa funzione e confermare con il tasto . La durata 0:39 viene visualizzata alternandosi con l'indicazione "Clean 39": la pulizia inizia. Dopo qualche minuto appare una chiave, la porta del forno viene automaticamente bloccata per sicurezza durante tutto il programma.

Le condizioni di avvio del programma non permettono di lanciare "Clean 39" con il forno freddo o non sufficientemente caldo. Il display mostrerà 0:00 e sarà quindi necessario scegliere l'altra posizione di pulizia automatica .

= Pirolisi di 2 ore. Posizionare la manopola su questa funzione.



Posizionare la manopola su questa funzione. Il display mostra . Premere + per scegliere la pirolisi in funzione del grado di sporchezza del forno.

In funzione della scelta, viene mostrata la durata di 2 ore. Convalidare con il tasto . . Inizia la pirolisi.

Alla fine della pulizia, il display indica 0:00 e la porta si sblocca.

Riportare il selettore di funzione su 0.

• Pulizia automatica differita

È possibile differire la partenza della pirolisi. Quando la durata del programma appare sullo schermo, premere il tasto  e regolare la nuova ora di termine con il tasto + e -, poi confermare con . La pulizia automatica inizierà nuovamente per terminare alla nuova ora programmata. Rimettere il selettore delle funzioni su 0 alla fine della pulizia.



• Pulizia della superficie esterna

Utilizzare un panno morbido imbevuto di detersivo per vetri. Non utilizzare creme per lucidare né spugne abrasive.

• Pulizia dei cavalletti

Smontare i cavi dei gradini per pulirli. Sollevare la parte anteriore del gradino; spingere l'intero gradino verso l'alto e sganciare il gancio anteriore dalla sua sede. Quindi tirare leggermente l'intero gradino verso di sé in modo da liberare i ganci posteriori dalla loro sede. Rimuovi i 2 passaggi.

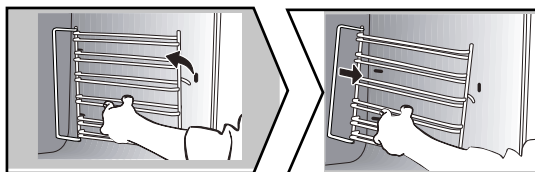

• Pulizia del vetro della porta

Avvertenza

Non utilizzare prodotti abrasivi per lucidare, spugne abrasive o metalliche per pulire il vetro della porta del forno, in quanto la superficie potrebbe essere scalfita e provocare l'esplosione del vetro.

Rimuovere prima il grasso in eccesso dal vetro interno con un panno morbido e detersivo per piatti. Per pulire le diverse finestre interne, scoprirlo rimuovendole come segue:

• Pulizia del vetro della porta

Aprire completamente la porta e bloccarla con lo spessore in plastica fornito nella busta di plastica dell'apparecchio.

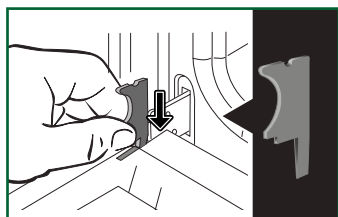

Rimuovere il primo pannello ritagliato: premere con uno strumento (cacciavite) nelle posizioni (A) per sganciare il vetro, quindi rimuoverlo.

Avvertenza

Assicurati di segnare la direzione di montaggio di questa prima finestra (lato lucido verso di te)



A seconda del modello, la porta è composta da due lastre aggiuntive con un distanziatore in gomma nera ad ogni angolo. Se necessario, rimuoverli per la pulizia.

Non immergere le finestre nell'acqua. Risciacquare con acqua pulita e asciugare con un panno privo di lanugine.

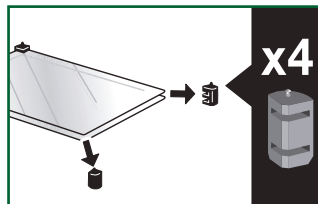
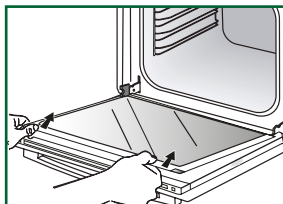
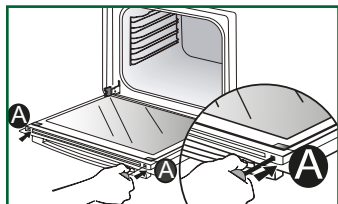

• Rimontaggio della porta

Dopo la pulizia, riposizionare l'ultimo vetro e inserirlo negli arresti metallici, poi fissarlo con le clip, con il lato brillante verso l'esterno.

Rimuovere lo spessore in plastica.

L'apparecchio è di nuovo pronto per funzionare.

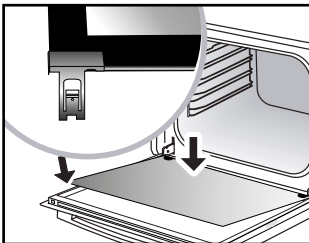
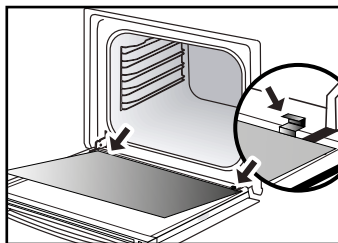
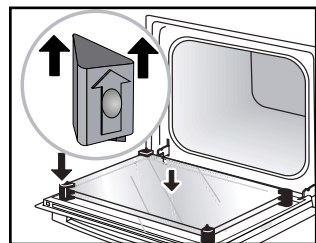

• Sostituzione della lampada

Avvertenza:

Accertarsi che l'apparecchio sia scollegato dalla rete elettrica prima di sostituire la lampada per evitare qualunque rischio di scossa elettrica. Eseguire l'operazione solo a forno freddo.

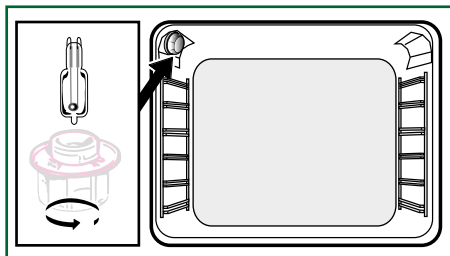

Caratteristiche della lampada:

25 W, 220-240 V~, 300°C, attacco G9.

Per svitare più facilmente il coperchio e la lampada, utilizzare un guanto di gomma.



ANOMALIE E SOLUZIONI

Il forno non riscalda. Verificare che il forno sia correttamente collegato o che il fusibile del proprio impianto non sia fuori servizio. Aumentare la temperatura selezionata.

La lampada del forno non funziona più. Sostituire la lampada o il fusibile. Verificare che il forno sia correttamente collegato.

La ventola di raffreddamento continua a girare dopo lo spegnimento del forno.

È normale, la ventilazione può continuare fino a un'ora al massimo dopo la cottura per far diminuire la temperatura interne ed esterna del forno. Dopo un'ora, contattare il Servizio post-vendita.

Le nettoyage par pyrolyse ne se fait pas.

Vérifiez la fermeture de la porte. Il peut s'agir d'un défaut de verrouillage de la porte ou du capteur de température. Si le défaut persiste, contactez le Service Après-Vente.

Il simbolo  lampeggia sul display.

Anomalia blocco porta, chiamare il servizio di assistenza.

Rumore vibrante.

Verificare che il cavo di alimentazione non sia a contatto con la parete posteriore.

Ciò non ha alcun impatto sul corretto funzionamento del dispositivo, ma può comunque generare un rumore vibrante durante la ventilazione. Rimuovi il dispositivo e sposta il cavo. Sostituisci il forno.



INTERVENTI

Gli eventuali interventi sull'apparecchio devono essere effettuati da personale qualificato e autorizzato dalla ditta concessionaria del marchio. Prima di chiamare, per facilitare la presa in carico della richiesta, munirsi dei riferimenti completi dell'apparecchio (riferimento commerciale, riferimento servizio, numero di serie). Queste informazioni sono riportate sulla targhetta segnaletica.

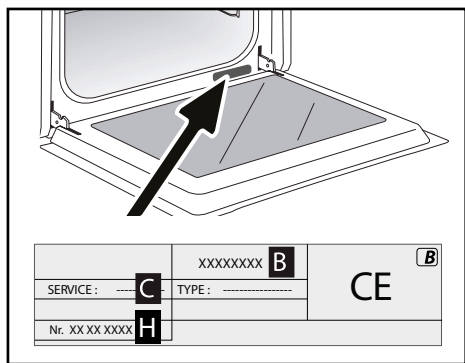

- B: Riferimento commerciale
- C: Riferimento servizio
- H: Numero di serie

PEZZI ORIGINALI

In occasione di un intervento di manutenzione, richiedere l'utilizzo esclusivo di **pezzi di ricambio originali certificati**.





PIATTI	* * * * * * * *												min	
Carne														
Arrosto di maiale (1 kg)	200	2					180	2						60
Arrosto di vitello (1 kg)	200	2					180	2						60-70
Arrosto di manzo	240	2												30-40
Agnello (cosciotto, spalla 2,5 kg)	220	1			220						200	2		60
Pollame (1 kg)	200	2			220		180	2			210	3		60
Pollame grandi pezzi	180	1												60-90
Cosce di pollo					220	3					210	3		20-30
Costata di maiale/vitello					210	3								20-30
Costata di manzo (1 kg)					210	3					210	3		20-30
Costata di pecora					210	3								20-30
Pesce														
Pesce grigliato					275	4								15-20
Pesce cotto	200	3					180	3						30-35
Pesce al cartoccio	220	3					200	3						15-20
Verdure														
Gratinatura (alimenti cotti)					275	2								30
Gratin dauphinois	200	2					180	2						45
Lasagne	200	3					180	3						45
Pomodori farciti	170	3					160	2						30
Prodotti di pasticceria														
Pan di Spagna - Pâte génoise			180	2								180	2	35
Biscotto arrotolato	220	3										180	2	5-10
Brioche	180	1	210									180	2	35-45
Brownie	180	2					175	3						20-25
Cake - Quatre-quarts	180	1	180	1								180	2	45-50
Clafoutis	200	2					180	3						30-35
Crema	165	2										150	2	30-40

* a seconda del modello



PIATTI	* * * * * * *								min									
Prodotti di pasticceria																		
Madeleine	220	3					200	3										5-10
Pasta choux	200	3					180	3							180	3		30-40
Petits four a sfoglia	220	3					200	3										5-10
Savarin	180	3													175	3		30-35
Torta pasta frolla	200	1					195	1										30-40
Torta pasta sfoglia sottile	215	1					200	1										20-25
Torta pasta lievitata	210	1					200	1										10-30
Altro																		
Spiedini	220	3			210	4												10-15
Pâté in terrina	200	2					190	2										80-100
Pizza pasta frolla	200	2																30-40
Pizza impasto di pane																		15-18
Quiche																		35-40
Soufflé														180	2			50
Torta salata	200	2																40-45
Pane	220						200		220									30-40
Pane grigliato	180				275	4-5												2-3
Pentole chiuse (daube)	180	2												180	2			90-180

* a seconda del mo-



Tutte le T °C e tempi di cottura sono dati per forni preriscaldati

N.B: Prima di metterla in forno, la carne deve restare almeno 1 ora a temperatura ambiente.

EQUIVALENZA: NUMERI T °C

°C	30	60	90	120	150	180	210	240	275
Numeri	1	2	3	4	5	6	7	8	9 maxi



Ricetta con lievito (a seconda del modello)

Ingredienti:

- Farina 2 kg
- Acqua 1240 ml
- Sale 40 g
- 4 pacchetti di lievito per panificazione disidratato.

Mescolare l'impasto con il mixer e fare lievitare la pasta nel forno.





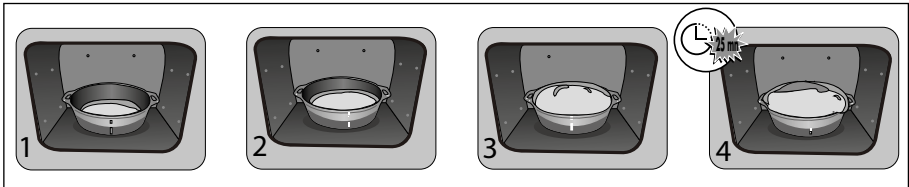







Procedimento: Per le ricette di impasto a base di lievito. Versare l'impasto in una teglia resistente al calore, togliere i supporti delle guide laterali e porre la teglia sulla suola.

Preriscaldare il forno con la funzione «termoventilazione» a 40-50 °C per 5 minuti. Spegner il forno e lasciare lievitare l'impasto per 25-30 minuti grazie al calore residuo.





TEST DI IDONEITÀ ALLA FUNZIONE SECONDO LA NORMA CEI 60350

ALIMENTO	*Modalità di cottura	LIVELLO	Accessori	°C	DURATA min.	PRERISCALDAMENTO
Biscotti sablé (8.4.1)		5	teglia 45 mm	150	30-40	sì
Biscotti sablé (8.4.1)		5	teglia 45 mm	150	25-35	sì
Biscotti sablé (8.4.1)		2 + 5	teglia 45 mm + griglia	150	25-45	sì
Biscotti sablé (8.4.1)		3	teglia 45 mm	175	25-35	sì
Biscotti sablé (8.4.1)		2 + 5	teglia 45 mm + griglia	160	30-40	sì
Piccole torte (8.4.2)		5	teglia 45 mm	170	25-35	sì
Piccole torte (8.4.2)		5	teglia 45 mm	170	25-35	sì
Piccole torte (8.4.2)		2 + 5	teglia 45 mm + griglia	170	20-40	sì
Piccole torte (8.4.2)		3	teglia 45 mm	170	25-35	sì
Piccole torte (8.4.2)		2 + 5	teglia 45 mm + griglia	170	25-35	sì
Dolci morbidi senza grassi (8.5.1)		4	griglia	150	30-40	sì
Dolci morbidi senza grassi (8.5.1)		4	griglia	150	30-40	sì
Dolce morbido senza grassi (8.5.1)		2 + 5	teglia 45 mm + griglia	150	30-40	sì
Dolci morbidi senza grassi (8.5.1)		3	griglia	150	30-40	sì
Dolci morbidi senza grassi (8.5.1)		2 + 5	teglia 45 mm + griglia	150	30-40	sì
Torta alle mele (8.5.2)		1	griglia	170	90-120	sì
Torta alle mele (8.5.2)		1	griglia	170	90-120	sì
Torta alle mele (8.5.2)		3	griglia	180	90-120	sì
Superficie gratinata (9.2.2)		5	griglia	275	3-6	sì

* A seconda del modello

NOTA: Per le cotture a 2 livelli, le teglie possono essere estratte in tempi differenti.



TABELLA DELLE FUNZIONI COMBinate AUTOMATICHE CON ASSOCIAZIONE DI VAPORE

Posizione della manopola	Visualizzazione nel programmatore	Alimenti	Quantità di acqua da aggiungere
		Pollo	500 ml di acqua tiepida nella leccarda
		Anatra	500 ml di acqua tiepida nella leccarda
		Tacchino	500 ml di acqua tiepida nella leccarda
		Faraona	800 ml di acqua tiepida nella leccarda
		Pesce intero (grande)	500 ml di acqua tiepida nella leccarda
		Pesce intero (piatti)	300 ml di acqua tiepida nella leccarda
		Pesci piccoli interi	300 ml di acqua tiepida nella leccarda
		Filetti di pesce	300 ml di acqua tiepida nella leccarda
		Maiale arrosto	500 ml di acqua tiepida nella leccarda
		Vitello arrosto	500 ml di acqua tiepida nella leccarda

IMPORTANTE:

Posizionare la leccarda (con acqua tiepida) nel ripiano inferiore, livello 1, e l'alimento da cuocere nel ripiano di livello 3.

EN	Information for domestic ovens (UE n° 662014)	DE	Informationen zu Haushaltsbacköfen (UE n° 662014)
FR	Informations concernant les fours domestiques (UE n° 662014)	ES	Información sobre los hornos domésticos (UE n° 662014)
CS	Informace týkající se troupek domácího (UE n° 662014)	IT	Informazione relative ai forni per uso domestico (UE n° 662014)
DA	Oplysninger for ovne til husholdningsbrug (UE n° 662014)	NL	Informatie met betrekking tot huishoudelijke ovens (UE n° 662014)
EL	Πληροφορίες για οικιακά φούρνους (UE n° 662014)	FI	kotiseuranneiden uunien tiedot (UE n° 662014)

EN	FR	DE	ES	CS	IT	DA	NL	FI	Unit	EN Symbol	FR Valeur	DE	ES	CS	IT	DA	NL	FI
Type norme	EN 50466-1:2014	KH725P	KH725W	KH725W	KH725W	KH725W	KH725W	KH725W	KH725W	KH725W	KH725W	KH725W	KH725W	KH725W	KH725W	KH725W	KH725W	KH725W
Models identification	FR: Impuls-C5, Indomedia, DA: Elnel-DE: Elnel-ES: Simple-IT: Simple-NL: Simple-P: Polynorm-PPT Simple-SK: Polynorm-PPT Simple-SL: AnusCF: Vissastaran-SV: Barel.	KCD25P	KCD25T	KXD25P	KXD25T	KXD25P	KXD25T	KXD25P	KXD25T	KXD25P	KXD25T	KXD25P	KXD25T	KXD25P	KXD25T	KXD25P	KXD25T	KXD25P
Type of oven	Simple	34.5	30.7	35.7	33.5	36.2	35.6	35.0	33.5	35.6	35.0	35.0	35.0	33.0	34.1	33.0	34.1	33.0
Mass of the appliance	M	1	1	1	1	1	1	1	1	1	1	1	1	1	1	1	1	1
Number of cavities		1	1	1	1	1	1	1	1	1	1	1	1	1	1	1	1	1
Heat source per cavity (type of fuel or gas)	FR: Electricité-CS: Biométhane-DA:DE: Biométhane-E:Electricité-IT: Energia elettrica-NL: Electriciteit-Electricity-PT: Energia elétrica-SK: Elektrická-EL: Ηλεκτρική-EN: Electric																	
Volume per cavity	V	730	730	730	730	730	730	730	730	730	730	730	730	730	730	730	730	730
Energy consumption (method used to heat a standardised load in electric mode per cycle in fan-forced mode per cavity (electric final energy))	EC	0.82	0.82	0.89	0.79	0.79	0.79	0.79	0.79	0.79	0.79	0.79	0.79	0.79	0.79	0.79	0.79	0.79
Energy consumption (method used to heat a standardised load in electric mode per cycle in fan-forced mode per cavity (electric final energy))	EC	1.23	1.34	1.23	1.10	1.10	1.10	1.10	1.10	1.10	1.10	1.10	1.10	1.10	1.10	1.10	1.10	1.10
Energy efficiency index per cavity	EEl	90.3	86.3	80.2	81.4	81.4	81.4	81.4	81.4	81.4	81.4	81.4	81.4	81.4	81.4	81.4	81.4	81.4

EN: Symbol-FR: Symbole-CS: Značka-DE: Symbol-E: Símbolo-IT: Simbolo-SK: Symbol-EL: Σύμβολο-FI: Symboli-EN: Unit-FR: Unité-CS: Jednotka-DE: Einheit-ES: Unidad-IT: Unità-PT: Unidade-SK: jednotka-EL: Μονάδα-FI: Yksikö-EN: Type norme-FR: Type norme-CS: Model-DA: Normtype-DE: Typ-ES: Modelo-IT: Tipo di norma-SK: Stanovitný typ-EL: Τύπος/νομοτύπος-FI: Suorituslajityyppi-SV: Typ nr. norm.	EN: Symbol-FR: Symbole-CS: Značka-DE: Symbol-E: Símbolo-IT: Simbolo-SK: Symbol-EL: Σύμβολο-FI: Symboli-EN: Unit-FR: Unité-CS: Jednotka-DE: Einheit-ES: Unidad-IT: Unità-PT: Unidade-SK: jednotka-EL: Μονάδα-FI: Yksikö-EN: Type norme-FR: Type norme-CS: Model-DA: Normtype-DE: Typ-ES: Modelo-IT: Tipo di norma-SK: Stanovitný typ-EL: Τύπος/νομοτύπος-FI: Suorituslajityyppi-SV: Typ nr. norm.	EN: Unit-FR: Unité-CS: Jednotka-DE: Einheit-ES: Unidad-IT: Unità-PT: Unidade-SK: jednotka-EL: Μονάδα-FI: Yksikö-EN: Type norme-FR: Type norme-CS: Model-DA: Normtype-DE: Typ-ES: Modelo-IT: Tipo di norma-SK: Stanovitný typ-EL: Τύπος/νομοτύπος-FI: Suorituslajityyppi-SV: Typ nr. norm.	EN: Unit-FR: Unité-CS: Jednotka-DE: Einheit-ES: Unidad-IT: Unità-PT: Unidade-SK: jednotka-EL: Μονάδα-FI: Yksikö-EN: Type norme-FR: Type norme-CS: Model-DA: Normtype-DE: Typ-ES: Modelo-IT: Tipo di norma-SK: Stanovitný typ-EL: Τύπος/νομοτύπος-FI: Suorituslajityyppi-SV: Typ nr. norm.	EN: Unit-FR: Unité-CS: Jednotka-DE: Einheit-ES: Unidad-IT: Unità-PT: Unidade-SK: jednotka-EL: Μονάδα-FI: Yksikö-EN: Type norme-FR: Type norme-CS: Model-DA: Normtype-DE: Typ-ES: Modelo-IT: Tipo di norma-SK: Stanovitný typ-EL: Τύπος/νομοτύπος-FI: Suorituslajityyppi-SV: Typ nr. norm.	EN: Unit-FR: Unité-CS: Jednotka-DE: Einheit-ES: Unidad-IT: Unità-PT: Unidade-SK: jednotka-EL: Μονάδα-FI: Yksikö-EN: Type norme-FR: Type norme-CS: Model-DA: Normtype-DE: Typ-ES: Modelo-IT: Tipo di norma-SK: Stanovitný typ-EL: Τύπος/νομοτύπος-FI: Suorituslajityyppi-SV: Typ nr. norm.	EN: Unit-FR: Unité-CS: Jednotka-DE: Einheit-ES: Unidad-IT: Unità-PT: Unidade-SK: jednotka-EL: Μονάδα-FI: Yksikö-EN: Type norme-FR: Type norme-CS: Model-DA: Normtype-DE: Typ-ES: Modelo-IT: Tipo di norma-SK: Stanovitný typ-EL: Τύπος/νομοτύπος-FI: Suorituslajityyppi-SV: Typ nr. norm.	EN: Unit-FR: Unité-CS: Jednotka-DE: Einheit-ES: Unidad-IT: Unità-PT: Unidade-SK: jednotka-EL: Μονάδα-FI: Yksikö-EN: Type norme-FR: Type norme-CS: Model-DA: Normtype-DE: Typ-ES: Modelo-IT: Tipo di norma-SK: Stanovitný typ-EL: Τύπος/νομοτύπος-FI: Suorituslajityyppi-SV: Typ nr. norm.	EN: Unit-FR: Unité-CS: Jednotka-DE: Einheit-ES: Unidad-IT: Unità-PT: Unidade-SK: jednotka-EL: Μονάδα-FI: Yksikö-EN: Type norme-FR: Type norme-CS: Model-DA: Normtype-DE: Typ-ES: Modelo-IT: Tipo di norma-SK: Stanovitný typ-EL: Τύπος/νομοτύπος-FI: Suorituslajityyppi-SV: Typ nr. norm.	EN: Unit-FR: Unité-CS: Jednotka-DE: Einheit-ES: Unidad-IT: Unità-PT: Unidade-SK: jednotka-EL: Μονάδα-FI: Yksikö-EN: Type norme-FR: Type norme-CS: Model-DA: Normtype-DE: Typ-ES: Modelo-IT: Tipo di norma-SK: Stanovitný typ-EL: Τύπος/νομοτύπος-FI: Suorituslajityyppi-SV: Typ nr. norm.	EN: Unit-FR: Unité-CS: Jednotka-DE: Einheit-ES: Unidad-IT: Unità-PT: Unidade-SK: jednotka-EL: Μονάδα-FI: Yksikö-EN: Type norme-FR: Type norme-CS: Model-DA: Normtype-DE: Typ-ES: Modelo-IT: Tipo di norma-SK: Stanovitný typ-EL: Τύπος/νομοτύπος-FI: Suorituslajityyppi-SV: Typ nr. norm.	EN: Unit-FR: Unité-CS: Jednotka-DE: Einheit-ES: Unidad-IT: Unità-PT: Unidade-SK: jednotka-EL: Μονάδα-FI: Yksikö-EN: Type norme-FR: Type norme-CS: Model-DA: Normtype-DE: Typ-ES: Modelo-IT: Tipo di norma-SK: Stanovitný typ-EL: Τύπος/νομοτύπος-FI: Suorituslajityyppi-SV: Typ nr. norm.	EN: Unit-FR: Unité-CS: Jednotka-DE: Einheit-ES: Unidad-IT: Unità-PT: Unidade-SK: jednotka-EL: Μονάδα-FI: Yksikö-EN: Type norme-FR: Type norme-CS: Model-DA: Normtype-DE: Typ-ES: Modelo-IT: Tipo di norma-SK: Stanovitný typ-EL: Τύπος/νομοτύπος-FI: Suorituslajityyppi-SV: Typ nr. norm.	EN: Unit-FR: Unité-CS: Jednotka-DE: Einheit-ES: Unidad-IT: Unità-PT: Unidade-SK: jednotka-EL: Μονάδα-FI: Yksikö-EN: Type norme-FR: Type norme-CS: Model-DA: Normtype-DE: Typ-ES: Modelo-IT: Tipo di norma-SK: Stanovitný typ-EL: Τύπος/νομοτύπος-FI: Suorituslajityyppi-SV: Typ nr. norm.	EN: Unit-FR: Unité-CS: Jednotka-DE: Einheit-ES: Unidad-IT: Unità-PT: Unidade-SK: jednotka-EL: Μονάδα-FI: Yksikö-EN: Type norme-FR: Type norme-CS: Model-DA: Normtype-DE: Typ-ES: Modelo-IT: Tipo di norma-SK: Stanovitný typ-EL: Τύπος/νομοτύπος-FI: Suorituslajityyppi-SV: Typ nr. norm.	EN: Unit-FR: Unité-CS: Jednotka-DE: Einheit-ES: Unidad-IT: Unità-PT: Unidade-SK: jednotka-EL: Μονάδα-FI: Yksikö-EN: Type norme-FR: Type norme-CS: Model-DA: Normtype-DE: Typ-ES: Modelo-IT: Tipo di norma-SK: Stanovitný typ-EL: Τύπος/νομοτύπος-FI: Suorituslajityyppi-SV: Typ nr. norm.	EN: Unit-FR: Unité-CS: Jednotka-DE: Einheit-ES: Unidad-IT: Unità-PT: Unidade-SK: jednotka-EL: Μονάδα-FI: Yksikö-EN: Type norme-FR: Type norme-CS: Model-DA: Normtype-DE: Typ-ES: Modelo-IT: Tipo di norma-SK: Stanovitný typ-EL: Τύπος/νομοτύπος-FI: Suorituslajityyppi-SV: Typ nr. norm.	EN: Unit-FR: Unité-CS: Jednotka-DE: Einheit-ES: Unidad-IT: Unità-PT: Unidade-SK: jednotka-EL: Μονάδα-FI: Yksikö-EN: Type norme-FR: Type norme-CS: Model-DA: Normtype-DE: Typ-ES: Modelo-IT: Tipo di norma-SK: Stanovitný typ-EL: Τύπος/νομοτύπος-FI: Suorituslajityyppi-SV: Typ nr. norm.	EN: Unit-FR: Unité-CS: Jednotka-DE: Einheit-ES: Unidad-IT: Unità-PT: Unidade-SK: jednotka-EL: Μονάδα-FI: Yksikö-EN: Type norme-FR: Type norme-CS: Model-DA: Normtype-DE: Typ-ES: Modelo-IT: Tipo di norma-SK: Stanovitný typ-EL: Τύπος/νομοτύπος-FI: Suorituslajityyppi-SV: Typ nr. norm.
--	--	---	---	---	---	---	---	---	---	---	---	---	---	---	---	---	---	---



FR

CS

DA

DE

EL

EN

ES

FI

IT

NL

NO

PL

PT

SK

SV

Brandt



GEBRUIKERSINSTRUCTIES NL

OVN

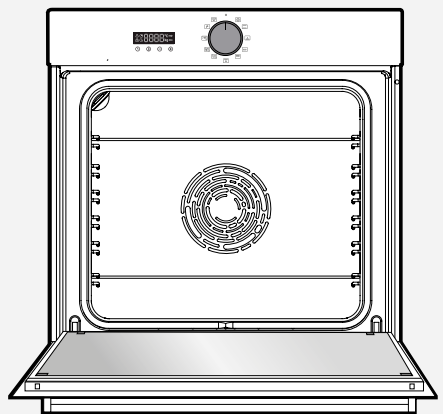

BYCert.6011825

Geachte klant,

U heeft zojuist een **BRANDT** gekocht; wij danken u dan ook voor uw vertrouwen in onze producten.

We hebben dit product ontworpen en geproduceerd met uzelf, uw levenswijze en uw noden in ons achterhoofd om ervoor te zorgen dat het zo goed mogelijk aan uw verwachtingen voldoet. U vindt er onze knowhow, onze innoveringsgeest en alle passie in terug die ons al meer dan 60 jaar drijft.

Aangezien we er voortdurend naar streven zo goed mogelijk te beantwoorden aan uw eisen, staat onze klantendienst geheel te uwer beschikking en biedt ze u een luisterend oor voor al uw vragen of suggesties.

Kijk ook op onze site **www.brandt.com** daar vindt u al onze producten en nuttige en aanvullende informatie.

BRANDT is verheugd om u dagelijks te begeleiden en wenst u heel veel plezier met uw aankoop.

	<p>Het label "Origine France Garantie" biedt de consument de traceerbaarheid van een product door een duidelijke en objectieve aanduiding van de oorsprong te geven. Het merk BRANDT is er trots op dit label aan te brengen op producten van onze Franse fabrieken in Orléans en Vendôme.</p>
--	--

<https://brandt.fr/>

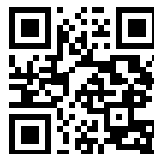

Belangrijk:

Lees deze handleiding aandachtig door voordat u uw apparaat inschakelt, zodat u sneller vertrouwd raakt met de bediening.



VEILIGHEIDSINSTRUCTIES	4
MILIEU EN ENERGIEBESPARING	6
Omgeving	6
Energiebesparende tip	6
UW APPARAAT INSTALLEREN	7
Keuze van locatie en installatie	7
Elektrische aansluiting	8
BESCHRIJVING VAN UW APPARAAT	9
Presentatie van de oven	9
Display- en bedieningstoetsen	9
Accessoires	10
Uw apparaat gebruiken	12
Instellingen	12
Instellingenmenu	13
Kookmodi	14
Beginnen met koken	15
UW APPARAAT ONDERHOUDEN	17
Binnen- en buitenreiniging	18
ANOMALIEËN EN OPLOSSINGEN	19
DIENST NA VERKOOP	21
Interventies	21
KOOKHULP	21
Kookschema's	22
Recepten met gist	24
Functionele proeve van bekwaamheid	25
Functies met automatische gecombineerde stoom	26



BELANGRIJKE VEILIGHEIDSINSTRUCTIES - LEES ZE AANDACHTIG EN BEWAAR ZE VOOR TOEKOMSTIG GEBRUIK.

U kunt deze handleiding downloaden op de website van het merk.

Pak na ontvangst het toestel uit of laat dit onmiddellijk uitpakken. Controleer het algemeen aanzicht. Laat eventuele opmerkingen noteren op de vrachtbrief waarvan u een kopie bewaart.

Belangrijk:

Dit apparaat mag worden gebruikt door kinderen vanaf 8 jaar, en door personen met lichamelijke, sensorische of geestelijke beperkingen of door personen zonder ervaring en kennis, als ze onder toezicht staan of vooraf instructies gekregen hebben over hoe ze het apparaat veilig moeten gebruiken, en begrepen hebben aan welke risico's ze zich blootstellen.

— Kinderen mogen niet met het apparaat spelen. Schoonmaak en gebruikersonderhoud mogen niet worden uitgevoerd door kinderen zonder toezicht

— Laat kinderen nooit onbewaakt, om te vermijden dat ze met het apparaat zouden spelen.

WAARSCHUWING:

— Het apparaat en de bereikbare onderdelen worden warm tijdens het gebruik. Wees voorzichtig de verwarmingselementen binnen in de oven niet aan te raken. Kinderen jonger dan 8 moeten worden weggehouden tenzij ze onder permanent toezicht staan

— Dit apparaat is ontworpen voor gebruik met gesloten deur.

— Voordat u een pyrolyscleaning van uw oven uitvoert, moet u eerst alle accessoires en de belangrijkste vlekken verwijderen. — In de reinigingsmodus kunnen de oppervlakken warmer worden dan tijdens het normale gebruik. Het is raadzaam om kinderen weg te houden.

— Gebruik geen stoomreiniger.

— Geen schuurmiddelen of harde metalen krabbers gebruiken om de glazen deur van de oven schoon te maken. Deze kunnen krassen op het oppervlak en breuk van het glas veroorzaken.



LET OP :

Verzekeer u ervan dat het apparaat van het elektriciteitsnet is afgekoppeld voordat u de lamp vervangt, om elk elektrocutiegevaar te vermijden. Wacht tot het apparaat afgekoeld is. Gebruik een rubberen handschoen om het losschroeven van het vensterkapje en het lampje te vereenvoudigen.

Het stopcontact moet na de installatie goed bereikbaar zijn. Het apparaat moet van het elektriciteitsnet kunnen worden afgekoppeld, door middel van een stekker in het stopcontact of door een schakelaar te installeren op de vaste voedingsleidingen, volgens de installatieregels.

— Indien de voedingskabel is beschadigd, moet deze door de fabrikant, de klantenservice of een ander gekwalificeerd persoon veiligheidshalve worden vervangen.

— Dit apparaat kan zowel onder het werkblad als in een inbouwkast worden geïnstalleerd, zoals te zien is op het installatieschema.

— Centreer de oven in het meubel en bewaar daarbij een afstand van minstens 10 mm tot het meubel ernaast. Het

materiaal van het inbouwmeubel moet warmtebestendig zijn (of bekleed zijn met dergelijk materiaal). Bevestig de oven voor meer stabiliteit in het meubel met behulp van 2 schroeven door de daartoe voorziene gaten.

— Het apparaat mag niet achter een decoratieve deur worden geplaatst, om oververhitting te voorkomen.

— Dit apparaat is bestemd voor huishoudelijk en vergelijkbaar gebruik, zoals: keukenhoeken voor het personeel in magazijnen, kantoren en andere beroepsomgevingen; boerderijen, gebruik door klanten van hotels, motels en andere woonomgevingen; omgevingen zoals bed and breakfasts.

— Voor alle reiniging van de oven, moet de oven uitgeschakeld zijn.

Wijzig de eigenschappen van dit apparaat niet, dit kan gevaarlijk voor u zijn.

Gebruik uw oven niet als voorraadkast of opslag na gebruik.



RESPECT VOOR HET MILIEU

Het verpakkingsmateriaal van dit apparaat is recyclebaar. Doe mee aan de recycling en draag bij aan de bescherming van het milieu door dit materiaal in de hiervoor bestemde gemeenteccontainers te deponeren.



Uw apparaat bevat eveneens tal van recyclebare materialen. Daarom is het voorzien van dit logo wat aangeeft dat de gebruikte apparaten van ander afval dienen te worden gescheiden.

De recyclage van de apparaten die door uw fabrikant wordt georganiseerd, wordt op deze manier onder de beste omstandigheden uitgevoerd, overeenkomstig de Europese richtlijn 2002/96/CE betreffende elektrisch en elektronisch afval.

Informeer bij uw gemeente of bij uw verkoper naar de dichtstbijzijnde inzamelplaats voor uw oude apparaten.

Wij danken u voor uw bijdrage aan de bescherming van het milieu.

ENERGIEBESPARENDE TIP

Houd tijdens het koken de oven deur gesloten.



KEUZE VAN DE PLAATSING EN INBOUW

De schema's bepalen de afmetingen van een meubel waarin uw oven past.

Dit toestel kan zonder onderscheid onder een werkvlak **(A)** of in kolom **(B)**, geplaatst worden. Als de behuizing open is, mag de opening aan de achterzijde maximaal 70 mm zijn. **(C et D)**. Maak de oven vast in het meubel. Verwijder hiervoor de rubber blokjes en boor een gat van $\varnothing 2$ mm voor in de wand van het meubel om te voorkomen dat het hout barst. Maak de oven met 2 schroeven vast. Zet de rubber blokjes terug.



Advies

Om er zeker van te zijn dat u een conforme installatie heeft, doet u best een beroep op een specialist in huishoudtoestellen.



Waarschuwing:

Als de elektrische installatie in uw huis aanpassingen vereist om uw apparaat aan te sluiten, bel dan een gekwalificeerde electricien. Als de oven een afwijking vertoont, trek dan de stekker uit het stopcontact of verwijder de zekering die overeenkomt met de ovenaansluitkabel.

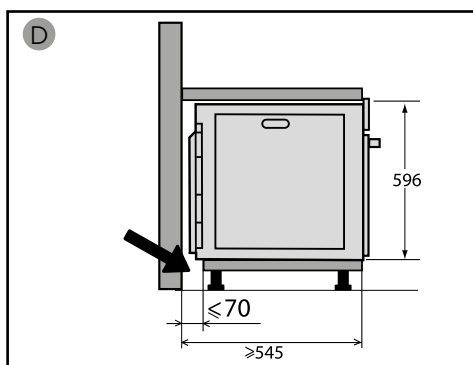
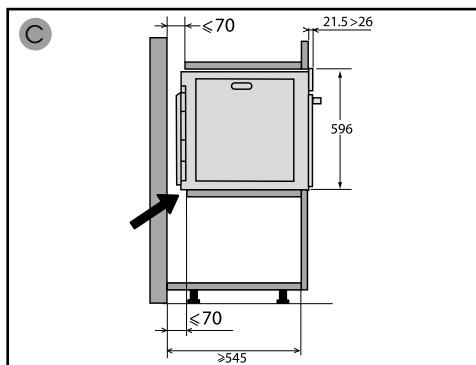
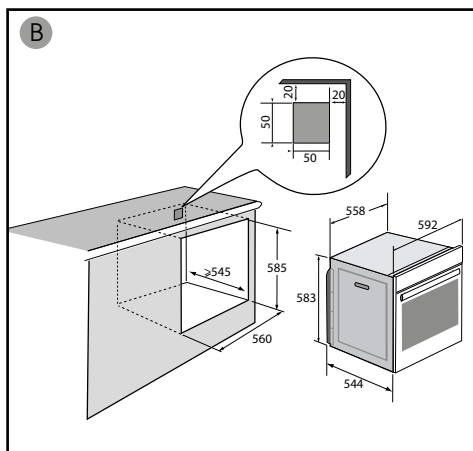
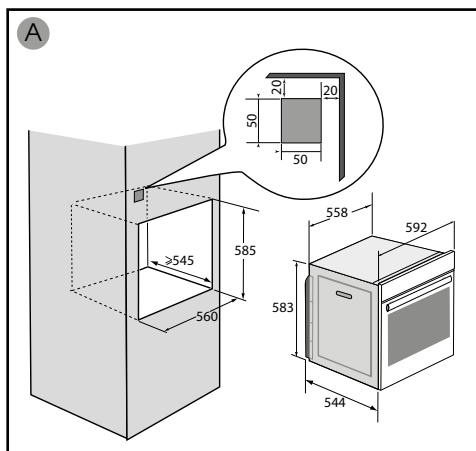



ELEKTRISCHE VERBINDING

Uw oven moet aangesloten worden met een voedingskabel (genormaliseerd) met 3 geleiders van 1,5 mm² (1f + 1N + aarding) die aangesloten worden op het elektriciteitsnet van 220-240V_~ monofasig via een genormaliseerd stopcontact 1f + 1 neutraal + aarding overeenkomstig de norm CEI 60083 of een omnipolaire schakelaar of overeenkomstig de installatievoorschriften.

Waarschuwing

De beschermingsdraad (groen-geel) is verbonden met de aansluitklem  an het apparaat en moet worden verbonden met de aarding van de installatie. De zekering van uw installatie moet 16 ampère zijn

LET OP

De uitschakeling wordt bekomen door een toegankelijke stroomkabel te voorzien of door een schakelaar te plaatsen op de vaste leiding die voldoet aan de installatieregels.

• **voor het eerste gebruik**

Verwarm de oven voordat je hem voor het eerst gebruikt, hem leeg, met de deur gesloten, ongeveer 15 minuten op de hoogste temperatuur, om het apparaat in te breken. De minerale wol die de ovenruimte omgeeft, kan door zijn samenstelling aanvankelijk een bepaalde geur afgeven. Evenzo kunt u rook opmerken. Dit is allemaal normaal.

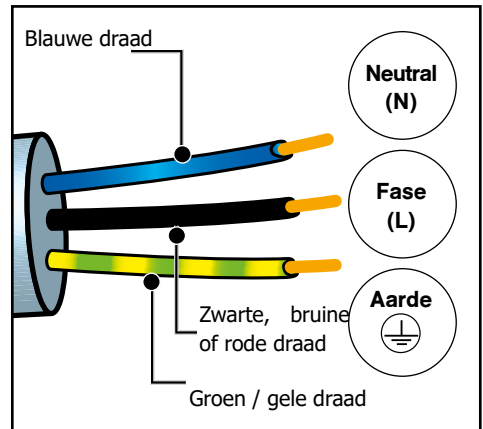



Voorstelling van de oven

VOORSTELLING VAN DE OVEN

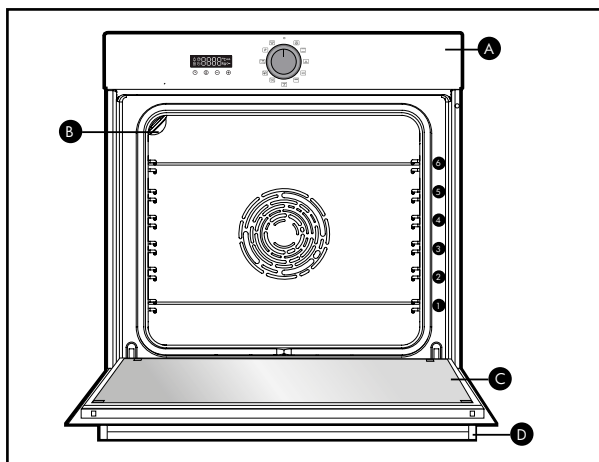

- A** Bedieningspaneel
- B** Lamp
- C** Deur
- D** Handgreep

Deze oven heeft 6 niveaus voor de accessoires: niveau 1 t/m 6.

• Weergave



- Baktijd
- Einde baktijd
- Vergrendeling toetsenbord
- Timer
- Temperatuurindicator
- Indicator voorverwarming
- Deurvergrendeling

• Toetsen

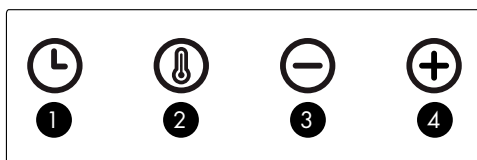

- 1** Instelling van tijd en duur
- 2** Instelling temperatuur
- 3** Toets -
- 4** Toets +



ACCESSOIRES

• Rooster met kantelbeveiliging

Het rooster kan gebruikt worden om alle borden en vormen met te bakken of te gratineren voedingswaren op te zetten. Het zal voor gegrilde gerechten gebruikt worden (die er rechtstreeks op mogen staan).

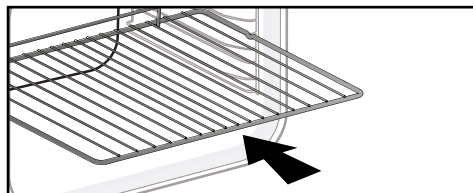

• Plaat voor multigebruik met lekbak 45 mm

Geplaatst in de roosterinkepingen met de handgreep naar de ovendeur gericht. Deze dient om sap en vet van gegrilde gerechten op te vangen en kan half met water gevuld worden voor de bain-marie bereidingen.

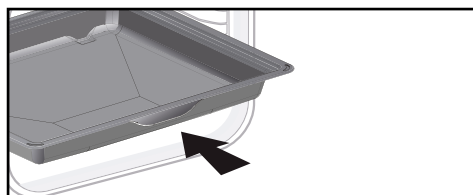

• Patisserieplaat 20 mm

Geplaatst in de inkepingen met de handgreep naar de ovendeur gericht. Ideaal voor het bakken van cookies, zandkoekjes, cupcakes. Met de schuine zijde kunt u eenvoudig uw bereidingen op een schaal leggen. Kan ook in de roosterinkepingen geplaatst worden om het bakvocht en vet van gegrilde gerechten op te vangen.

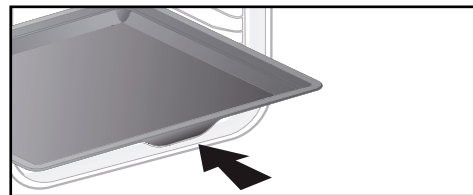

• Systeem van schuifrails

Met het schuifrailsysteem wordt het praktischer en gemakkelijker om voedsel te hanteren aangezien de platen zachtjes uitgehaald kunnen worden wat hun gebruik maximaal vereenvoudigt. De platen kunnen volledig uitgehaald worden waardoor men er een volledige toegang toe heeft.

Daarenboven zorgt hun stabiliteit ervoor dat voedsel in alle veiligheid bewerkt en gehanteerd kan worden, wat het risico op brandwonden vermindert. Zo kunt u het voedsel veel gemakkelijker uit de oven halen.

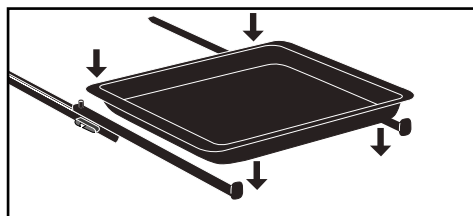

Let op:

Verwijder de accessoires en de planken uit de oven voordat u met pyrolyse begint.

Advies

Als gevolg van de warmte kunnen de accessoires vervormen, maar dit heeft geen enkele invloed op hun functie. Zodra zij afkoelen, krijgen zij hun originele vorm weer terug.



Voorstelling van de oven

INSTALLATIE EN DEMONTAGE VAN DE SCHUIFRAILS

Kies na de 2 niveauhouders verwijderd te hebben de hoogte (2 tot 5) waarop u uw rails wilt bevestigen. Plaats de linker rail tegen het linker niveau en druk daarbij stevig op de voor- en achterkant van de rail, zodat de 2 lipjes aan de zijkant van de rail in de niveauhouder geklikt worden. Ga op dezelfde wijze te werk voor de rechter rail.

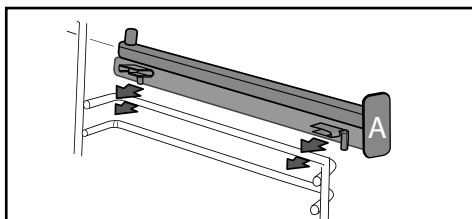

N.B.: het uitschuifbare schuifgedeelte van de rail moet naar de voorkant van de oven uitgeklapt worden, het blokje **A** bevindt zich tegenover u.

Plaats uw 2 niveauhouders en plaats daarna uw plaat op de 2 rails, het systeem is klaar voor gebruik..

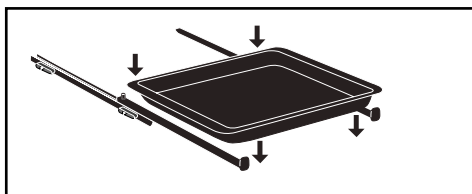

Verwijder opnieuw de niveauhouders om de rails te demonteren.

Schuif de op iedere rail bevestigde lipjes enigszins naar beneden om ze uit het niveau te halen. Trek de rail naar u toe.

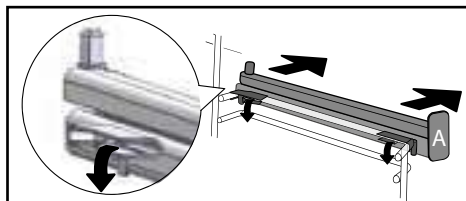

Advies :

Om te voorkomen dat er dampen vrijkomen bij het bereiden van vet vlees, raden we aan om een kleine hoeveelheid water of olie op de bodem van de pan te doen.





Gebruik van uw toestel

INSTELLINGEN

• Inschakeling van de tijd

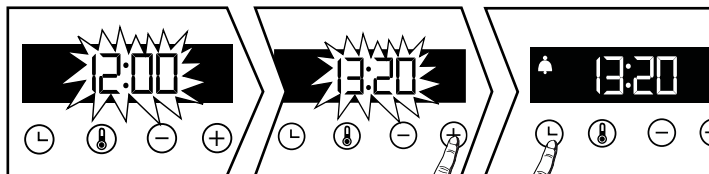
Bij het opstarten knippert het scherm op 12:00.





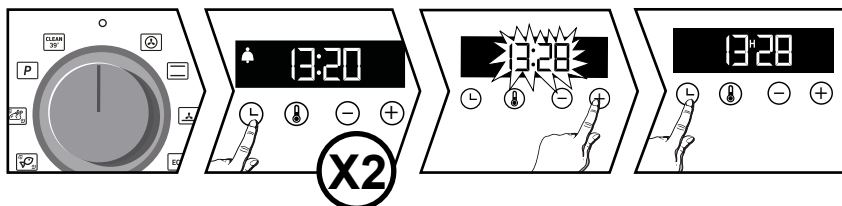

Stel de tijd in met de toetsen + of -. Bevestig met de toets . Bij een stroomonderbreking knippert de weergave van de tijd.

• Wijziging van de tijd

De functiekeuzeknop moet verplicht op de stand 0 staan.



Druk op de toets  het symbol  verschijnt druk opnieuw op . Verander de instelling van de tijd met de toetsen + of -. Bevestig met de toets . Het registreren van de veranderde tijd gaat automatisch, na enkele seconden.

• Timer

Deze functie kan alleen gebruikt worden wanneer de oven uit staat.

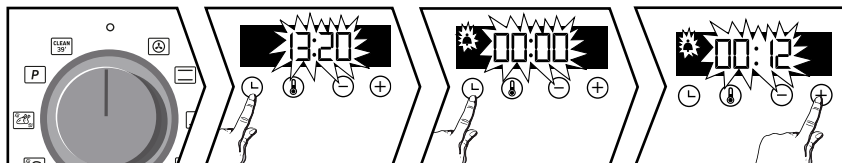

De functiekeuzeknop moet verplicht op de stand 0 staan. Druk op de toets  Het symbol  knippert.

Stel de timer in met de toetsen + en -.



Druk op de toets  om te bevestigen, het aftellen begint.

NB: Het is mogelijk om op elk gewenst moment de timerprogrammering te wijzigen of te annuleren. Ga voor het annuleren terug naar het menu van de timer en stel deze af op 00:00. Zonder bevestiging vindt het registreren automatisch na enkele seconden plaats

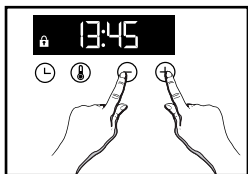

• Vergrendeling toetsenbord





Druk tegelijkertijd op de toetsen + en - totdat het symbool  wordt weergegeven op het scherm. Druk voor het ontgrendelen tegelijkertijd op de toetsen + en - totdat het symbool  van het scherm verdwijnt.

INSTELLINGEN

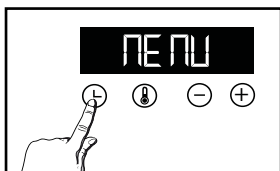

U kunt diverse parameters van uw oven zelf instellen, ga daarvoor als volgt te werk:

Druk op de toets  totdat "MENU" wordt weergegeven, om toegang te krijgen tot de instellingsmodus.



Druk opnieuw op de toets  om de verschillende instellingen door te lopen.

Schakel met de toetsen met + en - de verschillende parameters in of uit, zie onderstaande tabel:

	AUTO: Bij de bakmodus dooft de lamp in de ovenruimte na 90 seconden ON: Bij de bakmodus blijft de lamp doorlopend branden.
	De pieptonen van de toetsen in-/uitschakelen
	De demonstratiemodus in-/uitschakelen
	De voorverwarmingsmodus in-/uitschakelen

Druk voor het verlaten van het "MENU" opnieuw op .



Gebruik van uw toestel

BAKWIJZEN

Handmatige functies :



HETELUCHTFUNCTIE*

Temperatuur, min. 35°C, max. 250°C

Aanbevolen voor om wit vlees, vis en groenten mals te houden. Voor meerdere bakbeurten tot 3 niveaus.



TRADITIONEEL

Temperatuur, min. 35°C, max. 275°C

Aanbevolen voor langzaam, zacht bakken: zacht wild. Om rollade van rood vlees aan te braden. Voor het laten sudderen van gesloten ovenschalen die eerder zijn gestart op de kookplaat (coq au vin, stoofpot).



GEPULSTE BODEM

Temperatuur, min. 75°C, max. 250°C

Aanbevolen voor vochtige gerechten (quiches, taart van sappig fruit, enz.). Het deeg wordt onderaan goed gebakken. Aanbevolen voor bereidingen die rijzen (cake, brioche, kouglof (tulbandgebak)...) en soufflés die niet worden geblokkeerd door een korst aan de bovenzijde.



ECO*

Temperatuur, min. 35°C, max. 275°C

Met deze positie wordt energie bespaard terwijl de kookkwaliteiten behouden blijven.

Alle bakwijzen gebeuren zonder voorverwarmen.



KRACHTIGE GRILL

Temperatuur, min. 180°C, max. 275°C

Aanbevolen om toast te roosteren, gerechten te gratineren, crème brûlée van een goudbruin korstje te voorzien...



GRILL PULS

Temperatuur, min. 100°C, max. 250°C

Gevogelte en rollade zijn sappig en krokant gebakken aan alle kanten.

Schuif de lekbak in het onderste niveau.

Aanbevolen voor alle gevogelte en gebraad, om lam aan te braden en goed uit te bakken, runderribben. Om vissteaks sappig te houden.

Automatische functies:

Brandt biedt u 3 nieuwe functies die automatisch twee bereidingswijzen met elkaar combineren: traditioneel bereiden en bereiden met stoom, zodat de voedingskwaliteiten van de voedingsmiddelen behouden blijven en het gerecht sneller klaar is.



WIT VLEES

Aanbevolen om varkens- en kalfsgebrad mals en sappig te houden.



VIS

Aanbevolen voor het bereiden van hele vis en visfilets.



GEVOGELTE

Aanbevolen voor het bereiden van kip, kalkoen, parelhoen en eend.

Voor deze 3 functies hoeft u alleen maar een voldoende hoeveelheid water in uw schaal (lekbak) te doen en deze in uw oven op het lage niveau te plaatsen, en het voedingsmiddel op niveau 3 te plaatsen.

Zie voor de in de lekbak te schenken hoeveelheid water de tabel met de automatische combi-functies met stoom aan het einde van de handleiding.



Functie "Smart Assist"

Uw oven is voorzien van de functie "SMART ASSIST" die tijdens het programmeren van de tijdsduur u een veranderbare baktijd aanbeveelt aan de hand van de gekozen bakwijze.

**Bakwijze volgens de aanbevelingen van de norm EN 60350-1: 2016 om aan te tonen dat wordt voldaan aan de eisen van de Europese verordening EU/65/2014 inzake energie-etiketten.*



ONMIDDELIJK BAKKEN

• Direct beginnen met koken

Le programmateur ne doit afficher que l'heure. Celle-ci ne doit pas clignoter. Tournez le sélecteur de fonctions sur la position de votre choix.

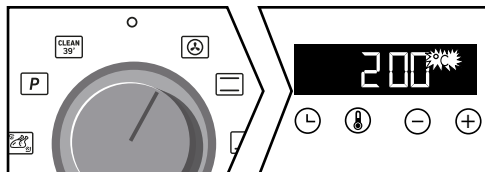



Voor de handmatige functies:

De temperatuur begint onmiddellijk te stijgen. Uw oven beveelt een temperatuur aan, die u kunt veranderen. De oven verwarmt en de temperatuurindicator knippert. Een reeks geluidssignalen weerklinkt wanneer de oven de geprogrammeerde temperatuur bereikt.

Voor de automatische functies:

 wordt weergegeven op het scherm.

Selecteer uw voedingsmiddel met behulp van de tabel aan het einde van de handleiding. Druk op de toetsen + en - totdat u het gewenste schema op de display bereikt en valideer daarna met de toets .

Een gewicht knippert; voer het werkelijke gewicht van uw voedingsmiddel in met de toetsen + en - en valideer daarna .

U hoeft niets in te stellen, de temperatuur en de bereidingstijd worden automatisch berekend. De eindtijd van de bereiding knippert, valideer met de toets . Het bereiden gaat onmiddellijk van



• Wijziging van de temperatuur

Druk op .

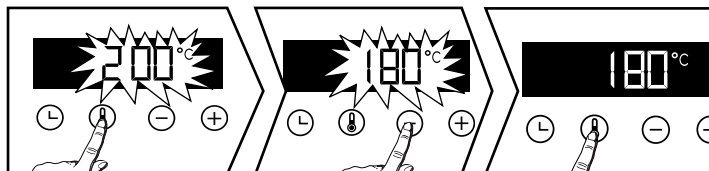
Stel de temperatuur bij met + of -. Bevestig door op  te drukken.



• Wijziging van duur

Kook onmiddellijk en druk op , de kooktijd  knippert, instelling is mogelijk. Druk op + of - om de kooktijd in te stellen.

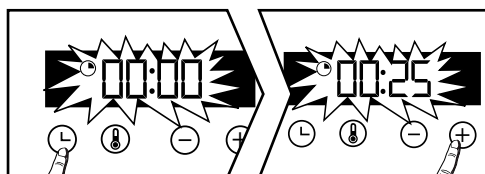



Functie "Smart Assist"

Uw oven is voorzien van de functie "SMART ASSIST" die tijdens het programmeren van de tijdsduur u een veranderbare baktijd aanbeveelt aan de hand van de gekozen bakwijze.

Zie onderstaande tabel:

De registratie van de kooktijd gebeurt automatisch in een paar seconden. Het aftellen van de tijdsduur begint zodra de baktemperatuur bereikt is.

BAK- FUNCTIE	AANBEVOLEN TIJDEN
	30 min
	30 min
	30 min
ECO	30 min
	7 min
	15 min

• Bakken met uitgestelde start

Procedure zoals bij de geprogrammeerd tijdsduur. Druk na het instellen van de baktijd op de toets , de tijd van het einde van het bakken knippert .

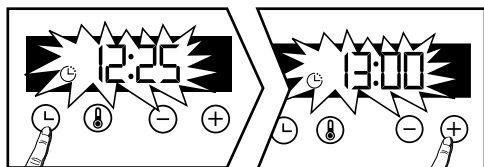

De weergave knippert, stel de tijd van het einde van de baktijd in met + of -.

De registratie van het einde van de baktijd gebeurt automatisch in een paar seconden. Het display met kookeinde stopt met knipperen.



INTERIEUR - EXTERIEUR REINIGEN

• Reiniging van de holte door pyrolyse





Opgelet

Verwijder de accessoires en de niveauhouders van de oven alvorens een reiniging d.m.v. pyrolyse te starten. Verwijder alvorens over te gaan tot een reiniging door pyrolyse eventueel ontstane grote vlekken. Verwijder vetvlekken op de deur met behulp van een vochtige spons.

Als veiligheidsmaatregel wordt de reiniging door pyrolyse pas uitgevoerd na automatische vergrendeling van de deur, deze kan dan niet ontgrendeld worden.

• Onmiddellijke automatische reiniging

De programmakiezer moet het uur van de dag weergeven, zonder knipperen. Selecteer een van de automatische reinigingscycli met de functieknop  of  :

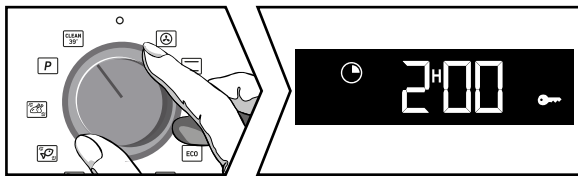



 = Reiniging in **39 minuten**

- Aan het einde van iedere bereiding verschijnt "Clean 39" op het scherm met het voorstel deze reiniging te starten. Zet de knop op deze functie en valideer met de toets . De tijdsduur 0:39 wordt weergegeven, afgewisseld met "Clean 39", het reinigen gaat van start. Na enkele minuten verschijnt er een sleutel, de deur van de oven wordt dan als veiligheidsmaatregel tijdens het hele programma vergrendeld.

Als u een "Clean 39" wilt starten met een koude of onvoldoende verwarmde oven, laten de startvoorwaarden van het programma deze reiniging niet toe. 0:00 wordt weergegeven op het scherm, u moet dan de andere positie van de automatische reiniging  kiezen.

 = **Pyrolyse van 2 uur**. Zet de knop op deze functie.



Zet de knop op deze functie.  wordt weergegeven op het scherm. Druk op + om uw pyrolyse te kiezen aan de hand van de vuilheidsgraad van uw oven.

Aan de hand van uw keuze wordt de tijdsduur 2:00 weergegeven. Bevestig met de toets .  wordt weergegeven, de pyrolyse start.

Aan het einde van de reiniging geeft het display 0:00 weer en ontgrendelt de deur.

Zet de functieschakelaar terug op 0.

• Automatische reiniging op een later moment

U kunt het starten van de Pyrolyse instellen voor een later moment. Wanneer de tijdsduur van het programma wordt weergegeven op het scherm, drukt u op de toets  en stelt u de nieuwe eindtijd in met de toetsen + en -, waarna u valideert met . Het automatisch reinigen start later en eindigt op de nieuwe geprogrammeerde tijd. Zet aan het einde van het reinigen de functieschakelaar terug op 0.



- **Reinigen van het buitenoppervlak**

Gebruik een zachte, vochtige doek met glasreiniger. Gebruik geen schuurmiddelen noch harde spons.

- **Reiniging van de draadstandaarden**

Demonteer de stappendraden om ze schoon te maken. Til het voorste deel van de step omhoog; duw de hele trede omhoog en maak de voorste haak uit zijn behuizing. Trek vervolgens de hele trede lichtjes naar u toe om de achterste haken uit hun behuizing te halen. Verwijder de 2 treden.

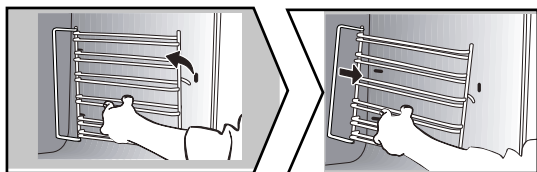

- **Het deurglas schoonmaken**



Let op

Geen schuurmiddelen, schuursponzen of metalen krabbers gebruiken om de glazen deur van de oven schoon te maken. Deze kunnen krassen op het oppervlak en breuk van het glas veroorzaken.

Verwijder eerst het overtollige vet van de binnenruit met een zachte doek en afwasmiddel. Om de verschillende binnenruiten te reinigen, gaat u als volgt te werk:

- **Het deurglas schoonmaken**

Open de deur volledig en blokkeer deze met de plastic wig die is meegeleverd in de plastic zak van uw apparaat.

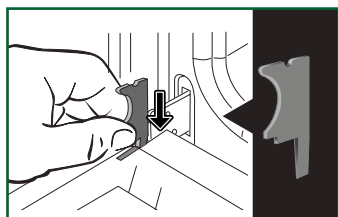

Verwijder de eerste geknipte ruit: druk met een stuk gereedschap (schroevendraaier) op de plaats (A) om de ruit los te klikken en verwijder hem.



Belangrijk:

Zorg ervoor dat u de montagerichting van dit 1e raam markeert (glanzende kant naar u toe)



Reiniging

Afhankelijk van het model bestaat de deur uit twee extra ruiten met op elke hoek een zwarte rubberen afstandhouder. Verwijder ze indien nodig om ze te reinigen.

Dompel de ramen niet onder in water. Afspoelen met schoon water en droogwrijven met een pluisvrije doek.

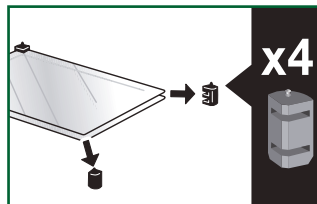
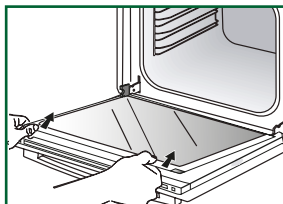
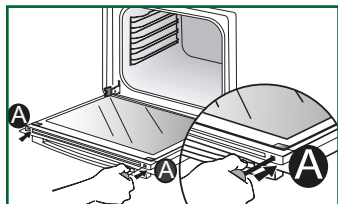

• De portieruiten terugplaatsen

Plaats na het reinigen de vier opwaartse pijlrubbers terug en verplaats de glasconstructie.

Steek de laatste ruit in de metalen aanslagen, klem hem dan met de glimmende kant naar u toe. Verwijder de plastic wig.

Uw apparaat is weer operationeel.

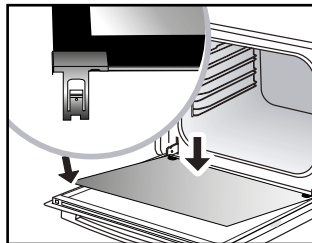
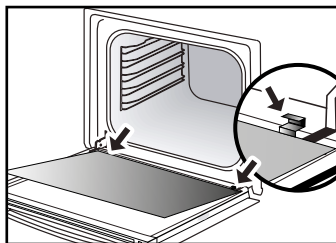
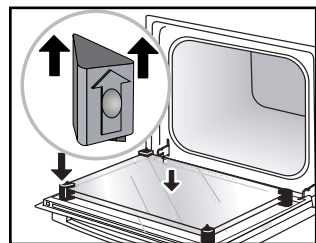

• Lamp vervangen



Let op

Zorg ervoor dat het apparaat is losgekoppeld van het stopcontact voordat u de lamp vervangt om het risico van een elektrische schok te voorkomen. Voer werkzaamheden uit wanneer het

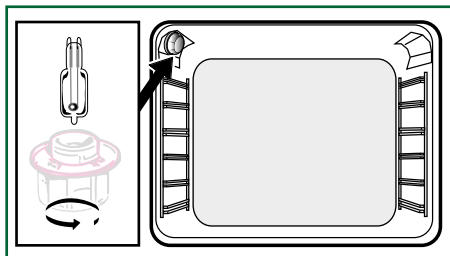

Eigenschappen van de gloeilamp:

25 W, 220-240 V~, 300°C, voet G9.

Gebruik om het venster en de lamp los te schroeven, een rubberen handschoen, die de demontage zal vergemakkelijken.



STORINGEN EN OPLOSSIN

De oven wordt niet warm.

Zorg ervoor dat de oven goed is aangesloten en controleer of de elektrische zekering niet is uitgeslagen. Verhoog de gekozen temperatuur.

De ovenlamp doet het niet.

Vervang lamp of zekering. Controleer of de oven correct is aangesloten..

De koelventilator blijft draaien als de oven is gestopt.

Dit is normaal, de ventilatie kan tot een uur na het koken werken om de binnen- en buitentemperatuur van de oven te verlagen. Neem langer dan een uur contact op met de klantenservice.

De pyrolyscleaning wordt niet uitgevoerd.

Controleer de sluiting van de deur. Als er een storing op de deurvergrendeling of temperatuursensor optreedt, bel de servicedienst.

Het symboolknippert op het display.

Deurslot defect, bel de servicedienst.

Trillend geluid.

Controleer of het netsnoer geen contact maakt met de achterwand.

Dit heeft geen invloed op de goede werking van uw toestel, maar kan tijdens het ventileren wel een trillend geluid veroorzaken. Verwijder uw apparaat en verplaats het snoer. Vervang je oven.



INTERVENTIES

Eventuele interventies aan uw toestel moeten worden uitgevoerd door een gekwalificeerde professionele technicus van het merk. Om bij het opbellen de verwerking van uw verzoek te vergemakkelijken, houdt de volledige referentie van uw toestel bij de hand (commerciële referentie, servicereferentie, serienummer). Deze informatie wordt weergegeven op het identificatieplaatje.

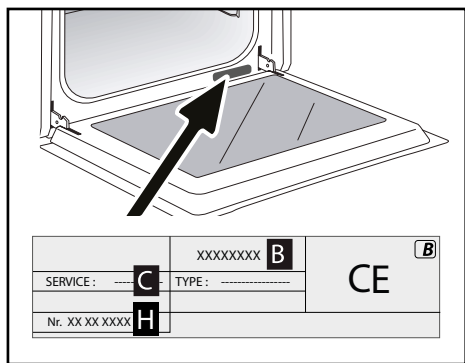

- B : Commerciële referentie
- C: Servicereferentie
- H: Serienummer

OORSPRONKELIJKE ONDERDELEN

Bij een onderhoudsgreep, dient u uitsluitend om oorspronkelijke onderdelen te vragen.





GERECHTEN	* * * * * * *												min	
Vlees														
Varkensgebraad (1kg)	200	2					180	2					60	
Kalfsgebraad (1kg)	200	2					180	2					60-70	
Rundergebraad	240	2											30-40	
Lamsvlees (bout, schouder 2,5 kg)	220	1			220					200	2		60	
Gevogelte (1 kg)	200	2			220		180	2			210	3	60	
Gevogelte, groot formaat	180	1											60-90	
Kippenbouten					220	3					210	3	20-30	
Varkens- / kalfsrib					210	3							20-30	
Rundribben (1kg)					210	3					210	3	20-30	
Schaapsribben					210	3							20-30	
Vis														
Geroosterde vis					275	4							15-20	
Gebakken vis (goudbrasem)	200	3					180	3					30-35	
Vis in folie	220	3					200	3					15-20	
Groenten														
Gegratineerde schotels (gare voedingsmiddelen)					275	2							30	
Gratins dauphinois	200	2					180	2					45	
Lasagne	200	3					180	3					45	
Gevulde tomaten	170	3					160	2					30	
Gebak														
Sponscake - Luchtige cake			180	2								180	2	35
Opgerolde cake	220	3										180	2	5-10
Brioche	180	1	210									180	2	35-45
Brownies	180	2					175	3						20-25
Cake - Evenveeltje	180	1	180	1								180	2	45-50
Kersenvlaai	200	2					180	3						30-35
Crèmes	165	2										150	2	30-40
Cookies - Zandkoekjes	175	3												15-20
Kugelhopf			180	2								180	2	40-45
Schuimgebak	100	2										100	3	60-70
Madeleines	220	3					200	3						5-10

* volgens model



GERECHTEN	* * * * * * * *												min	
Gebak														
Madeleines	220	3					200	3						5-10
Soezendeeg	200	3					180	3				180	3	30-40
Kleine bladerdeeghapjes	220	3					200	3						5-10
Savarin	180	3										175	3	30-35
Taart van kruimeldeeg	200	1					195	1						30-40
Taart van fijn bladerdeeg	215	1					200	1						20-25
Taart van gistdeeg	210	1					200	1						10-30
Diversen														
Spiesen	220	3			210	4								10-15
Pastei	200	2					190	2						80-100
Pizza van kruimeldeeg	200	2												30-40
Pizza van brooddeeg														15-18
Quiches														35-40
Soufflé												180	2	50
Taart met deegdeksel	200	2												40-45
Brood	220						200		220					30-40
Geroosterd brood	180				275	4-5								2-3
Stoofgerechten	180	2										180	2	90-180

* volgens model



Oven voorverwarmen tot de vermelde temperatuur.

Laat alle vlees minstens 1 uur op kamertemperatuur staan alvorens het in de oven te plaatsen.

THERMOSTAAT : CIJFER MET OVEREENSTEMMENDE GRADENWAARDE IN °C									
°C	30	60	90	120	150	180	210	240	275
CIJFER	1	2	3	4	5	6	7	8	9 maxi

Recept met gist (afhankelijk van het model)

Ingrediënten:

● Bloem 2 kg ● Water 1240 ml ● Zout 40 g ● 4 zakjes gedroogd bakpoeder

Meng het deeg met de mixer en laat het in de oven rijzen.

Procedure: Voor recepten van deeg met gist. Leg het deeg in een ovenvaste schaal, verwijder de niveauehouders en zet de schaal op de ovenbodem.

Verwarm de oven op de heteluchtfunctie voor op 40-50 °C gedurende 5 minuten. Schakel de oven uit en laat het deeg 25-30 minuten in de nog warme oven rijzen.





KEURINGSTESTS VOLGENS NORM IEC 60350













VOEDINGSMIDDEL	Bakwijzen	RICHEL	OPMERKINGEN	°C	TIJD	VOOR- VER- WAR- MING
Zandkoekjes (8.4.1)		5	Plaat 45mn	150	30-40	JA
Zandkoekjes (8.4.1)		5	Plaat 45mn	150	25-35	JA
Zandkoekjes (8.4.1)		2 + 5	Plaat 45mn + Rooster	150	25-45	JA
Zandkoekjes (8.4.1)		3	Plaat 45mn	175	25-35	JA
Zandkoekjes (8.4.1)		2 + 5	Plaat 45mn + Rooster	160	30-40	JA
Cakejes (8.4.2)		5	Plaat 45mn	170	25-35	JA
Cakejes (8.4.2)		5	Plaat 45mn	170	25-35	JA
Cakejes (8.4.2)		2 + 5	Plaat 45mn + Rooster	170	20-40	JA
Cakejes (8.4.2)		3	Plaat 45mn	170	25-35	JA
Cakejes (8.4.2)		2 + 5	Plaat 45mn + Rooster	170	25-35	JA
Zachte taart zonder vet (8.5.1)		4	Rooster	150	30-40	JA
Zachte taart zonder vet (8.5.1)		4	Rooster	150	30-40	JA
Zachte taart zonder vet (8.5.1)		2 + 5	Plaat 45mn + Rooster	150	30-40	JA
Zachte taart zonder vet (8.5.1)		3	Rooster	150	30-40	JA
Zachte taart zonder vet (8.5.1)		2 + 5	Plaat 45mn + Rooster	150	30-40	JA
Appeltaart (8.5.2)		1	Rooster	170	90-120	JA
Appeltaart (8.5.2)		1	Rooster	170	90-120	JA
Appeltaart (8.5.2)		3	Rooster	180	90-120	JA
Gegratineerde bovenzijde (9.2.2)		5	Rooster	275	3-6	JA

* volgens model

LET OP: Wanneer u bakt op 2 niveaus kunnen de bereidingen op verschillende tijdstippen uit de oven gehaald worden.



TABEL VAN DE AUTOMATISCHE COMBI-FUNCTIES MET STOOM

Stand van de knop	Weergave in de programmakiezer	Voedingsmid- delen	Hoeveelheid toe te voegen water
		Kip	500 ml lauw water in de lekbak
		Eend	500 ml lauw water in de lekbak
		Kalkoen	500 ml lauw water in de lekbak
		Parelhoen	800 ml lauw water in de lekbak
		Verse hele vis (groot)	500 ml lauw water in de lekbak
		Hele vis (plat)	300 ml lauw water in de lekbak
		Kleine hele vis	300 ml lauw water in de lekbak
		Visfilets	300 ml lauw water in de lekbak
			500 ml lauw water in de lekbak
		Kalfsgebraad	500 ml lauw water in de lekbak

BELANGRIJK

Plaats de lekbak (met lauw water) op het lage niveau 1 en het te bereiden voedingsmiddel op niveau 3.

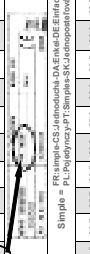

EN Informații pentru domeniul de aplicare (UE n° 6620/14)
DE Informationen zu Anwendungsbereich (UE n° 6620/14)
FR Informations concernant les fins d'application (UE n° 6620/14)
ES Información sobre los fines de aplicación (UE n° 6620/14)
CS Informační údaje ke záměru aplikace (UE n° 6620/14)
IT Informazioni relative al fine per cui sono destinati (UE n° 6620/14)
NL Informatie met betrekking tot het bestemmingsdoel (UE n° 6620/14)
DA Oplysninger for område til husefterskrivning (UE n° 6620/14)
SV Tillämpningsområde för avläsningsändamål (UE n° 6620/14)

EN	DE	FR	ES	CS	IT	NL	DA	SV
Information for domestic ovens (UE n° 6620/14)	Informationen zu Haushaltsbacköfen (UE n° 6620/14)	Informations pour fours domestiques (UE n° 6620/14)	Información sobre los hornos domésticos (UE n° 6620/14)	Informační údaje ke záměru aplikace (UE n° 6620/14)	Informazioni relative ai forni domestici (UE n° 6620/14)	Informatie met betrekking tot huishoudelijke ovens (UE n° 6620/14)	Oplysninger for ovne til husefterskrivning (UE n° 6620/14)	Tillämpningsområde för avläsningsändamål (UE n° 6620/14)
Symbol	Value							
Type norme	KH725V, KH725U, KH715P, KH725P, KH725T, KH725S, KXD25T, KXD25P	KH725W, KH725V, KH715W, KH725W, KH725V, KH715W, KH725W, KH725V, KXD25T, KXD25P	KH725W, KH725V, KH715W, KH725W, KH725V, KH715W, KH725W, KH725V, KXD25T, KXD25P	KH725W, KH725V, KH715W, KH725W, KH725V, KH715W, KH725W, KH725V, KXD25T, KXD25P	KH725W, KH725V, KH715W, KH725W, KH725V, KH715W, KH725W, KH725V, KXD25T, KXD25P	KH725W, KH725V, KH715W, KH725W, KH725V, KH715W, KH725W, KH725V, KXD25T, KXD25P	KH725W, KH725V, KH715W, KH725W, KH725V, KH715W, KH725W, KH725V, KXD25T, KXD25P	KH725W, KH725V, KH715W, KH725W, KH725V, KH715W, KH725W, KH725V, KXD25T, KXD25P
Models identification								
Type of oven	Simple	FR: Simple CS: Jednoduchá DA: Enkel DE: Einfach ES: Simple IT: Semplice NL: Simple PL: Prosta CZ: Jednoduchá SK: Jednoduchá						
Mass of the appliance	M	34,6 30,7 35,7 33,6 36,2 36,6 36,0 33,6 36,6 38,0 38,0 38,0 43,1						
Number of cavities		1 1 1 1 1 1 1 1 1 1 1 1 1						
Heat source per cavity (type of fuel or gas)	FR: Electricité CS: Elektrická DA: Elektrisk DE: Elektrisch ES: Eléctrico NL: Elektrisch-Electricity IT: Elettricità SK: Elektrická EL: Ηλεκτρική							
Volume per cavity	V	730 730 730 730 730 730 730 730 730 730 730 730 730						
Energy consumption (mode per cavity) required to heat a standardised load in a heated oven during a cycle in conventional mode per cavity (electric final energy)	EC 0,82 0,69 0,70 0,70 0,70 0,70 0,70 0,70 0,70 0,70 0,70 0,70							
Energy consumption (mode per cavity) required to heat a standardised load in a heated oven during a cycle in fan-forced mode per cavity (electric final energy)	EC 1,23 1,34 1,23							
Energy efficiency index per cavity	EEl	90,3 86,3 81,4 81,4 81,4 81,4 81,4 81,4 81,4 81,4 81,4 81,4						

FR

CS

DA

DE

EL

EN

ES

FI

IT

NL

NO

PL

PT

SK

SV

Brandt



BRUKSANVISNINGER NO

OVN

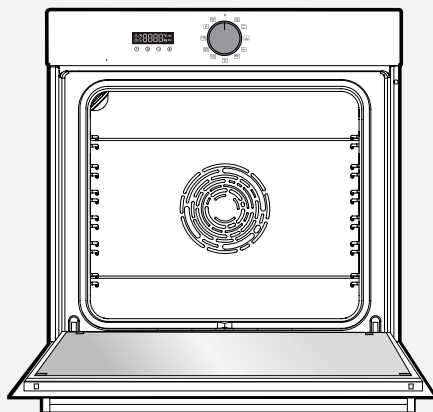

ORIGINE
FRANCE[®]
GARANTIE

BYCert.6011825

Kjære kunde

Du har nettopp kjøpt et produkt fra **BRANDT** og vi takker for tilliten til våre produkter.

Vi har designet og produsert dette produktet med tanke på deg, din livsstil og dine behov slik at den oppfyller dine forventninger. I dette produktet har vi tatt i bruk all vår ekspertise, vår innovasjonsånd og vårt engasjement som har ligget til grunn for vår virksomhet i over 60 år.

Da vi hele tiden ønsker å tilfredsstillе dine krav på best mulig måte, svarer vår kundeservice på alle dine spørsmål og tar imot forslag.

Besøk også vår hjemmeside www.brandt.com hvor du vil finne våre nyeste produkter, samt nyttig og utfyllende informasjon.

Det gleder BRANDT å være en del av din hverdag. Vi ønsker deg lykke til med ditt kjøp.



Etiketten "Origine France Garantie" gir forbrukerne sporbarheten til et produkt ved å gi en klar og objektiv indikasjon på opprinnelsen. **BRANDT**-merket er stolt av å påføre denne etiketten på produkter fra våre franske fabrikker med base i Orléans og Vendôme.

BVC cert. 6011825

<https://brandt.fr/>

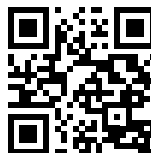

Viktig:

Før du tar i bruk apparatet, bør du lese denne installasjons- og brukshåndboken nøye for å gjøre deg raskere kjent med hvordan apparatet fungerer



SIKKERHETSINSTRUKSJONER	4
MILJØ	6
Respekt for miljøet	6
Energibesparende tips	6
INSTALLASJON	7
Valg av installasjonssted og innbygging	7
Elektrisk tilkobling	8
PRESENTASJON AV OVNEN	9
Presentasjon av ovnen	9
Display	9
Tilbehør	10
BRUKE ENHETEN	12
Innstillinger	12
Innstillingsmeny	13
Tilberedningsmodi	14
Starte matlaging	15
TA VARE PÅ ENHETEN DIN	17
Interiør - utvendig rengjøring	18
Avvik og løsninger	19
ETTERSALGSSERVICE	21
Intervensjoner	21
KOKEPLATER	21
Matlagingskart	22
Oppskrifter med gjær	24
Funksjonelle dyktighetstester	25
Funksjoner med automatisk kombinert damp	26



VIKTIGE SIKKERHETSINSTRUKSJONER. MÅ LESES NØYE OG OPPBEVARES FOR SENERE BRUK.

Denne brukerveiledningen kan lastes ned på nettstedet til merket.

Når apparatet mottas, pakk det ut eller få det pakket ut umiddelbart. Sjekk det generelle utseendet.

Ta eventuelt skriftlig forbehold på leveringseddelen som du beholder et eksemplar av.

Viktig:

Dette apparatet kan brukes av barn på minst 8 år og av personer med nedsatte fysiske, sensoriske eller psykiske evner, eller personer uten tilstrekkelig erfaring eller kunnskaper, så lenge de er under tilsyn eller får opplæring i å bruke dette apparatet på en sikker måte og de forstår risikoen det innebærer.

— Barn skal ikke leke med apparatet. Rengjøring og vedlikehold skal ikke utføres av barn uten tilsyn.

— Barn skal holdes under oppsyn for å sikre at de ikke bruker apparatet til lek.

ADVARSEL:

— Apparatet og de tilgjengelig delene på dette kan bli varme under bruk. Vær forsiktig og unngå å berøre varmeelementene inne i ovnen. Barn yngre enn 8 år bør

holdes på avstand, med mindre de ikke blir holdt øye med hele tiden.

— Dette apparatet er laget for steking og baking med lukket dør.

— Ta alt utstyr og tilbehør ut av ovnen og fjern det største sølet i ovnen før den rengjøres med pyrolyse.

— Når rengjøringsfunksjonen brukes, kan overflatene bli varmere enn ved vanlig bruk.

Det anbefales å holde barn på avstand.

— Ikke bruk et damprengjøringsapparat.

— Ikke bruk skuremidler eller harde metalliske skrapere for å rengjøre ovnens glassdør. Det kan skrape opp overflaten og føre til at glasset sprekker.

ADVARSEL :

For å unngå risiko for elektrisk støt må du sørge for at ovnen er koblet fra strømmettet før du skifter lyspære. Bytt lyspære når ovnen er avkjølt. Når du skal skru av lampens beskyttelsesglass og lyspæren, er det enklere å få bedre grep hvis du bruker gummihansker.

Stikkontakten må kunne nås etter at ovnen er installert. Det må



være mulig å frakoble apparatet fra strømmettet, enten ved hjelp av støpselet, eller ved å installere en bryter på de faststående rørene i samsvar med installasjonsreglene.

— Hvis strømledningen er skadet, må den av sikkerhetsmessige årsaker erstattes av produsenten, dens kundeservice eller av en person med lignende kvalifikasjoner.

— Dette apparatet kan installeres både under arbeidsbenken eller i et høyskap som forklart på installasjonstegningen.

— Sett ovnen i innredningen slik at det er minst 10 mm avstand mellom ovnen og skapet ved siden av. Innredningen som ovnen skal bygges inn i, må tåle høye temperaturer eller være belagt med et materiale som tåler høye temperaturer. For at ovnen skal bli så stabil som mulig, bør du montere den fast i innredningen med to skruer som skrues inn i hullene på sidestolpene.

— For å unngå overoppheting skal apparatet ikke installeres bak en pyntedør.

— Dette apparatet er beregnet til bruk i hjemmet og lignende steder, f.eks. i et kjøkken forbeholdt personalet i butikker, på kontorer og andre arbeidsplasser, på gårdsbruk, eller tilgjengelig for kunder

på hotell, motell og andre steder med hjemlig preg, eller på rom av typen bed & breakfast.

— Ovnen skal alltid slås av før den rengjøres innvendig.

Dette apparatets karakteristikk må av sikkerhetsmessige hensyn ikke endres.

Ikke bruk ovnen til oppbevaring av matvarer eller annet utstyr etter bruk.



RESPEKT FOR MILJØET

Dette apparatets emballasje kan resirkuleres. Bidra til gjenvinning av emballasjen og dermed til miljøvern, ved å sortere avfallet og kaste det i kommunale containere beregnet for dette.



Apparatet inneholder også mange resirkulerbare materialer. Derfor har det en logo som angir at gamle apparater ikke skal blandes med annet avfall.

Resirkuleringen av apparatet som utføres av fabrikanten, vil dermed gjennomføres på best mulig måte i samsvar med europeisk direktiv 2002/96/EF om avfall fra elektrisk eller elektronisk utstyr.

Ta kontakt med kommunen eller forhandleren for å få rede på innsamlingssteder for gamle apparater i nærheten av hjemmet ditt.

Takk for at du bidrar til miljøvern.

ENERGIBESPARENDE TIPS

Hold stekeovnsdøren lukket mens du lager mat.



VALG AV INSTALLASJONSSTED OG INNBYGGING

Tegningene ovenfor viser målene til innredningen som stekeovnen skal bygges inn i. Dette apparatet kan installeres både under arbeidsbenken (A) eller i et høyskap (B). Dersom innredningen er åpen, bør ikke åpningen bak være på mer enn 70 mm.

Fest ovnen i skapet. For å gjøre dette må du ta ut gummistopperne og forhåndsbore et hull med \varnothing 2 mm i skapveggen. Dette er for å unngå at treverket fliser seg opp. Skru fast ovnen med de 2 skruene. Sett tilbake gummistopperne



Råd

Ta gjerne kontakt med fagfolk for å forsikre deg om at monteringen er i overensstemmelse med gjeldende regler.



Advarsel:

Hvis den elektriske installasjonen i hjemmet ditt krever endringer for å koble til apparatet, må du ringe en kvalifisert elektriker. Hvis ovnen viser uregelmessigheter, må du koble fra apparatet eller fjerne sikringen som tilsvarer ovnens tilkoblingsledning.

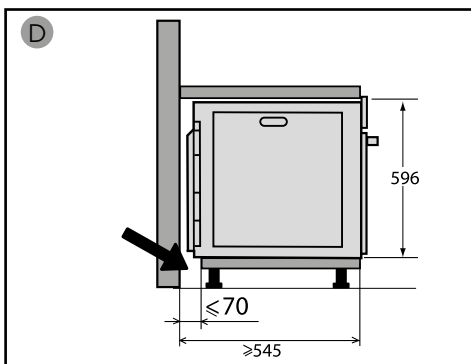
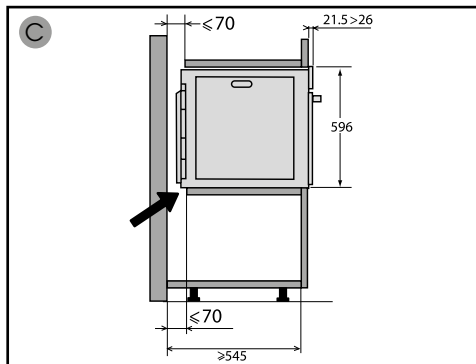
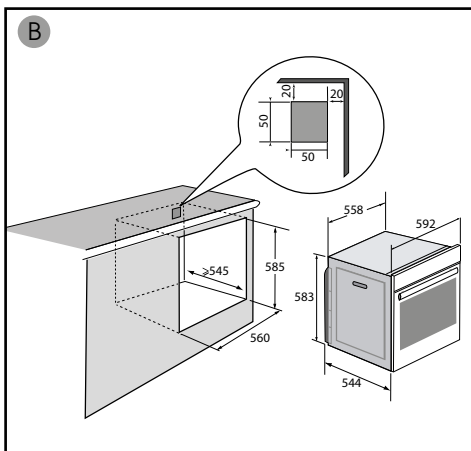
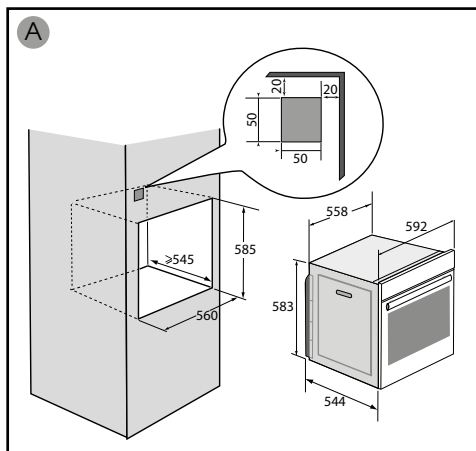



ELEKTRISK TILKOBLING

Ovnens må tilkobles med en standard treleders strømledning på 1,5 mm² (1 strømførende leder + 1 nulleleder + jord) som kobles til et strømnett på 220-240 V med en stikkontakt etter standard CEI 60083 eller en flerpolsbryter i henhold til gjeldende installasjonsregler.



Advarsel:

Jordledningen (gul-grønn) er koblet til ovnens tilkoblingsklemme, og må kobles til strømnettets jordsystem. Sikringen i det elektriske anlegget må være på 16 ampere.

Produsenten kan ikke holdes ansvarlig for ulykker eller hendelser som skyldes at ovnen er koblet til manglende, defekt eller feilaktig jording, eller som skyldes feilkobling.

• Før første gangs bruk

Før du bruker ovnen for første gang, må du varme den tom, med døren lukket, i omtrent 15 minutter på høyeste temperatur. for å bryte inn enheten. Mineralullen som omgir ovnshulen, kan i utgangspunktet avgi en spesiell lukt på grunn av sammensetningen. På samme måte kan du merke røyk. Alt dette er normalt.

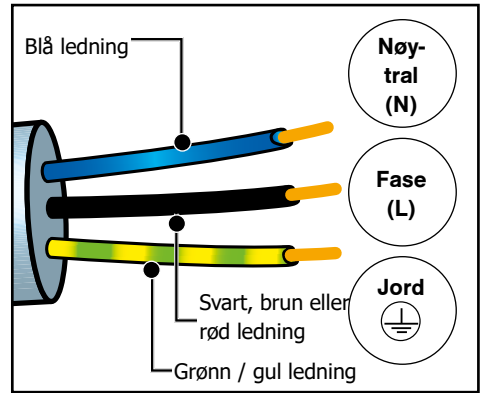



Presentasjon av ovnen

PRESENTASJON AV OVNEN

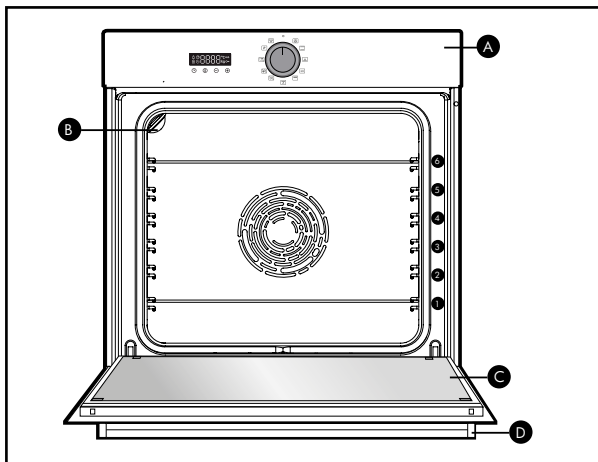

- A** Kontrollpanel
- B** Lampe
- C** Dør
- D** Håndtak

Denne ovnen har 6 rilleposisjoner for tilbehør: riller 1 til 6.

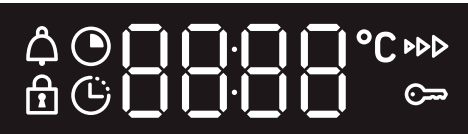

- Tilberedningstid
- Etter koking
- Tastelås
- Minuttnedtelling
- Temperaturindikator
- Indikator for forvarming
- Dørlås

• TASTER

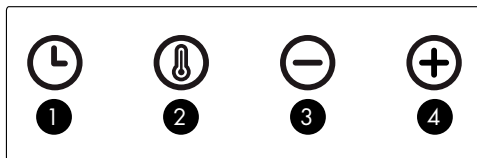

- 1** Innstille klokkeslett og varighet
- 2** Regulere temperaturen
- 3** Knapp -
- 4** Knapp +



TILBEHØR

• Sikkerhetsrist som hindrer velting

Risten kan brukes som underlag for alle slags former og brett med retter som skal stekes eller grilles. Den kan også brukes til grilling (matvarene legges rett på risten).

Sett inn risten med den forhøyde kanten innerst.

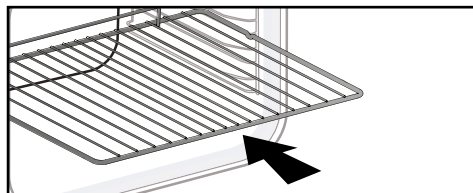

• Flerbrukspanne, langpanne 45mm

Settes inn i rillen under risten med håndtaket mot ovnsdøren. Pannen brukes til å samle opp kraft og fett fra grilling på risten. Den kan brukes halvfull med vann til vannbad.

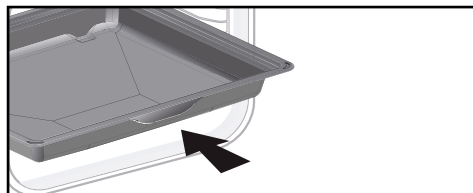

• Bakeplate, 20mm

Settes inn i rillen med håndtaket mot ovnsdøren. Perfekt for å steke småkaker, sandkaker, cupcakes. Skråplanet gjør det enkelt å legge matvarene i en panne eller form. Platen kan også settes i en av rillene under risten for å samle opp kraft og fett fra grilling.

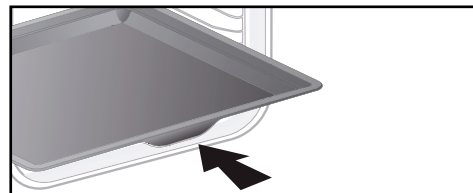

• Glideskinner

Glideskinnene gjør det enkelt og mer praktisk å sette inn og ta ut tilberedningen da stekeplatene glir mykt ut uten rykk og napp. Stekeplatene kan tas helt ut slik at du enkelt får tilgang til og oversikt over hele innholdet.

I tillegg er glideskinnene svært stabile slik at du kan håndtere tilberedningen uten å risikere å brenne deg. Glideskinnene gjør det mye enklere å ta tilberedningen ut av ovnen.

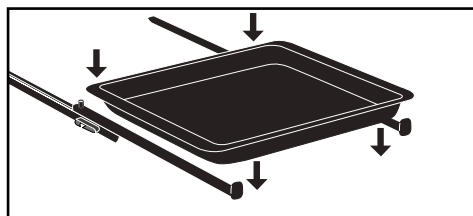

VIKTIG:

Tilbehøret kan deformeres ved høy varme, men det endrer ikke funksjonsevnen. Tilbehøret får tilbake sin opprinnelige form når det er avkjølt.



INSTALLERING OG DEMONTERING AV GLIDESKINNENE

Ta ut de 2 rillestengene og velg hvilket nivå (fra 2 til 5) du vil feste skinnene på. Skyv venstre skinne mot venstre rille og trykk tilstrekkelig hardt foran og bak på skinnen slik at de 2 klemmene på siden av skinnen skyves på plass i rillestangen. Gjør det samme med høyre skinne.

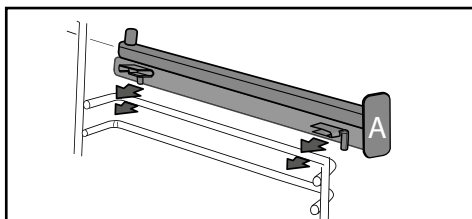

NB: den teleskopiske glidedelen av skinnen skal kunne trekkes utover med enden (A) mot deg.

Sett på plass de 2 rillestengene og sett deretter platen på de 2 skinnene. Systemet er klart til bruk.

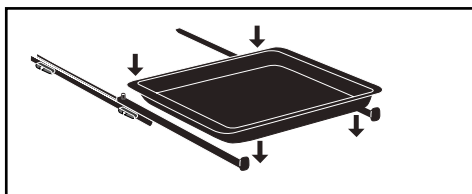

Ta på nytt ut rillestengene for å demontere skinnene.

Klemmene som er festet på hver skinne, må trykkes litt nedover for å frigjøre dem fra rillen. Dra skinnen mot deg.

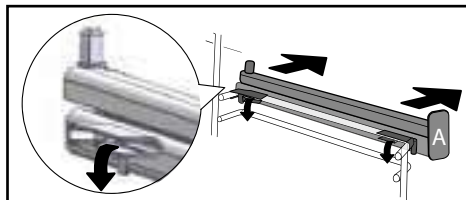

Råd

For å unngå mye matos fra steking av fett kjøtt anbefaler vi å ha litt vann eller olje i bunnen av langpannen.





Tilberedning

RÉGLAGES

• Innstilling av klokkeslettet

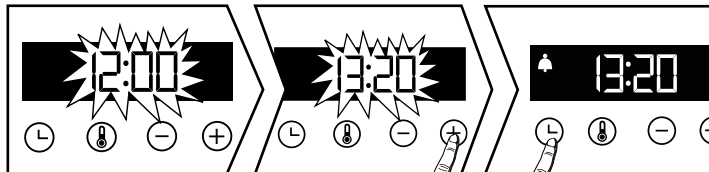
Når ovnen kobles til stikkkontakten, blinker klokkeslettet 12:00.



Innstill klokkeslettet med tastene + eller -. Bekreft med tasten . Etter strømbrudd blinker klokken.

• Endring av klokkeslettet

Funksjonsvelgeren skal stå på posisjon 0.

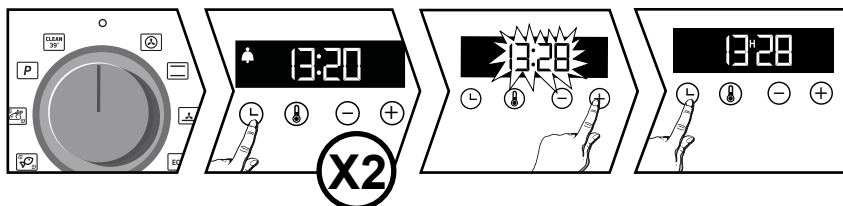

Trykk på tasten  og symbolet  vises på displayet. Trykk på nytt på . Still klokken med tastene + eller -.

Bekreft med tasten . Det innstilte klokkeslettet lagres automatisk etter noen sekunder.

• Minuttnedtelling

Denne funksjonen kan bare brukes når stekeovnen er slått av.

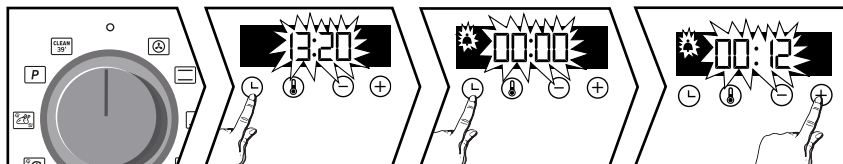

Funksjonsvelgeren skal stå på posisjon 0.

Trykk på tasten  Tidsuret  blinker. Still tidsuret med tastene + og -.

Trykk på knappen  for å bekrefte, og nedtellingen starter.

NB: Du kan når som helst endre eller avbryte en programmert tid på tidsuret. For å avbryte nedtellingen må du gå til menyen for minuttnedtelling og stille uret på 00:00. Hvis du ikke bekrefter, lagres det automatisk etter noen sekunder



• Tastelås

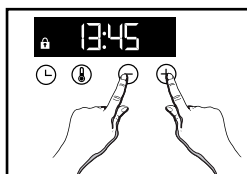



Trykk samtidig på tastene + og - inntil symbolet  vises på displayet. For å låse opp tastene må du trykke samtidig på tastene + og - inntil symbolet  forsvinner fra displayet.

MENY

Du kan stille inn flere ulike parametere på ovnen:

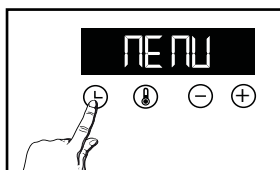
Trykk på tasten  inntil displayet viser «MENU» for å foreta innstillinger.



Trykk på nytt på tasten  for å velge de ulike innstillingene. Aktiver eller deaktiver de ulike innstillingene med tastene + og -. Se tabellen nedenfor:

	AUTO: I stekemodus slukkes lampen i ovnen etter 90 sekunder ON: I stekemodus lyser lampen hele tiden.
	Slå av/på tastelyd
	Slå av/på forvarmingsmodus
	Slå av/på demonstrasjonsmodus

Trykk på nytt på  for å gå ut av «MENU»..



Tilberedning

TILBEREDNINGSMÅTER:



VARMLUFT*

Temperaturen er minst 35°C og maks 250°C
Spesielt godt egnet til hvitt kjøtt, fisk og grønnsaker som skal være saftige. For steking av opptil 3 brett samtidig.



TRADISJONELL

Temperaturen er minst 35°C og maks 275°C
Spesielt godt egnet til langsom og delikat steking; mørt vilt. For bruning av steker av rødt kjøtt. Trekking i leirgryte eller annen form med lokk av retter som er forstekt på plate (coq au vin, gryteretter ...).



UNDERVARME M/VARMLUFT

Temperaturen er minst 75°C og maks 250°C
Spesielt godt egnet for fuktige retter (paier, frukterterter ...). Bunken blir godt stekt. Spesielt godt egnet til bakst som skal heve (formkake, gjærba-kst ...) og suffleer for at de ikke skal få en skorpe som hindrer dem i å ese.



ECO*

Temperaturen er minst 35°C og maks 275°C
Med denne innstillingen kan du spare energi og oppnå like gode stekeresultater som ellers.
Alle tilberedningene er uten forvarming.



KRAFTIG GRILL MEDIUM GRILL

Temperaturen er minst 180°C og maks 275°C
Spesielt godt egnet for å riste brød, gratinere en matrett eller karmellisere en crème brûlée...



GRILL M/VARMLUFT

Temperaturen er minst 100°C og maks 250°C
Fjærkre og steker holder seg saftige og får en fin stekeskorpe på alle sider.
Sett inn langpannen på nederste rille.
Spesielt godt egnet til alle typer fjærkre eller steker, for «forsegling» og gjennomsteking av lammelår, entrecôte. Fiskestykker holder seg saftige og gode.

Automatiske funksjoner:

Brandt tilbyr 3 nye funksjoner som automatisk kombinerer to stekefunksjoner: tradisjonell steking og dampsteking for å ivareta matvarenes ernæringsmessige kvaliteter og oppnå raskere steking.



HVITT KJØTT

Anbefalt for å bevare mørheten og saftigheten til svine- og kalvesteiker.



FISK

Anbefalt til steking av hel fisk eller fileter.



FJÆRKRE

Anbefalt til steking av kylling, kalkun, perlehøns og and.

For disse 3 funksjonene er det nok å tilføye lunkent vann i formen (stekebrettet) i anbefalt mengde, og plassere den (det) i ovnen på nederste rille. Matvaren som skal stekes settes inn på rille nummer 3. Med hensyn til hvor stor mengde vann som skal has i stekebrettet, se tabellen over kombinerte, automatiske

funksjoner med damp bakerst i anvisningen.



Ovnen er utstyrt med funksjonen «SMART ASSIST» som anbefaler en steketid når du programmerer en varighet. Denne tiden kan endres avhengig av hvilken tilberedningsmodus du har valgt.

**Tilberedningsmodus i henhold til reglene i standarden EN 60350-1: 2016 for å vise samsvar med kravene til energimerking i det europeiske direktivet 65/2014/EU.*



STARTE EN MATLAGING

• Umiddelbar stekestart

Programmereren skal bare vise tiden. Dette skal ikke blinke. Vri funksjonsvelgeren til ønsket posisjon.

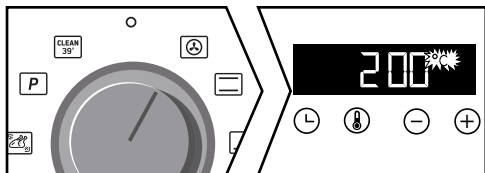



For manuelle funksjoner:

Ovnen begynner straks å varme opp. Ovnen anbefaler en temperatur som kan endres. Ovnen varmes opp og symbolet på temperatur blinker. Når ovnen når den programmerte temperaturen, piper den flere ganger.

For automatiske funksjoner:

 vises på displayet.

Velg matvaren din ved hjelp av tabellen bakerst i anvisningen. Trykk på tastene + og - helt til du oppnår ønsket innstilling i displayet, og bekreft deretter med tasten .

Vekten blinker; tast inn reell vekt på matvaren med tastene + og - , og bekreft deretter .



Du har ikke noe annet å stille inn; temperaturen og steketiden beregnes automatisk. Klokkeslettet for steketidens slutt blinker, bekreft med tasten . Stekingen starter umiddelbart.

• Endre temperaturen

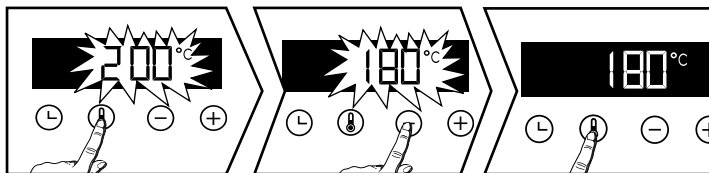
Trykk på . Temperaturen reguleres med + eller - . Trykk på  for å bekrefte.



• Programmering av steketid

Start en tilberedning med umiddelbar start, og trykk på . Steketiden blinker  Nå kan tiden innstilles. Trykk på + eller - for å innstille steketiden.

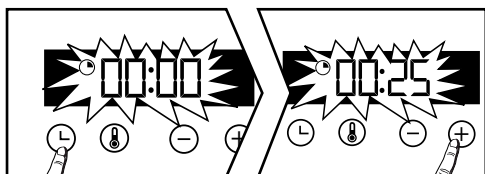





Ovnen er utstyrt med funksjonen «SMART ASSIST» som anbefaler en steketid når du programmerer en varighet. Denne tiden kan endres avhengig av hvilken tilberedningsmodus du har valgt. Se tabellen nedenfor:

Steketiden lagres automatisk etter noen sekunder. Nedtellingen av tiden starter straks steketemperaturen er nådd.

TILBEREDNINGSFUNKSJONER	ANBEFALT STEKETID
	30 min
	30 min
	30 min
ECO	30 min
	7 min
	15 min

• Steking med utsatt start

Still inn steketid på vanlig måte. Når du har stilt inn steketiden, trykk på tasten , i Klokkeslettet for stekeslutt blinker. .

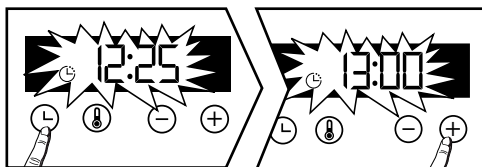

Displayet blinker, still inn klokkeslettet for stekeslutt med + eller -.

Klokkeslettet for stekeslutt lagres automatisk etter noen sekunder. Displayet av klokkeslettet for stekeslutt slutter å blinke.



INTERIØR - UTVENDIG RENGJØRING

• Rengjøring med pyrolyse





Advarsel

Fjern tilbehøret og trådhyllene fra ovnen før du begynner å rengjøre pyrolysen. Før du fortsetter med en pyrolyse-rengjøring av ovnen, må du fjerne store overløp som kan ha oppstått. Fjern overflødig fett fra døren med en fuktig svamp.

Av sikkerhetsmessige grunner utføres pyrolyse-rengjøringsoperasjonen først etter at døren har blitt blokkert automatisk, det er umulig å låse opp døren.

• Umiddelbar selvrenngjøring

Displayet skal vise klokkeslettet uten å blinke. Velg en av selvrenngjøringssyklusene med funksjonsvelgeren  eller  :

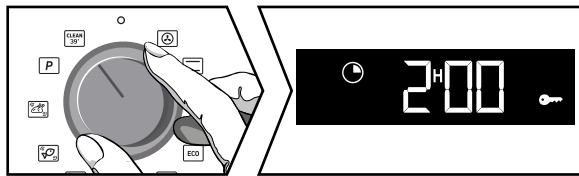



= Rengjøring på 39 minutter

- Ved hver stekeslutt vises "Clean 39" på displayet og foreslår å starte rengjøringen. Still funksjonsvelgeren på denne funksjonen og bekreft med tasten . Tiden 0:39 vises vekselvis med "Clean 39", og rengjøringen starter. Etter noen minutter kommer det til syne en nøkkel, ovnsdøren er nå automatisk låst av sikkerhetsmessige årsaker så lenge programmet varer.

Dersom du ønsker å starte en "Clean39" med kald eller ikke tilstrekkelig varm ovn, vil ikke betingelsene for start av programmet tillate denne typen rengjøring. 0:00 vises på skjermen og du må nå velge den andre posisjonen for selvrenngjøring  .

 = **Pyrolyse på 2 timer eller 1 time og 30 min., det er valgfritt.** Still funksjonsvelgeren på denne funksjonen.



Still funksjonsvelgeren på denne funksjonen.  vises på displayet. Trykk på + for å velge din type pyrolyse i forhold til hvor tilsmusset ovnen din er.

Avhengig av valget ditt vil varigheten, 2:00 (eller 1:30), vises. Bekreft med tasten .  (eller ) vises, og pyrolysen starter.

Ved slutten av rengjøringen viser displayet 0:00 og døren låses opp.

Sett funksjonsvelgeren tilbake på 0.

• Utsatt start av selvrenngjøring

Du har muligheten til å utsette starten av pyrolysen. Når varigheten av programmet vises på skjermen, trykk på tasten  og still inn det nye slutt-tidspunktet med tastene + og -, og bekreft deretter med . Selvrenngjøringen vil starte på et senere tidspunkt for å avsluttes på det nye, programmerte klokkeslettet. Still funksjonsvelgeren tilbake på 0 etter selvrenngjøringen.



Rengjøring

• Rengjøring av utvendig overflate

Bruk en myk klut dynket i rengjøringsmiddel for glass. Ikke bruk skruerekrem eller skuresvamp.

• Nettoyage des gradins-fils

Løft opp fremre del av rillestangen og skyv hele rillen for å frigjøre kroken foran. Dra hele rillen lett mot deg for å frigjøre krokene bak. Ta ut de to rillene på denne måten.

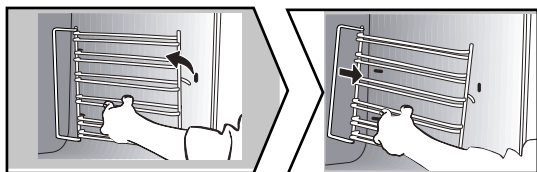

• Rengjøre de innvendige glassrutene

Advarsel

Bruk ikke skuremidler, skruesvamper eller metalliske skrapere for å rengjøre ovnens glassdør. Dette kan skrape opp overflaten og føre til at glasset sprekker.

Demonter døren for å rengjøre de innvendige glassrutene. Før rutene demonteres, tørk av overskytende fett på den innvendige glassruten med en myk klut og oppvaskåpe.

• Ta av og sette tilbake ovnsdøren

Åpne døren helt og blokker den ved hjelp av en av plastkilene i plastposen som følger med ovnen.

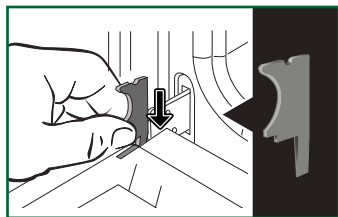

Ta av den første klipsede glassruten:

Bruk den andre kilen (eller en skrutrekker) og trykk på festene **A** for å frigjøre glassruten. Ta av glassruten.

Viktig:

Forsikre deg om at du markerer monteringsretningen for dette første vinduet (skinnende side mot deg)



Rengjøring

Avhengig av modell, består døren av to ekstra vinduer med en svart avstandsstykke i hvert hjørne. Fjern dem om nødvendig for rengjøring.

Ikke senk vinduene i vann. Skyll med rent vann og tørk av med en lufri klut.

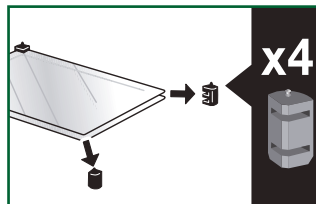
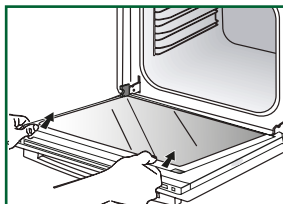
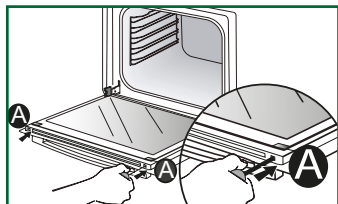

• Montere dørvindue

Etter rengjøring, plasser de fire pilene oppover, gummistoppene, og plasser glassenheten på nytt.

Fest den siste ruten i metallstoppene, og klem den, blanke siden mot deg. Fjern plastkilen.

Enheten din er i drift igjen.

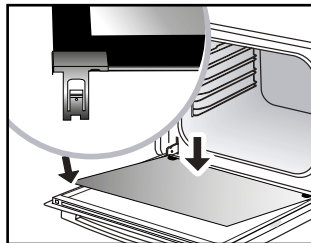
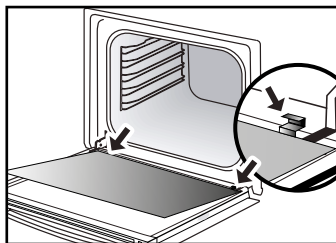
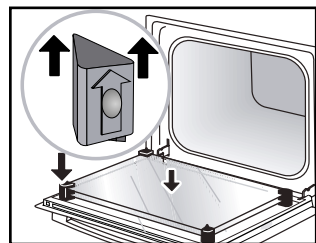

• Bytte lyspære



Advarsel:

Sørg for at ovnen er koblet fra strømmettet før du skifter lyspære for å unngå risiko for elektrisk støt. Foreta inngrepet når apparatet er avkjølt.

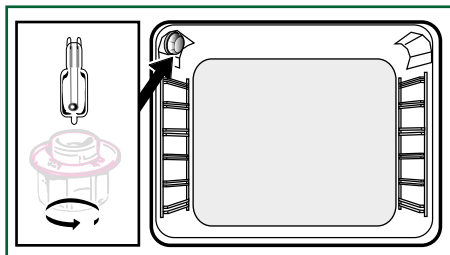

Spesifikasjoner for lyspæren:

25 W, 220-240 V~, 300°C, sokkel G9.

Når du skal skru av lampens beskyttelsesglass og lyspæren, bør du bruke gummihanser for å få bedre grep.



FEIL OG LØSNINGER

Ovnen blir ikke varm.

Sjekk at ovnen er tilkoblet strøm eller om sikringen i strømanlegget har gått. Øk valgt temperatur.

Lampen i ovnen fungerer ikke.

Skift lyspæren eller sikringen. Sjekk at ovnen er tilkoblet strøm.

Kjøleviften fortsetter å gå etter at du har skrudd av ovnen. Det er normalt.

Viften kan fortsette inntil høyst én time etter steking for å senke temperaturen inni og utenpå ovnen. Hvis den går mer enn 1 time, ta kontakt med kundeservice.

Pyrolysen starter ikke. Kontroller at døren er lukket.

Hvis det er feil med låsing av døren eller temperaturføleren, kontakt kundeservice.

- Symbolet blinker på displayet.

Feil med låsing av døren, kontakt kundeservice.

- Vibrasjonsstøy.

Kontroller at strømledningen ikke er i kontakt med bakveggen. Dette har ingen innvirkning på enhetens funksjon, men kan likevel generere vibrasjonsstøy under ventilasjon. Fjern enheten og flytt ledningen. Bytt ovnen.



REPARASJONER

Eventuelle reparasjoner på apparatet må utføres av en fagperson som er kvalifisert til å reparere merket. Når du kontakter kundeservice, går det raskere å behandle henvendelsen din hvis du oppgir alle apparatets referanser (salgsreferanse, servicereferanse, serienummer). Disse referansene står på merkeskiltet.

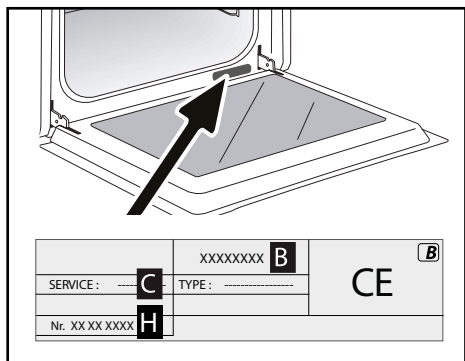

- B: Salgsreferanse
- C: Servicereferanse
- H: Serienummer
- I : QR Code

OPPRINNELIGE DELER

Hvis deler skal skiftes ut, må det kun brukes opprinnelige reservedeler.





RETTER	* * * * * * *												min	
Kjøtt														
Svinestek (1 kg)	200	2					180	2						60
Kalvestek (1 kg)	200	2					180	2						60-70
Oksestek	240	2												30-40
Lam (lår, skulder 2,5 kg)	220	1			220					200	2			60
Fjærkre (1 kg)	200	2			220		180	2		210	3			60
Kylling, stor	180	1												60-90
Kyllinglår					220	3				210	3			20-30
Svine-/kalvekoteletter					210	3								20-30
Oksekoteletter (1 kg)					210	3				210	3			20-30
Fårekoteletter					210	3								20-30
Fisk														
Grillet fisk					275	4								15-20
Bakt fisk	200	3					180	3						30-35
Foliedampet fisk	220	3					200	3						15-20
Grønnsaker														
Grateng (kokte grønnsaker)					275	2								30
Fløtegratinerte poteter	200	2					180	2						45
Lasagne	200	3					180	3						45
Fylte tomater	170	3					160	2						30
Bakverk														
Bløtkakebunn			180	2								180	2	35
Rullekake	220	3										180	2	5-10
Boller	180	1	210									180	2	35-45
Brownies	180	2					175	3						20-25
Kake - Sandkaker	180	1	180	1								180	2	45-50
Bærpai	200	2					180							30-35
Kremer	165	2										150	2	30-40

* Avhengig av modell



RETTER	*	*	*	*	*	*	*			min

Bakverk											
Muffins	220	3					200	3			5-10
Vannbakkels	200	3					180	3		180	30-40
Små former med butterdeig	220	3					200	3			5-10
Formkake med gjærdeig	180	3								175	30-35
Terte med mørdeig	200	1					195	1			30-40
Terte med butterdeig	215	1					200	1			20-25
Terte med gjærdeig	210	1					200	1			10-30

Diverse											
Grillspyd	220	3			210	4					10-15
Terrin	200	2					190	2			80-100
Pizza med mørdeig	200	2									30-40
Pizza med brøddeig											15-18
Middagspaier											35-40
Sufflé									180	2	50
Innbakte retter	200	2									40-45
Brød	220						200	220			30-40
Ristet brød	180				275	4-5					2-3
Gryterett med lokk	180	2							180	2	90-180

* Avhengig av modell



Alle temperaturer og steketider forutsetter at ovnen er forvarmet

NB: Alt kjøtt må stå i romtemperatur i minst 1 time før det settes i ovnen.

OMREGNING: TALL T °C									
°C	30	60	90	120	150	180	210	240	275
Tall	1	2	3	4	5	6	7	8	maks 9



Oppskrift med gjær (avhengig av modell)

Ingredienser:

- Mel 2 kg
- Vann 1240 ml
- Salt 40 g
- 4 pakker tørrgjær

Bland deigen i kjøkkenmaskinen og la den heve i ovnen.

Fremgangsmåte: For gjærdeig. Ha deigen i en ildfast form, ta ut rilleholderne og sett formen på ovnsbunnen.



















Varm ovnen med varmluftfunksjonen på 40-50 °C i 5 minutter. Slå av ovnen og la deigen heve 25-30 minutter i restvarmen.





SAMSVARSTESTER

IFØLGE STANDARD CEI 60350

MATVARE	* Stekemodus	RILLE	Tilbehør	°C	TID min.	FORVARMING
Sandkaker (8.4.1)		5	brett 45 mm	150	30-40	ja
Sandkaker (8.4.1)		5	brett 45 mm	150	25-35	ja
Sandkaker (8.4.1)		2 + 5	brett 45 mm + rist	150	25-45	ja
Sandkaker (8.4.1)		3	brett 45 mm	175	25-35	ja
Sandkaker (8.4.1)		2 + 5	brett 45 mm + rist	160	30-40	ja
Små formkaker (8.4.2)		5	brett 45 mm	170	25-35	ja
Små formkaker (8.4.2)		5	brett 45 mm	170	25-35	ja
Små formkaker (8.4.2)		2 + 5	brett 45 mm + rist	170	20-40	ja
Små formkaker (8.4.2)		3	brett 45 mm	170	25-35	ja
Små formkaker (8.4.2)		2 + 5	brett 45 mm + rist	170	25-35	ja
Myke kaker uten fett (8.5.1)		4	rist	150	30-40	ja
Myke kaker uten fett (8.5.1)		4	rist	150	30-40	ja
Myke kaker uten fett (8.5.1)		2 + 5	brett 45 mm + rist	150	30-40	ja
Myke kaker uten fett (8.5.1)		3	rist	150	30-40	ja
Myke kaker uten fett (8.5.1)		2 + 5	brett 45 mm + rist	150	30-40	ja
Elepai (8.5.2)		1	rist	170	90-120	ja
Elepai (8.5.2)		1	rist	170	90-120	ja
Elepai (8.5.2)		3	rist	180	90-120	ja
Gratinert overflate (9.2.2)		5	rist	275	3-6	ja

NB: Når tilberedningen bruker 2 riller, kan tiden variere.

* Avhengig av modell



TABELL OVER KOMBINERTE, AUTOMATISKE FUNKSJONER MED DAMP

Bryterens posisjon	Visning i displayet	Matvarer	Vannmengde som skal tilføres
		Kylling	500 ml lunkent vann i stekebrettet
		And	500 ml lunkent vann i stekebrettet
		Kalkun	500 ml lunkent vann i stekebrettet
		Perlehøns	800 ml lunkent vann i stekebrettet
		Hel fisk (stor)	500 ml lunkent vann i stekebrettet
		Hel fisk (flat)	300 ml lunkent vann i stekebrettet
		Liten, hel fisk	300 ml lunkent vann i stekebrettet
		Fiskefileter	300 ml lunkent vann i stekebrettet
		Svinestek	500 ml lunkent vann i stekebrettet
		Kalvestek	500 ml lunkent vann i stekebrettet

VIKTIG

Plasser stekebrettet (med lunkent vann) på nederste rille, nummer 1, og matvaren som skal tilberedes på rille nummer 3.



EN Informații pentru domeniul cavității (UE n° 6620/14)
DE Informationen zu Hohlraumkavitäten (UE n° 6620/14)
FR Informations concernant les foyers cavités (UE n° 6620/14)
ES Información sobre los hornos cavidades (UE n° 6620/14)
CS Informační údaje ke žhárkovým dutinám (UE n° 6620/14)
IT Informazioni relative ai forni a cavità (UE n° 6620/14)
DA Oplysninger for ovne til huleindretning (UE n° 6620/14)
NL Informatie met betrekking tot houtholende ovens (UE n° 6620/14)
FI tietoa uunien työstä (UE n° 6620/14)

EN	DE	FR	ES	CS	IT	DA	NL	FI	Symbol	Value	Unit	EN Symbol	FR Symbol	DE Symbol	ES Symbol	CS Symbol	IT Symbol	DA Symbol	NL Symbol	FI Symbol	
Type norme	KH725U	KH725V	KH725W	KH725X	KH725Y	KH725Z	KH725A	KH725B	KH725C	KH725D	KH725E	KH725F	KH725G	KH725H	KH725I	KH725J	KH725K	KH725L	KH725M	KH725N	
Modele / Identification																					
Type of oven	Simple = FR: Simple / CS: Jednoduchá / DE: Einzel / ES: Simple / IT: Semplice / NL: Simple / DA: Enkelt / NL: Eenvoudig / PT: Simples / SK: Jednoduchá / FI: Yksinkertainen / SV: Enkelt																				
Mass of the appliance	M	34,6	30,7	35,7	33,6	36,2	36,6	36,0	33,6	36,6	38,0	36,0	38,0	34,0	33,1						
Number of cavities		1	1	1	1	1	1	1	1	1	1	1	1	1	1	1	1	1	1	1	
Heat source per cavity (type of fuel or gas)	FR: Electricité / CS: Elektrická / DE: Strom / ES: Electricidad / IT: Energia elettrica / NL: Elektriciteit / DA: Elektricitet / NL: Elektriciteit / PT: Energia elétrica / SK: Elektrická / FI: Sähkö / SV: Elektricitet																				
Volume per cavity	V	73,0	73,0	73,0	73,0	73,0	73,0	73,0	73,0	73,0	73,0	73,0	73,0	73,0	73,0	73,0	73,0	73,0	73,0	73,0	
Energy consumption (mode per cavity) required to heat a standardised load in electric mode during a cycle in fan-forced	EC	0,82	0,82	0,89	0,79	0,79	0,79	0,79	0,79	0,79	0,79	0,79	0,79	0,79	0,79	0,79	0,79	0,79	0,79	0,79	
Energy consumption (mode per cavity) required to heat a standardised load in electric mode during a cycle in conventional	EC	0,82	0,82	0,89	0,79	0,79	0,79	0,79	0,79	0,79	0,79	0,79	0,79	0,79	0,79	0,79	0,79	0,79	0,79	0,79	
Energy Efficiency Index per cavity	EI	90,3	86,3	80,2	81,4	81,4	81,4	81,4	81,4	81,4	81,4	81,4	81,4	81,4	81,4	81,4	81,4	81,4	81,4	81,4	

FR

CS

DA

DE

EL

EN

ES

FI

IT

NL

NO

PL

PT

SK

SV

Brandt



INSTRUKCJA OBSŁUGI PL

PIEKARNIK

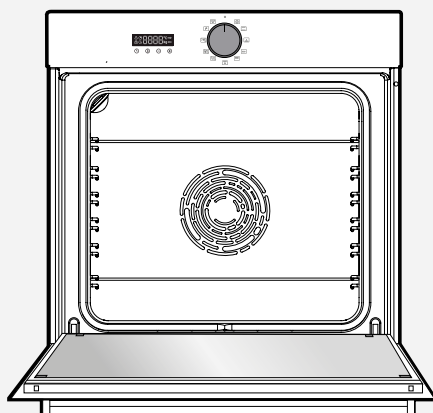

ORIGINE
FRANCE[®]
GARANTIE

BYCert.6011825

Szanowni Klienci,

Serdecznie dziękujemy za zaufanie okazane naszej firmie poprzez dokonanie zakupu produktu marki **BRANDT**.

Produkt ten został zaprojektowany i wytworzony myśląc o was, waszym stylu życia i potrzebach - nasza firma zawsze stara się spełnić wszystkie oczekiwania swoich klientów. Opracowaliśmy go, wykorzystując całość naszej wiedzy, ducha innowacyjności oraz pasję, która stanowi kluczowy czynnik naszej działalności od ponad 60 lat.

Starając się wciąż w lepszy sposób spełniać oczekiwania naszych klientów, dział obsługi klienta naszej firmy bierze pod uwagę wszystkie Państwa uwagi i udziela odpowiedzi na jakiegokolwiek pytania lub sugestie.

Prosimy o kontaktowanie się z naszą firmą za pośrednictwem witryny **www.brandt.com**, na której publikowane są informacje dotyczące naszych najnowszych innowacji, a także wszelkie użyteczne informacje dodatkowe.

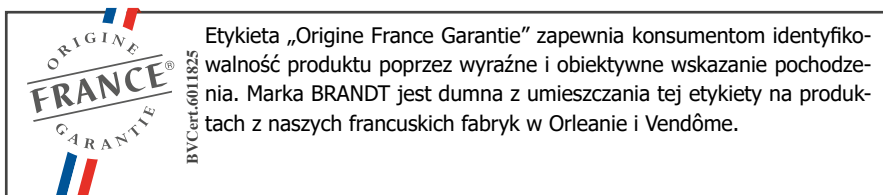

<https://brandt.fr/>

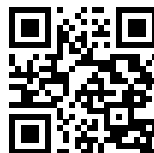

Uwaga:

Przed uruchomieniem urządzenia należy dokładnie przeczytać niniejszą instrukcję instalacji i obsługi, aby szybciej zapoznać się z zasadami jego działania.



BEZPEČNOSTNÍ POKYNY	4
ŽIVOTNÍ PROSTŘEDÍ A ÚSPORA ENERGIE	6
Prostředí	6
Tip na úsporu energie	6
instalace spotřebiče	7
Volba umístění a instalace	7
Elektrické připojení	8
Popis vašeho spotřebiče	9
Prezentace trouby	9
Displej a ovládací tlačítka	9
Příslušenství	10
Používání zařízení	12
Nastavení	12
Nabídka nastavení	13
Režimy vaření	14
Zahájení vaření	15
Péče o zařízení	17
Čištění interiéru - exteriéru	18
Anomálie a řešení	19
Poprodejní servis	21
Intervence	21
PODPORA VAŘENÍ	21
Tabulky vaření	22
Recepty s droždím	24
Funkční zkoušky způsobilosti	25
Funkce s automatickou kombinovanou párou	26



WSKAZÓWKI BEZPIECZEŃSTWA

SAŁ TO WAŻNE WSKAZÓWKI BEZPIECZEŃSTWA, KTÓRE NALEŻY DOKŁADNIE PRZECZYTAĆ I ZACHOWAĆ DO WYKORZYSTANIA W PRZYSZŁOŚCI.

Niniejsza instrukcja jest również dostępna do pobrania na stronie internetowej marki.

Uwaga:

Po odbiorze dostarczonego urządzenia należy natychmiast je rozpakować. Sprawdzić ogólny wygląd urządzenia. Wpisać wszelkie ewentualne zastrzeżenia na potwierdzeniu dostawy i zachować jego jeden egzemplarz. Przed uruchomieniem urządzenia należy dokładnie przeczytać niniejszą instrukcję instalacji, aby szybciej zapoznać się z zasadami jego działania. Należy zachować niniejszą instrukcję obsługi wraz z urządzeniem. W razie sprzedaży lub przekazania urządzenia jakiegokolwiek innej osobie należy przekazać jej również niniejszą instrukcję obsługi. Prosimy o zapoznanie się z tymi wskazówkami przed przystąpieniem do instalacji i użytkowania urządzenia. Zostały one opracowane dla zapewnienia bezpieczeństwa wszystkich użytkowników urządzenia.

— Urządzenie jest przeznaczone do wykorzystania przez osoby prywatne w miejscu zamieszkania. Żadne części tego urządzenia nie zawierają azbestu.

— Urządzenie jest przeznaczone do zwykłego użytku domowego. Nie wolno wykorzystywać go do jakichkolwiek celów handlowych lub przemysłowych, bądź w żadnych innych celach, do jakich nie jest przeznaczone.

— Nie wolno w żaden sposób modyfikować lub próbować modyfikować parametrów tego urządzenia. Stanowiłoby to zagrożenie dla użytkownika.

— Nie wolno układać folii aluminiowej bezpośrednio na płycie urządzenia, ponieważ nagromadzenie ciepła może spowodować uszkodzenie emaliowanej powłoki.

— Nie należy układać żadnych ciężkich przedmiotów na otwartych drzwiczkach piekarnika i uważać, aby dzieci nie wspinały się i nie siadały na nich.

— Piekarnik nie jest przeznaczony do przechowywania żywności lub jakichkolwiek przedmiotów.

— Po zakończeniu użytkowania urządzenia należy upewnić się, że wszystkie elementy sterowania zostały ustawione w pozycji wyłączonej.

— Podczas wykonywania jakichkolwiek prac dotyczących czyszczenia wnętrza piekarnika, urządzenie musi być wyłączone.

— Przed przystąpieniem do demontażu szyby należy poczekać na schłodzenie się urządzenia.

Urządzenie może być używane przez dzieci w wieku powyżej 8 lat i osoby o ograniczonych możliwościach fizycznych, czuciowych lub umysłowych lub bez



odpowiedniego doświadczenia lub wiedzy, jeżeli wcześniej otrzymały one instrukcje dotyczące obsługi urządzenia lub zostały w odpowiedni sposób przeszkolone i zrozumiały zagrożenia, którym mogą podlegać. Dzieci nie mogą wykorzystywać urządzenia do zabawy. Wszelkie czynności dotyczące czyszczenia i konserwacji urządzenia nie mogą być przeprowadzane przez dzieci pozostawione bez nadzoru.

— Należy pilnować, aby dzieci nie bawiły się urządzeniem.

OSTRZEŻENIE: Urządzenie i jego dostępne elementy stają się gorące w trakcie użytkowania. Należy uważać, aby nie dotknąć elementów grzewczych, które znajdują się wewnątrz piekarnika. Dzieci w wieku poniżej 8 lat należy trzymać z dala od urządzenia, chyba że znajdują się pod stałym nadzorem.

— Urządzenie jest przeznaczone do pracy z zamkniętymi drzwiczkami.

— Przed rozpoczęciem czyszczenia pirolizowego piekarnika należy wyjąć wszystkie akcesoria i wytrzeć największe ślady ochłapania.

— Podczas działania funkcji czyszczenia powierzchnie urządzenia mogą nagrzewać się do wyższej temperatury, niż podczas normalnego użytkowania. Zalecane jest, aby dzieci pozostawały w bezpiecznej odległości.

— Nie należy używać jakichkolwiek urządzeń do czyszczenia parą.

— Przed wyjęciem dolnej płyty urządzenia należy odłączyć je od zasilania. Po zakończeniu czyszczenia element

zabezpieczający musi zostać ponownie włożony do urządzenia w sposób zgodny z zaleceniami.

— Do czyszczenia szklanych drzwiczek piekarnika nie należy używać ściernych środków czyszczących lub gąbek metalowych, ponieważ może to spowodować zarysowanie powierzchni i pęknięcie szyby.

OSTRZEŻENIE : Aby uniknąć ryzyka porażenia prądem elektrycznym, przed przystąpieniem do wymiany lampki należy upewnić się, że urządzenie jest odłączone od zasilania. Należy wykonywać jakiegokolwiek prace dopiero, kiedy urządzenie jest schłodzone. Aby odkręcić szybę i lampkę, należy używać gumowych rękawic - ułatwi to przeprowadzenie demontażu.

Po zakończeniu instalacji gniazdko zasilania musi być dostępne. Konieczne jest zapewnienie możliwości odłączenia urządzenia od sieci zasilania za pomocą wyjęcia wtyczki z gniazdka lub poprzez zamontowanie osobnego wyłącznika w sposób zgodny z zasadami dotyczącymi instalacji.

Dla zapewnienia bezpieczeństwa, w razie uszkodzenia przewodu zasilającego, może on zostać wymieniony na nowy jedynie przez producenta, jego serwis naprawczy lub osobę posiadającą identyczne kwalifikacje.

— Urządzenie może zostać zainstalowane



Instalacja

pod blatem lub w postaci kolumny w sposób pokazany na schemacie instalacji.

- Wyśrodkować urządzenie wewnątrz mebla, aby zapewnić odstęp wynoszący co najmniej 10 mm od mebli sąsiednich. Materiał mebla, w którym urządzenie jest instalowane musi zapewniać odpowiednią odporność na działanie wysokiej temperatury (lub mebel musi zostać zabezpieczony tego rodzaju materiałem). Aby zapewnić większą stabilność, należy zamocować piekarnik wewnątrz mebla przy użyciu 2 śrub, przeprowadzając je przez otwory przeznaczone do tego celu

w słupkach bocznych.

- Aby uniknąć możliwości przegrzania, urządzenie nie może być instalowane za dekoracyjnymi drzwiczkami.



Oszczędność środowiska i energii

ŚRODOWISKO

Materiały opakowaniowe tego urządzenia nadają się do recyklingu. Weź udział w ich recyklingu, a tym samym pomóż chronić środowisko, umieszczając je w przeznaczonych do tego celu pojemnikach komunalnych.

Twoje urządzenie zawiera również wiele materiałów nadających się do recyklingu. Dlatego jest oznaczony tym logo, aby wskazać, że zużytych urządzeń nie należy mieszać z innymi odpadami.

Recykling urządzeń organizowany przez Twojego producenta będzie zatem prowadzony na najlepszych warunkach, zgodnie z obowiązującą europejską dyrektywą dotyczącą zużytego sprzętu elektrycznego i elektronicznego.

Skontaktuj się z ratuszem lub sprzedawcą, aby uzyskać informacje o punktach zbiórki używanych urządzeń znajdujących się najbliżej Twojego domu.

Dziękujemy za współpracę w ochronie środowiska.

Wskazówka dotycząca oszczędzania energii

Podczas gotowania drzwiczki piekarnika powinny być zamknięte.



Instalacja

WYBÓR MIEJSCA INSTALACJI I WBUDOWANIA

Na schematach pokazane zostały wymiary mebla, w którym piekarnik może być wbudowany.

Urządzenie może zostać zainstalowane pod blatem lub **(A)** w postaci kolumny **(B)**. Jeżeli mebel jest otwarty, jego otwarcie z tyłu musi wynosić maksymalnie 70 mm (C et D). Zamocować piekarnik wewnątrz mebla. W tym celu należy wyjąć ograniczniki gumowe i wywiercić otwory o \varnothing 2 mm w ścianie mebla, aby uniknąć rozszczepienia drewna. Zamocować piekarnik za pomocą 2 śrub. Ponownie założyć ograniczniki gumowe.



Rada :

Aby mieć pewność, że instalacja jest zgodna z wymaganiami, nie wahaj się wezwać specjalisty od urządzeń.



Ostrzeżenie :

Jeśli instalacja elektryczna w Twoim domu wymaga modyfikacji w celu podłączenia urządzenia, wezwij wykwalifikowanego elektryka. Jeśli piekarnik wykazuje jakąkolwiek anomalie, należy odłączyć go lub wyjąć bezpiecznik odpowiadający linii przyłączeniowej piekarnika.

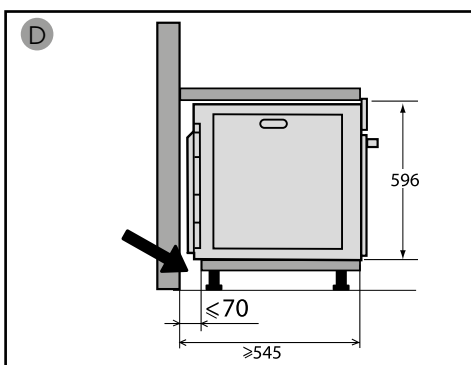
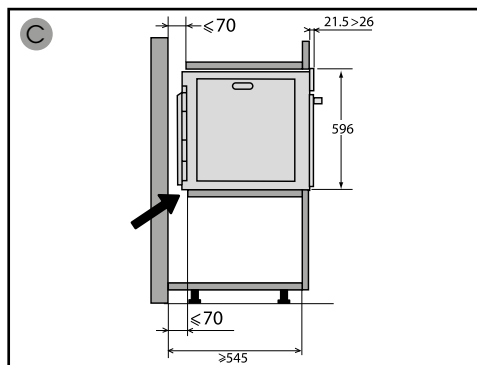
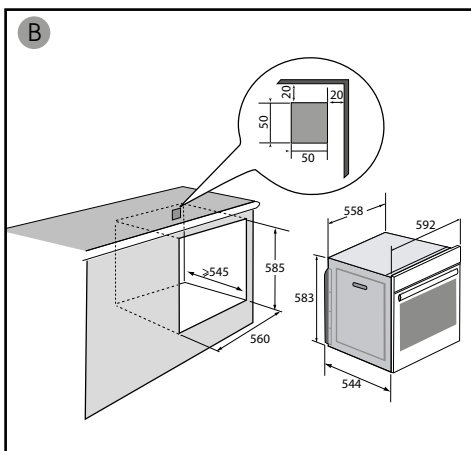
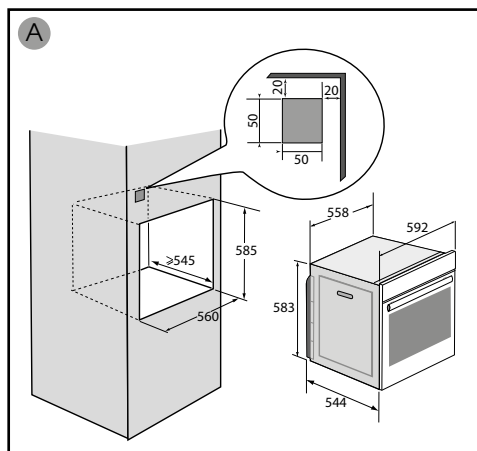



POŁĄCZENIE ELEKTRYCZNE

Piekarnik należy podłączyć za pomocą standardowego kabla zasilającego z 3 przewodami o przekroju $1,5 \text{ mm}^2$ (1 faza + 1 N + uziemienie), który należy podłączyć do sieci 220 ~ 240 V poprzez gniazdo. Norma IEC 60083 lub wielobiegowe urządzenie odłączające zgodnie z zasady instalacji.

Ostrzeżenie

Przewód ochronny (zielono-żółty) jest połączony do zacisku urządzenia i musi być połączony z uziemieniem instalacji. Bezpiecznik instalacyjny musi mieć 16 amperów.

Nie możemy ponosić odpowiedzialności w przypadku wypadku lub zdarzenia wynikającego z nieistniejącego, wadliwego lub nieprawidłowego uziemienia lub w przypadku niewłaściwego podłączenia.

• **Przed pierwszym użyciem**

Przed pierwszym użyciem piekarnika należy go rozgrzać pusty, przy zamkniętych drzwiczkach, przez około 15 minut na najwyższej temperaturze. w celu włamania się do urządzenia. Wełna mineralna, która otacza komorę pieca, może początkowo wydzielać szczególny zapach ze względu na swój skład. Podobnie możesz zauważyć dym. To wszystko jest normalne.

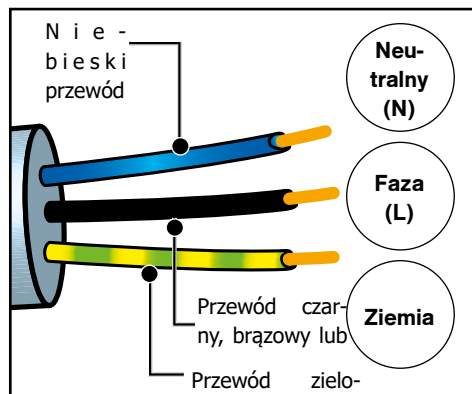



Poznaj swoje urządzenie

PREZENTACJA PIEKARNIKA

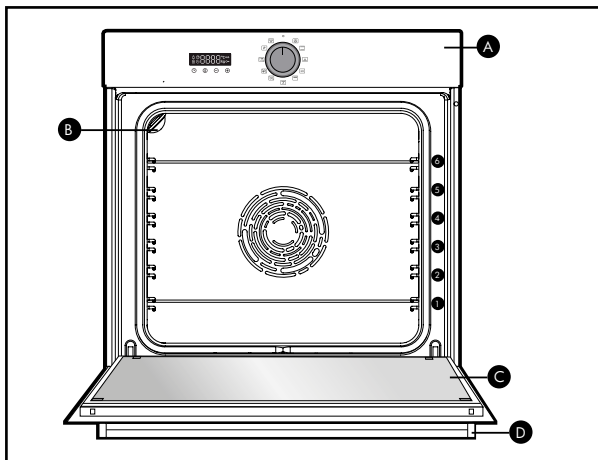

- A** Panel sterowania
- B** Lampa
- C** Drzwi
- D** Uchwyt

Ten piekarnik ma 6 poziomów na akcesoria: półki od 1 do 6.

• WYŚWIETLACZ



- Czas pieczenia
- Zakończenie pieczenia
- Blokada klawiatury
- Minutnik
- Wskaźnik temperatury
- wstępnego
- Blokada drzwiczek

• PRZYCISKI

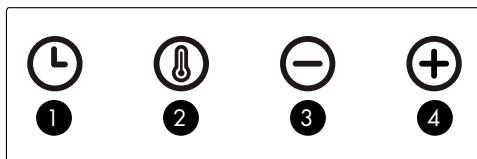

- 1** Ustawienie godziny i daty
- 2** Ustawienie temperatury
- 3** Zmniejszanie wartości
- 4** Zwiększanie wartości



AKCESORIA

• Kratka zabezpieczona przed przewróceniem się

Kratka może być używana dla wszystkich rodzajów naczyń i form zawierających produkty przeznaczone do pieczenia lub zapiekania. Może ona zostać również wykorzystana do grillowania (układając produkty bezpośrednio na kratce).

Włożyć element zabezpieczający przed przewróceniem się w taki sposób, aby był skierowany w głąb piekarnika.

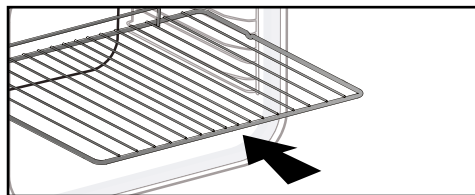

• Naczynie uniwersalne, brytfanna

45 mm

Mocowana w wycięciach pod kratką, uchwytem skierowanym w stronę drzwiczek piekarnika. Służy do zbierania soków i tłuszczu ociekającego podczas pieczenia, może również zostać wypełniona wodą do połowy i użyta do gotowania w kąpeli wodnej.



• Forma do ciast, 20 mm

Insérer dans les gradins poignée vers la porte du four. Idéal pour la cuisson de cookies, sablés, cupcake. Son pan incliné vous permet de déposer facilement vos préparations dans un plat. Peut aussi être inséré dans les gradins sous la grille, pour recueillir les jus et les graisses des grillades.

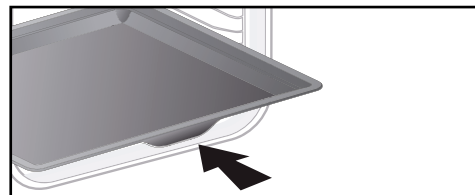

• System szyn uchylnych

Dzięki zastosowaniu nowego systemu szyn uchylnych, pieczenie staje się bardziej praktyczne i łatwe, ponieważ płyty mogą być wyjmowane w sposób całkowicie wygodny, co zdecydowanie ułatwia posługiwanie się nimi. Naczynia mogą zostać całkowicie wyjęte, co umożliwia ich całkowitą dostępność. Ponadto, ich stabilność umożliwia pieczenie produktów w sposób całkowicie bezpieczny, ograniczając ryzyko poparzenia. Wyjmowanie produktów z piekarnika jest zdecydowanie łatwiejsze.

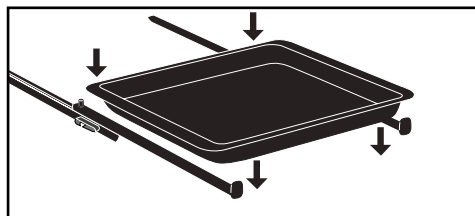

! Przed rozpoczęciem czyszczenia pirolizowego piekarnika należy wyjąć akcesoria i stopnie.

! Porada

Aby uniknąć wydzielania się dymu podczas pieczenia tłustego mięsa, zalecamy umieszczenie na spodzie brytfanny niewielkiej ilości wody lub oleju.



Poznaj swoje urządzenie

MONTAŻ I DEMONTAŻ TORU PRZESUWNEGO

Po usunięciu 2 drutów schodkowych wybierz wysokość stopnia (od 2 do 5), do których chcesz przymocować swoje szyny. Docisnąć lewą szynę do lewego stopnia, dociskając odpowiednio przód i tył szyny, tak aby 2 zaczepy z boku szyny pasowały do drucianej półki. Postępuj w ten sam sposób dla prawej szyny.

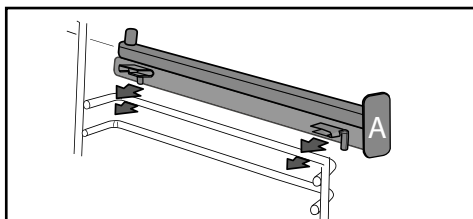

UWAGA: teleskopowa wysuwana część szyny musi rozłożyć się w kierunku przodu piekarnika, ogranicznik A skierowany w Twoją stronę.

Umieść 2 druty krokowe na miejscu, a następnie umieść płytę na 2 szynach, system jest gotowy do użycia.

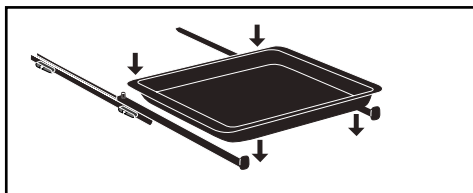

Aby zdemontować szyny, ponownie usuń stopnie z drutu.

Lekko rozłóż zaczepy przymocowane do każdej szyny w dół, aby zwolnić je ze stopnia. Pociągnij poręcz do siebie.

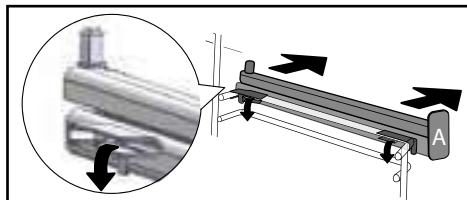

Rada :

Aby uniknąć wydzielania oparów podczas gotowania tłustych mięs, zalecamy dodanie niewielkiej ilości wody lub oleju na dno naczynia.





Korzystanie z urządzenia

USTAWIENIA

• Ustawienie czasu

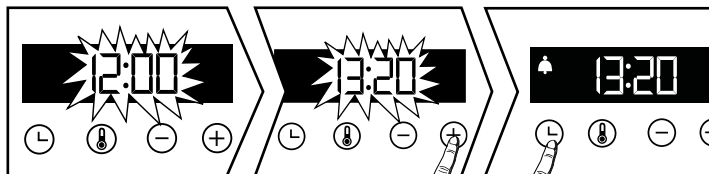
Po włączeniu zasilania wyświetlacz miga o godzinie 12:00.





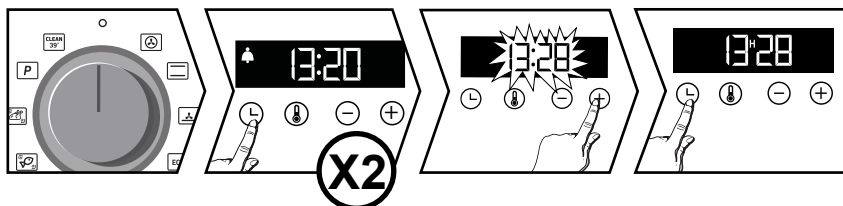

Ustaw czas za pomocą klawiszy + lub -. Potwierdź kluczem . W przypadku awarii zasilania czas miga.

• Modification de l'heure

Przełącznik funkcji musi znajdować się w pozycji 0.





Naciśnij klawisz  symbol  pojawi się ponownie naciśnij . Dostosuj ustawienie czasu za pomocą przycisków + lub -. Potwierdź kluczem . Rejestracja nastawionego czasu następuje automatycznie po kilku sekundach.

• Regulator czasowy

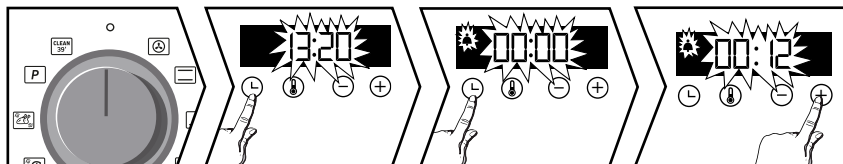
Tej funkcji można używać tylko wtedy, gdy piekarnik jest wyłączony.



Przełącznik funkcji musi znajdować się w pozycji 0.



Naciśnij klawisz  symbol  Pojawia się .. Dostosuj ustawienie czasu za pomocą przycisków + lub -. Potwierdź kluczem .

NB: W każdej chwili masz możliwość zmiany lub anulowania programowania timera. Aby anulować, wróć do menu timera i ustaw na 00:00. Bez walidacji nagrywanie odbywa się automatycznie po kilku sekundach.

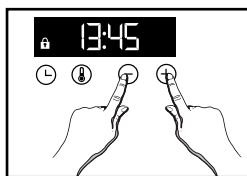

• Blokada klawiatury (bezpieczeństwo dzieci)



Jednocześnie naciśnięć klawisze + i - aż do wyświetlenia symbolu  na ekranie. Aby ją odblokować, naciśnij jednocześnie klawisze + i - aż do symbolu  zniknie z ekranu.



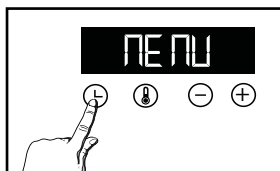

MENU USTAWIEŃ

Możesz interweniować na różnych parametrach piekarnika, w tym celu: Naciskaj przycisk, aż wyświetli się „MENU”, aby uzyskać dostęp do trybu ustawień.



Wciśnij ponownie przycisk  przewijając różne ustawienia.

Aktywuj lub dezaktywuj różne parametry za pomocą przycisków + i -, patrz tabela poniżej:

	AUTO: W trybie gotowania lampa wewnętrzna gaśnie po 90 sekundach ON: W trybie gotowania lampa jest zawsze włączona.
	Włączanie / wyłączenie dźwięków klawiszy
	Włączanie / wyłączenie trybu podgrzewania
	Włączanie / wyłączenie trybu demo

Aby wyjść z „MENU”, naciśnij ponownie .



Korzystanie z urządzenia

TRYBY GOTOWANIA

FUNKCJE RĘCZNE:



KONWEKCAJA*

Temperatura min 35 ° C max 250 ° C

Zalecany do utrzymywania wilgoci w białych mięsach, rybach, warzywach. Do gotowania wielokrotnego do 3 poziomów.



TRADYCYJNY

Temperatura min 35 ° C max 275 ° C

Zalecane do powolnego i delikatnego gotowania: miękka dziczyzna. Do obsmażania pieczeni z czerwonego mięsa. Do gotowania na wolnym ogniu w zamkniętym naczyniu żaroodpornym wcześniej rozpuszczonych potraw na płycie grzejnej (coq au vin, gulasz).



PULSUJĄCA GLEBA

(min. temperatura 75 ° C max 250 ° C)

Polecane do dań mokrych (quiche, soczyste ciasta owocowe ...). Ciasto będzie dobrze ugotowane pod spodem. Polecany do przetworów na zakwasie (ciasto, bułeczki, kouglof ...) oraz do sufletów w, które nie zostaną zablokowane przez skórę.



ECO*

Temperatura min 35 ° C max 275 ° C

Ta pozycja oszczędza energię przy zachowaniu właściwości gotowania.

Całe gotowanie odbywa się bez podgrzewania.



MOCNY GRILL

Temperatura min 180 ° C max 275 ° C

Zalecane do grillowania tostów, zapiekania potraw, przyrumieniania crème brûlée ...



GRILL IMPULSOWY

Temperatura min 100 ° C max 250 ° C

Soczysty i chrupiący drób i pieczenie z każdej strony.

Wsuń miskę ociekową na dolną półkę.

Zalecany do każdego drobiu i pieczeni, do obsmażania i gotowania pieczeni jagnięcej, żeber wołowych. Aby zachować ich kremówkę z układarkami do ryb.

Funkcje automatyczne:

Brandt oferuje 3 nowe funkcje, które automatycznie łączą dwa tryby gotowania: gotowanie tradycyjne i gotowanie na parze w celu zachowania wartości odżywczych żywności i uzyskania szybszego gotowania.



MIĘSO BIAŁE

Zalecane dla zachowania miękkości i smaku pieczeni wieprzowych i cielęcych.



RYBY

Zalecany do gotowania całej ryby lub filetów.



DRÓB

Polecane do gotowania kurczaków, indyków, perliczek i kaczek.

Aby skorzystać z tych 3 funkcji, wystarczy dodać do naczynia (ociekacza) wystarczającą ilość letniej wody i włożyć do piekarnika na dolnej półce, a potrawę ugotować na poziomie 3.

Informacje na temat ilości wody, jaką należy umieścić w misce ociekowej, znajdują się w tabeli z automatycznymi połączonymi funkcjami z kombinacją pary na końcu instrukcji.



System „Smart Assist”

Twój piekarnik jest wyposażony w funkcję „Smart Assist”, która podczas programowania czasu trwania zaleci modyfikowalny czas gotowania w zależności od wybranego trybu pieczenia.

** Metoda gotowania przeprowadzona zgodnie z wymaganiami normy EN 60350-1: 2016 w celu wykazania zgodności z wymaganiami dotyczącymi etykiet efektywności energetycznej określonymi w rozporządzeniu UE / 65/2014.*



Korzystanie z urządzenia

ROZPOCZĘCIE GOTOWANIA

• Rozpoczęcie natychmiastowego gotowania

Programista powinien wyświetlać tylko godzinę. To nie powinno migać.

Obróć przełącznik funkcji do wybranej pozycji.

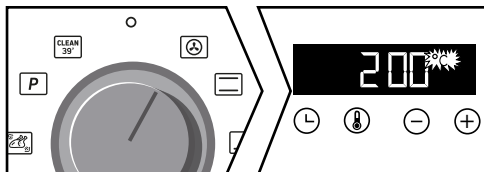



W przypadku funkcji ręcznych:

Wzrost temperatury rozpoczyna się natychmiast. Twój piekarnik zaleca temperaturę, którą można zmienić. Piekarnik nagrzewa się i miga wskaźnik temperatury. Po osiągnięciu przez piekarnik ustawionej temperatury rozlegnie się seria sygnałów dźwiękowych.

W przypadku funkcji automatycznych:

 pojawia się na ekranie.

Wybierz jedzenie, korzystając z tabeli na końcu ulotki. Naciskaj klawisze + i - aż do uzyskania pożądanego schematu na wyświetlaczu, a następnie zatwierdź klawiszem .

Miga ciężar; wprowadź rzeczywistą wagę żywności za pomocą klawiszy + i -, a następnie zatwierdź .

Nie musisz nic ustawiać, temperatura i czas gotowania są obliczane automatycznie. Miga koniec czasu pieczenia, potwierdzić klawiszem . Twoje gotowanie zaczyna się natychmiast.



• Zmiana temperatury

włączyć .

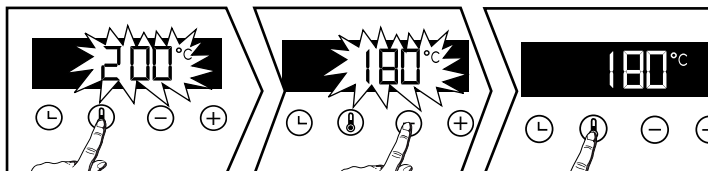
Ustaw temperaturę za pomocą + lub - Potwierdź naciskając .



• Modyfikacja czasu trwania

Natychmiast gotuj, a następnie naciśnij , czas gotowania  miga, ustawienie jest możliwe. Naciśnij + lub -, aby ustawić czas gotowania.

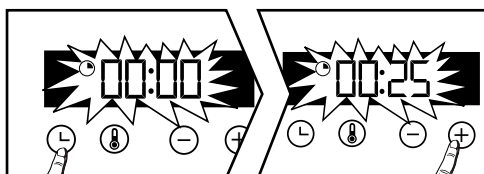





System „Smart Assist”

Twój piekarnik jest wyposażony w funkcję „Smart Assist”, która podczas programowania czasu trwania zaleci modyfikowalny czas gotowania w zależności od wybranego trybu pieczenia (patrz tabela).

Czas gotowania jest automatycznie zapisywany po kilku sekundach. Czas jest odliczany natychmiast po osiągnięciu temperatury gotowania.

FUNKCJA PIECZENIA	TRWANIE
	30 min
	30 min
	30 min
ECO	30 min
	7 min
	15 min

• Zmiana końca czasu gotowania

Postępuj zgodnie z zaprogramowanym czasem trwania. Po ustawieniu czasu gotowania naciśnij przycisk , koniec czasu gotowania  miga.

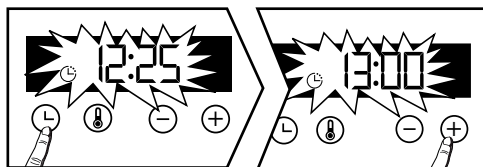

Wyświetlacz miga, ustawić koniec czasu gotowania za pomocą + lub -. Zakończenie pieczenia jest automatycznie rejestrowane po kilku sekundach. Koniec gotowania nie miga.



CZYSZCZENIE WEWNĘTRZNE - ZEWNĘTRZNE

• Czyszczenie wnęki przez pirolizę

Ostrzeżenie

Przed przystąpieniem do czyszczenia pirolitycznego wyjąć akcesoria i ruszty z piekarnika. Przed przystąpieniem do czyszczenia piekarnika metodą pirolizy usuń wszelkie większe przelewy, które mogły wystąpić. Usuń nadmiar smaru z drzwi wilgotną gąbką.

Ze względów bezpieczeństwa operacja czyszczenia pirolizy jest przeprowadzana dopiero po automatycznym zablokowaniu drzwi, nie ma możliwości ich odblokowania.

• Natychmiastowe automatyczne czyszczenie

Programator powinien wyświetlać godzinę bez migania. Wybierz jeden z cykli samooczyszczania za pomocą pokrętła funkcji o :

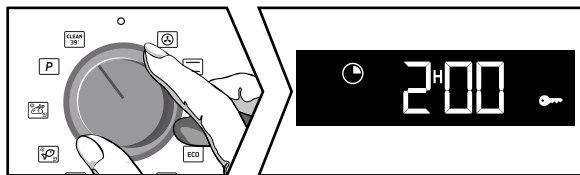

= **Czyszczenie w 39 minut**

- Po każdym zakończeniu gotowania na ekranie przewija się napis „Clean 39”, oferując rozpoczęcie tego czyszczenia. Ustaw dźwignię na tej funkcji i potwierdź klawiszem . Czas trwania 0:39 jest wyświetlany na przemian z „Wyczyść 39”, rozpocznie się czyszczenie. Po kilku minutach pojawi się przycisk, drzwi piekarnika zostaną automatycznie zablokowane dla bezpieczeństwa podczas całego programu.

Jeśli chcesz uruchomić piekarnik „Clean 39”, który jest zimny lub niewystarczająco gorący, warunki uruchomienia programu uniemożliwiają to czyszczenie. 0:00 pojawi się na ekranie, będziesz musiał wybrać inną pozycję samoczyszczenia .

= **Piroliza trwająca 2 godziny lub 1 godzinę 30 minut, zależnie od potrzeb. Ustaw dźwignię na tej funkcji.**

Ustaw dźwignię na tej funkcji. s, Wyświetlane na ekranie. Naciśnij +, aby wybrać pirolizę w zależności od stopnia zabrudzenia piekarnika.

W zależności od wyboru wyświetlany jest czas trwania 2:00 (lub 1:30). Potwierdź kluczem . (ou s) jest wyświetlany, rozpocznie się piroliza. Po zakończeniu czyszczenia na wyświetlaczu pojawi się 0:00 i drzwi zostaną odblokowane.

Ustaw selektor funkcji na 0.

• Odroczone samooczyszczanie

Masz możliwość odroczenia rozpoczęcia pirolizy. Gdy na ekranie pojawi się czas trwania programu, należy nacisnąć przycisk et ustawić nowy czas zakończenia za pomocą klawiszy + i -, a następnie zatwierdzić za pomocą . Samoczyszczenie rozpocznie się później i zakończy w nowym zaplanowanym czasie. Po zakończeniu czyszczenia ustawić przełącznik funkcji na 0.



• Czyszczenie powierzchni zewnętrznej

Użyj miękkiej szmatki nasączonej płynem do mycia okien. Nie używaj kremów do szorowania ani gąbki do szorowania.

• Czyszczenie stojaków z drutu

Zdemontuj przewody stopniowe, aby je wyczyścić. Podnieś przednią część stopnia; popchnij cały stopień do góry i zwolnij przedni haczyk z obudowy. Następnie delikatnie pociągnij cały stopień do siebie, aby zwolnić tylne zaczepy z ich obudowy. Usuń 2 stopnie.

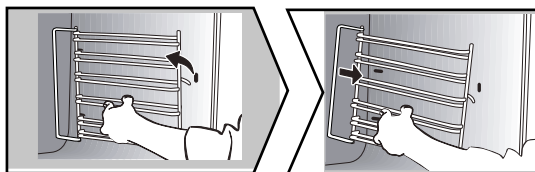

• Czyszczenie szyby drzwi

! **Ostrzeżenie :**

Do czyszczenia szklanych drzwiczek piekarnika nie należy używać żadnych środków do szorowania, szorstkiej gąbki ani metalowych skrobaków, które mogą zarysować powierzchnię i spowodować pęknięcie szkła.

Najpierw usuń nadmiar smaru z szyby wewnętrznej miękką szmatką i płynem do mycia naczyń. Aby wyczyścić różne szyby wewnętrzne, demontuj je w następujący sposób:

• Czyszczenie szyby drzwi

Całkowicie otwórz drzwi i zablokuj je za pomocą plastikowego klina znajdującego się w plastikowej torebce urządzenia.

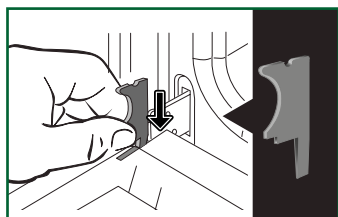

Zdjąć pierwszą przyciętą szybę: wcisnąć narzędziem (śrubokrętem) w miejsca (A) w celu odpięcia szyby, a następnie ją zdjąć.



Ważny:

Upewnij się, że zaznaczyłeś kierunek montażu pierwszego okna (błyszcząca strona do Ciebie)



Dbanie o urządzenie

W zależności od modelu, drzwi składają się z dwóch dodatkowych szyb z czarną gumową przekładką w każdym rogu. W razie potrzeby zdejmij je do czyszczenia.

Nie zanurzaj okien w wodzie. Spłucz czystą wodą i wytrzyj do sucha niestrzępiącą się szmatką.

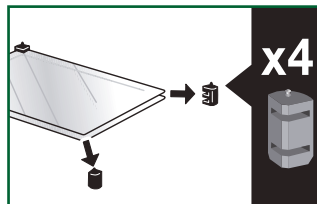
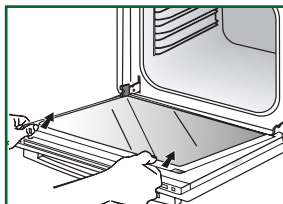
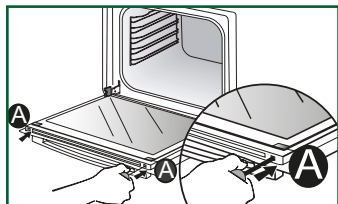

• Montaż okien w drzwiach

Po wyczyszczeniu ustaw ponownie cztery gumowe ograniczniki skierowane w górę i ponownie umieść zespół szyby.

Ostatnią szybę zatrzasknąć w metalowych ogranicznikach, a następnie przypiąć błyszczącą stroną do siebie.

Usunąć plastikowy klin.

Twoje urządzenie znów działa.

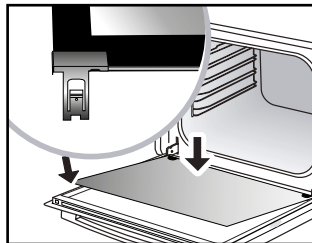
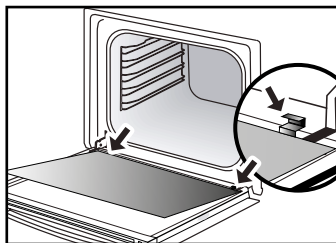
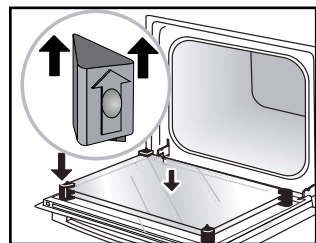

• WYMIANA LAMPKI

Ostrzeżenie

Aby uniknąć ryzyka porażenia prądem elektrycznym, przed przystąpieniem do wymiany lampki należy upewnić się, że urządzenie jest odłączone od zasilania. Należy wykonywać jakiegokolwiek prace dopiero, kiedy urządzenie jest schłodzone.

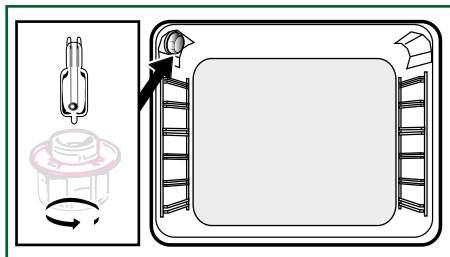

Specyfikacje żarówki:

25 W, 220-240 V~, 300°C, trzonek G9.

Kiedy lampka nie działa, może zostać wymieniona przez użytkownika. Odkręcić szybę i wyjąć lampkę (należy używać gumowych rękawic - ułatwi to przeprowadzenie demontażu). Włożyć nową lampkę i założyć szybę.



ROZWIĄZYWANIE PROBLEMÓW

Piekarnik nie nagrzewa się.

Sprawdź, czy piekarnik jest prawidłowo podłączony lub czy bezpiecznik w Twojej instalacji nie działa. Zwiększ wybraną temperaturę.

Nie działa oświetlenie piekarnika.

Wymień żarówkę lub bezpiecznik. Sprawdź, czy piekarnik jest prawidłowo podłączony.

Wentylator chłodzący działa nadal po zatrzymaniu piekarnika.

Jest to normalne, wentylacja może działać nawet przez godzinę po zakończeniu pieczenia, aby obniżyć wewnętrzną i zewnętrzną temperaturę piekarnika. Po upływie godziny należy skontaktować się z serwisem posprzedażowym.

Czyszczenie pirolizy nie jest wykonywane.

Sprawdź, czy drzwi są zamknięte. Może to być blokada drzwi lub usterka czujnika temperatury. Jeśli usterka nie ustąpi, skontaktuj się z serwisem technicznym.

Symbol miga na wyświetlaczu.

Usterka blokowania drzwi, wezwać serwis.

Wibrujący hałas.

Sprawdź, czy przewód zasilający nie styka się z tylną ścianą.

Nie ma to wpływu na prawidłowe działanie urządzenia, ale mimo to może generować wibrujący dźwięk podczas wentylacji. Usuń urządzenie i przesun przewód. Wymień piekarnik.



SERWIS POSPRZEDAZNY

NAPRAWY

Ewentualne naprawy urządzenia powinny być wykonane przez wykwalifikowanego fachowca z autoryzowanego serwisu marki. Wzywając serwis proszę podać kompletne dane urządzenia (model, typ, numer seryjny). Informacje te znajdują się na tabliczce znamionowej.

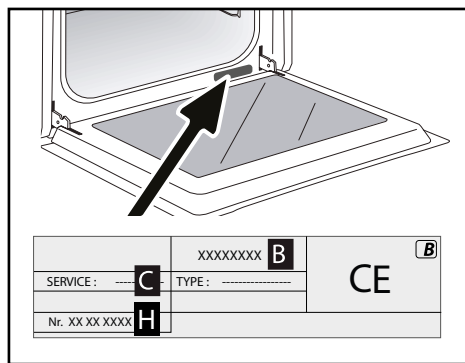

B: odniesienie handlowe
C: Numer referencyjny usługi
H: numer seryjny

ORYGINALNE CZĘŚCI

W czasie wykonywania zabiegów serwisowych należy zażądać użycia wyłącznie oryginalnych części zamiennych.





NACZYNIA	* * * * * * * *														
Mięsa															
Rôti de porc (1kg)	200	2						180	2						60
Rôti de veau (1kg)	200	2						180	2						60-70
Rôti de boeuf	240	2													30-40
Agneau (gigot, épaule 2,5 kg)	220	1			220						200	2			60
Volailles (1 kg)	200	2			220		180	2			210	3			60
Volailles grosses pièces	180	1													60-90
Cuisses de poulet					220	3					210	3			20-30
Côtes de porc / veau					210	3									20-30
Côtes de boeuf (1kg)					210	3					210	3			20-30
Côtes de mouton					210	3									20-30
Ryby															
Poissons grillés					275	4									15-20
Poissons cuisinés	200	3					180	3							30-35
Poissons papillottes	220	3					200	3							15-20
warzywa															
Gratins (aliments cuits)					275	2									30
Gratins dauphinois	200	2					180	2							45
Lasagnes	200	3					180	3							45
Tomates farcies	170	3					160	2							30
Ciasta															
Biscuit de Savoie - Génoise			180	2							180	2			35
Biscuit roulé	220	3									180	2			5-10
Brioche	180	1	210								180	2			35-45
Brownies	180	2					175	3							20-25
Cake - Quatre-quarts	180	1	180	1							180	2			45-50
Clafoutis	200	2					180	3							30-35
Crèmes	165	2									150	2			30-40

* W zależności od modelu



NACZYNIA													
												min	

Ciasta

Cookies - Sablés	175	3															15-20	
Kugelhopf			180	2												180	2	40-45
Meringues	100	2														100	3	60-70
Madeleines	220	3						200	3									5-10
Pâtes à choux	200	3						180	3							180	3	30-40
Petits fours feuilletés	220	3						200	3									5-10
Savarin	180	3														175	3	30-35
Tarte pâte brisée	200	1						195	1									30-40
Tarte pâte feuilletée fine	215	1						200	1									20-25
Tarte pâte à levure	210	1						200	1									10-30

Różnorodny

Brochettes	220	3			210	4												10-15
Pâté en terrine	200	2						190	2									80-100
Pizza pâte brisée	200	2																30-40
Pizza pâte à pain																		15-18
Quiches																		35-40
Soufflé																180	2	50
Tourtes	200	2																40-45
Pain	220							200		220								30-40
Pain grillé	180				275	4-5												2-3

* W zależności od modelu



Wszystkie T ° C i czasy gotowania są podane dla piekarników podgrzanych

Uwaga: Przed włożeniem do piekarnika, wszystkie mięsa muszą pozostać w temperaturze pokojowej przez co najmniej 1 godzinę.

RÓWNOWAŻNOŚĆ: RYSUNKIT °C

°C	30	60	90	120	150	180	210	240	275
Chiffres	1	2	3	4	5	6	7	8	9 maxi



Przepis z drożdżami (w zależności

Składniki:

• Mąka 2 kg • Woda 1240 ml • Sól 40 g • 4 opakowania suszonych drożdży piekarskich
Wymieszaj ciasto mikserem i pozwól, aby ciasto wyrosło w piekarniku.

Procedura: Do receptur makaronu na bazie drożdży. Wlej ciasto do odpornego naczynia podgrzać, wyjąć ruszty i postawić naczynie na dnie.

Rozgrzej piekarnik z funkcją gorącego powietrza do 40-50 ° C przez 5 minut. Zatrzymaj piekarnik i pozostaw ciasto na 25-30 minut, wykorzystując ciepło reszkowe.

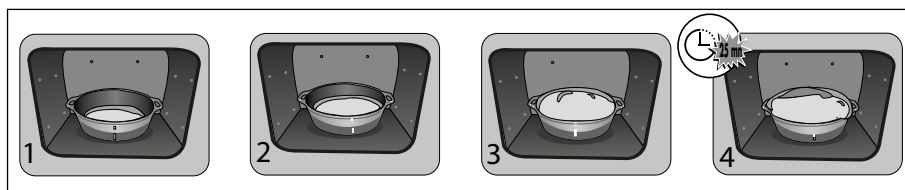



BADANIA PRZYDATNOŚCI FUNKCJONALNEJ WEDŁUG IEC 60350













ALIMENT	*Mode de cuisson	NIVEAU	Accessoires	°C	DUREE min.	PRECHAUF-FAGE
Sablés (8.4.1)		5	plat 45 mm	150	30-40	oui
Sablés (8.4.1)		5	plat 45 mm	150	25-35	oui
Sablés (8.4.1)		2 + 5	plat 45 mm + grille	150	25-45	oui
Sablés (8.4.1)		3	plat 45 mm	175	25-35	oui
Sablés (8.4.1)		2 + 5	plat 45 mm + grille	160	30-40	oui
Petits cakes (8.4.2)		5	plat 45 mm	170	25-35	oui
Petits cakes (8.4.2)		5	plat 45 mm	170	25-35	oui
Petits cakes (8.4.2)		2 + 5	plat 45 mm + grille	170	20-40	oui
Petits cakes (8.4.2)		3	plat 45 mm	170	25-35	oui
Petits cakes (8.4.2)		2 + 5	plat 45 mm + grille	170	25-35	oui
Gâteau moelleux sans matière grasse (8.5.1)		4	grille	150	30-40	oui
Gâteau moelleux sans matière grasse (8.5.1)		4	grille	150	30-40	oui
Gâteau moelleux sans matière grasse (8.5.1)		2 + 5	plat 45 mm + grille	150	30-40	oui
Gâteau moelleux sans matière grasse (8.5.1)		3		150	30-40	oui
Gâteau moelleux sans matière grasse (8.5.1)		2 + 5	plat 45 mm + grille	150	30-40	oui
Tourte aux pommes (8.5.2)		1	grille	170	90-120	oui
Tourte aux pommes (8.5.2)		1	grille	170	90-120	oui
Tourte aux pommes (8.5.2)		3	grille	180	90-120	oui
Surface gratinée (9.2.2)		5	grille	275	3-6	oui

* W zależności od modelu

UWAGA: W przypadku gotowania na 2 poziomach naczynia można wyjmować w różnym czasie.



TABELA FUNKCJI COMBINED AUTOMATYCZNY ZE SKOJARZENIEM PARY

Pozycja joysticka	Wyświetl w programatorze	jedzenie	Ilość wody do dodania
		kurczak	500 ml letniej wody na blasze uniwersalnej
		kaczka	500 ml letniej wody na blasze uniwersalnej
		indyk	500 ml letniej wody na blasze uniwersalnej
		Perliczka	800 ml letniej wody na blasze uniwersalnej
		Cała ryba (duża)	500 ml letniej wody na blasze uniwersalnej
		Cała ryba (płaska)	300 ml letniej wody na blasze uniwersalnej
		Mała cała ryba	300 ml letniej wody na blasze uniwersalnej
		Filety rybne	300 ml letniej wody na blasze uniwersalnej
		Pieczona wieprzowina	500 ml letniej wody na blasze uniwersalnej
		Pieczona cielęcina	500 ml letniej wody na blasze uniwersalnej

WAŻNY

Miskę ociekową (z letnią wodą) umieścić na dolnej półce, poziom 1, a potrawę do pieczenia na poziomie 3.



EN Informații pentru domeniul de aplicare (UE n° 6620/14)
DE Informationen zu Anwendungsbereich (UE n° 6620/14)
FR Informations concernant les fins d'application (UE n° 6620/14)
ES Información sobre los fines de aplicación (UE n° 6620/14)
CS Informační údaje ke záměru aplikace (UE n° 6620/14)
IT Informazioni relative ai fini per cui sono destinati (UE n° 6620/14)
NL Informatie met betrekking tot het doel van de toepassing (UE n° 6620/14)
DA Oplysninger for områder til anvendelse (UE n° 6620/14)
SV Tillämpningsområdesinformation (UE n° 6620/14)

EN	DE	FR	ES	CS	IT	NL	DA	SV													
Information for domestic ovens (UE n° 6620/14)	Informationen zu Haushaltsbacköfen (UE n° 6620/14)	Informations pour fours domestiques (UE n° 6620/14)	Información sobre los hornos domésticos (UE n° 6620/14)	Informační údaje ke záměrům pro domácí použití (UE n° 6620/14)	Informazioni relative ai forni domestici (UE n° 6620/14)	Informatie met betrekking tot huishoudelijke ovens (UE n° 6620/14)	Oplysninger for ovne til husholdningsbrug (UE n° 6620/14)	Tillämpningsområdesinformation (UE n° 6620/14)													
Symbol	Value																				
Type norme	KH725V, KH725U, KH715P, KH725P, KH725T, KH725S, KXD25T, KXD25P	KH725W, KH725V, KH715W, KH715V, KH725W, KH725V, KH715W, KH715V, KH725W, KH725V, KXD25T, KXD25P	KH725W, KH725V, KH715W, KH715V, KH725W, KH725V, KH715W, KH715V, KH725W, KH725V, KXD25T, KXD25P	KH725W, KH725V, KH715W, KH715V, KH725W, KH725V, KH715W, KH715V, KH725W, KH725V, KXD25T, KXD25P	KH725W, KH725V, KH715W, KH715V, KH725W, KH725V, KH715W, KH715V, KH725W, KH725V, KXD25T, KXD25P	KH725W, KH725V, KH715W, KH715V, KH725W, KH725V, KH715W, KH715V, KH725W, KH725V, KXD25T, KXD25P	KH725W, KH725V, KH715W, KH715V, KH725W, KH725V, KH715W, KH715V, KH725W, KH725V, KXD25T, KXD25P	KH725W, KH725V, KH715W, KH715V, KH725W, KH725V, KH715W, KH715V, KH725W, KH725V, KXD25T, KXD25P													
Mode(s) identification																					
Type of oven	Simple	FR: Simple / CS: Jednoduchá / DE: Einfach / ES: Simple / IT: Semplice / NL: Simple / DA: Enkelt / SV: Enkelt																			
Mass of the appliance	M	34,6	30,7	35,7	33,6	36,2	36,6	36,0	36,0	34,1	31,1	1	1	1	1	1	1	1			
Number of cavities		1	1	1	1	1	1	1	1	1	1	1	1	1	1	1	1	1			
Heat source per cavity (type of fuel or gas)	FR: Electricité / CS: Elektrická / DE: Strom / ES: Electricidad / IT: Energia elettrica / NL: Elektriciteit / DA: Elektricitet / SV: Elektricitet																				
Volume per cavity	V	730	730	730	730	730	730	730	730	730	730	730	730	730	730	730	730	730	730		
Energy consumption (mode per cavity) required to heat a standardised load in a heated oven during a cycle in fan-forced mode per cavity (electric final energy)	EC	0,82	0,82	0,89	0,79	0,79	0,79	0,79	0,79	0,79	0,79	0,79	0,79	0,79	0,79	0,79	0,79	0,79	0,79	0,79	
Energy efficiency index per cavity	EEl	90,3	86,3	80,2	81,4	81,4	81,4	81,4	81,4	81,4	81,4	81,4	81,4	81,4	81,4	81,4	81,4	81,4	81,4	81,4	81,4

FR

DA

DE

EL

EN

ES

FI

IT

NL

PL

PT

SK

SV

Brandt



INSTRUÇÕES DO USUÁRIO PT

FORNO

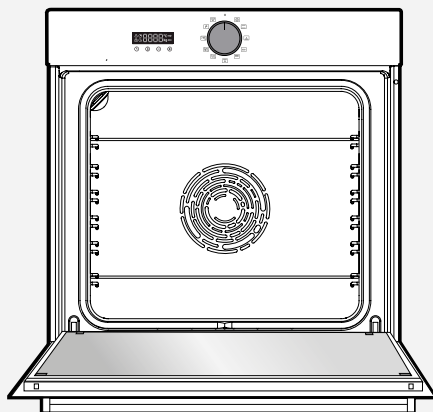

ORIGINE
FRANCE[®]
GARANTIE

BVCert.6011825

Caro(a) cliente,

Acaba de adquirir um produto **BRANDT** e agradecemos a confiança que depositou em nós.

Desenhámos e fabricámos este produto pensando em si, no seu modo de vida e nas suas necessidades, para poder responder da melhor forma possível às suas expectativas. Usámos o nosso conhecimento especializado, o nosso espírito inovador e toda a paixão que nos motiva desde há mais de 60 anos.

Com a preocupação constante de melhor satisfazer as suas exigências, o nosso serviço ao consumidor está à sua disposição para responder a todas as suas dúvidas ou sugestões.

Visite também o nosso site www.brandt.com onde encontrará as mais recentes inovações, bem como informação útil e complementar.

A BRANDT tem o prazer de acompanhá-lo(a) na sua vida quotidiana e espera que desfrute da sua compra da melhor forma possível.

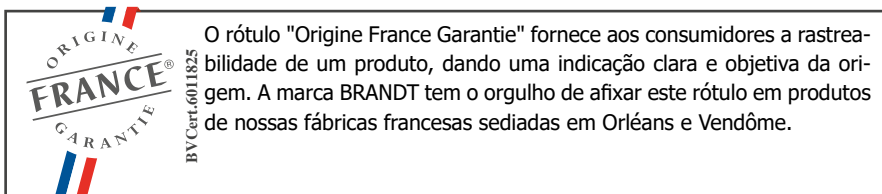

<https://brandt.fr/>

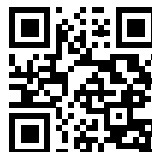

Importante:

Antes de ligar o seu aparelho, leia com atenção este guia de instalação e utilização, para se familiarizar mais rapidamente com o seu funcionamento.



INSTRUÇÕES DE SEGURANÇA	4
MEIO AMBIENTE E ECONOMIA DE ENERGIA	6
Meio Ambiente	6
Dica de economia de energia	6
INSTALANDO SEU APARELHO	7
Escolha de localização e instalação	7
Conexão elétrica	8
DESCRIÇÃO DO SEU APARELHO	9
Apresentação do forno	9
Display e teclas de controle	9
Acessórios	10
USANDO SEU DISPOSITIVO	12
Configurações	12
Menu de configurações	13
Modos de cozinha	14
Começando a cozinhar	15
CUIDANDO DO SEU DISPOSITIVO	17
Interior - limpeza exterior	18
ANOMALIAS E SOLUÇÕES	19
SERVIÇO PÓS-VENDA	21
Intervenções	21
AJUDA DE COZINHA	21
Gráficos de culinária	22
Receitas com fermento	24
Testes de aptidão funcional	25
Funções com vapor combinado automático.....	26



INSTRUÇÕES DE SEGURANÇA IMPORTANTES LER COM ATENÇÃO E CONSERVAR PARA FUTURA UTILIZAÇÃO.

Este manual está disponível para download no sítio Internet da marca.

Quando receber o aparelho, desembale-o ou peça a alguém para o desembalar imediatamente. Verifique o seu aspeto geral. Faça todas as eventuais indicações por escrito na nota de entrega e guarde um exemplar da mesma.

Importante:

Este aparelho pode ser utilizado por crianças com 8 anos ou mais, e por pessoas com capacidades físicas, sensoriais ou mentais reduzidas, ou desprovidas de experiência e conhecimentos, se beneficiarem de uma supervisão ou de instruções prévias acerca da utilização do aparelho de maneira segura e tiverem entendido os riscos corridos.

— As crianças não devem brincar com o aparelho. As operações de limpeza e de manutenção não devem ser realizadas por crianças sem supervisão.

— Convém supervisionar as crianças, para se certificar de que estas não brincam com o aparelho.

CUIDADO:

— O aparelho e as suas peças acessíveis ficam quentes

durante a utilização. Não toque nos elementos de aquecimento que se encontram no interior do forno. Crianças de menos de 8 anos devem ser mantidas afastadas, a menos que sejam constantemente supervisionadas.

— Este aparelho foi criado para fazer cozeduras com a porta fechada.

— Antes de proceder à limpeza por pirólise do forno, retire todos os acessórios e remova os derrames maiores.

— Na função de limpeza, as superfícies podem ficar mais quentes que durante a utilização normal.

Recomendamos que mantenha as crianças afastadas.

— Não utilize aparelhos de limpeza a vapor.

— Não utilize produtos de limpeza abrasivos ou raspadores metálicos duros para limpar a porta em vidro do forno, pois isso pode riscar a superfície e dar origem à ruptura do vidro.

ADVERTÊNCIA :

Certifique-se de que o aparelho



está desligado da alimentação antes de substituir a lâmpada, para evitar qualquer risco de choques eléctricos. Intervenha quando o aparelho estiver frio. Para desapertar a tampa e a lâmpada, utilize uma luva de borracha para facilitar a desmontagem.

A ficha da tomada de corrente deve estar acessível após a instalação. Deve ser possível se desconectar da rede ou utilizar uma folha de fazer atual, ou pela incorporação de um interruptor nas canalizações fixas, de acordo com as regras de instalação.

— Se o cabo da alimentação ficar danificado, deverá ser substituído pelo fabricante, o serviço pós-venda, ou uma pessoa igualmente habilitada, de modo a evitar qualquer perigo.

— Este aparelho pode ser instalado numa bancada ou em coluna, conforme indicado no esquema de instalação.

— Centre o forno no móvel, de modo a garantir uma distância mínima de 10 mm com o móvel ao lado. O material do móvel de encastramento deve resistir ao calor (ou estar revestido com um material resistente ao calor). Para mais estabilidade, fixe o forno no móvel com 2 parafusos, através

dos orifícios previstos para o efeito.
— O aparelho não deve ser instalado atrás de uma porta decorativa, para evitar o seu superaquecimento.

— Este aparelho destina-se a ser utilizado em aplicações domésticas e análogas, tais como: áreas de cozinha reservadas ao pessoal de lojas, escritórios e outros ambientes profissionais; quintas; utilização por clientes de hotéis, motéis e outros ambientes de carácter residencial; em ambientes do tipo quarto de hotel.

— Para qualquer intervenção de limpeza na cavidade do forno, este deverá estar desligado.

Não deve modificar as características do aparelho, pois isto representa um perigo para si.

Não utilize o seu forno para guardar comida ou quaisquer outros elementos após a utilização.



RESPEITO PELO MEIO AMBIENTE

Os materiais da embalagem deste aparelho são recicláveis. Participe na sua reciclagem contribuindo para a proteção do meio ambiente, eliminando-os nos contentores municipais previstos para o efeito.



O seu aparelho também contém vários materiais recicláveis. Assim, inclui este logótipo para indicar que os aparelhos usados não devem ser misturados com outros resíduos.

Assim, a reciclagem de aparelhos usados do fabricante será realizada nas melhores condições, em conformidade com a Diretiva Europeia 2002/96/CE em matéria de equipamentos elétricos e eletrónicos.

Consulte a sua câmara municipal ou o seu revendedor quanto aos pontos de recolha dos aparelhos usados mais próximos da sua habitação.

Agradecemos a sua colaboração na proteção do meio ambiente.

DICA DE ECONOMIA DE ENERGIA

Enquanto cozinha, mantenha a porta do forno fechada.



ESCOLHA DE POSICIONAMENTO E ENCASTRAMENTO

Os esquemas acima determinam as cotas de um móvel que permitirá receber um forno.

Este aparelho pode ser instalado em bancada (A) ou em coluna (B). Se o móvel for aberto, a sua abertura deverá ser no máximo de 70 mm na parte traseira (C et D). Fixe o forno dentro do móvel. Para este efeito, retire os batentes em borracha e faça um orifício de $\varnothing 2$ mm na parede do móvel, para evitar a ruptura da madeira. Fixe o forno com os 2 parafusos. Volte a colocar os batentes em borracha.



Conselho

De modo a certificar-se de que a sua instalação está conforme, não hesite em contactar um especialista em electrodomésticos.



Cuidado :

Se a instalação elétrica em sua casa exigir modificações para conectar seu aparelho, chame um electricista qualificado. Se o forno apresentar alguma anomalia, desligue o aparelho ou retire o fusível correspondente à linha de ligação do forno.

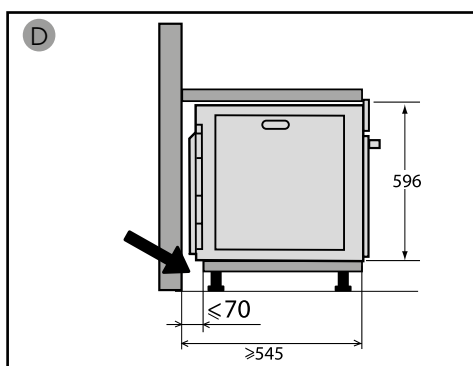
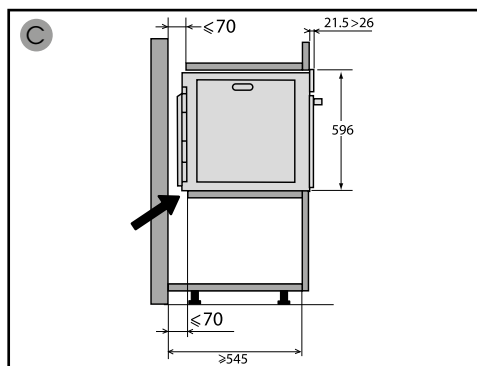
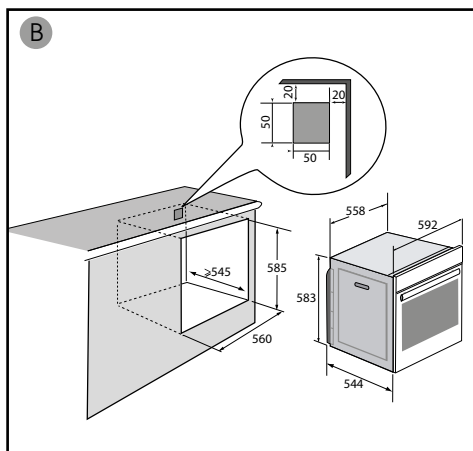
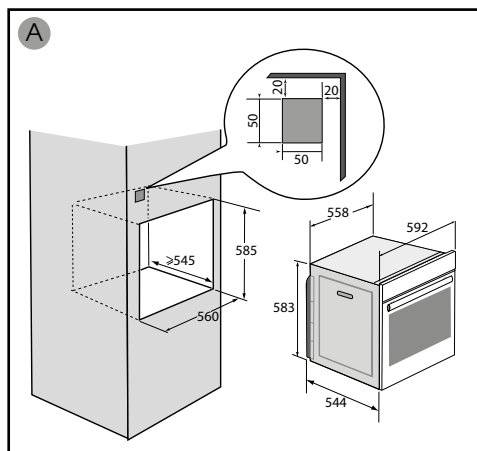



LIGAÇÃO ELÉTRICA

O forno deve ser ligado com um cabo de alimentação (normalizado) de 3 condutores de 1,5mm² (1ph + 1 N + terra) devendo estes ser ligados à rede monofásica de 220-240V~ através de uma tomada de corrente normalizada CEI 60083 ou de um dispositivo de corte omipolar em conformidade com as regras de instalação.

Attention

O fio de proteção (verde-amarelo) está ligado ao terminal \oplus do aparelho e deve ser feita uma ligação à terra. O fusível da instalação deve ser de 16 amperes.

Não nos responsabilizaremos em caso de acidente ou incidente resultante de uma ligação à terra inexistente, defeituosa ou incorreta nem em caso de uma desconexão não conforme.

• Antes do primeiro uso

Antes de utilizar o seu forno pela primeira vez, aqueça-o vazio, com a porta fechada, durante cerca de 15 minutos na temperatura máxima. para quebrar o dispositivo. A lã mineral que envolve a cavidade do forno pode inicialmente exalar um odor particular devido à sua composição. Da mesma forma, você pode notar fumaça. Tudo isso é normal.

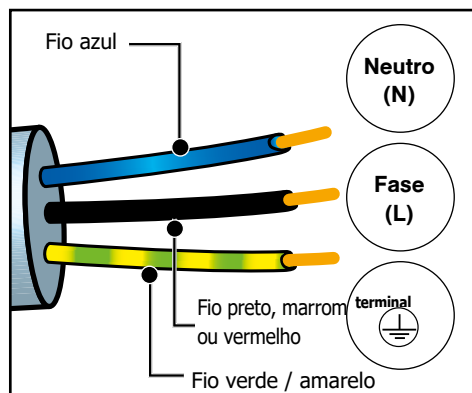



Apresentação do forno

APRESENTAÇÃO DO FORNO

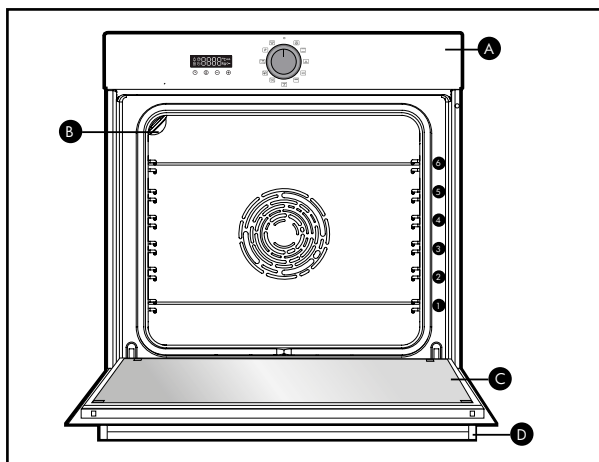

A Módulo de comandos

B Lâmpada

C Porta

D Pega

Este forno tem 6 posições de encaixes para os acessórios: encaixes de 1 a 6.

• Indicador



- Duração da cozedura
- Fim da cozedura
- Bloqueio do teclado
- Temporizador
- Indicador de temperatura
- Indicador de preaquecimento
- Bloqueio da porta

• Botões

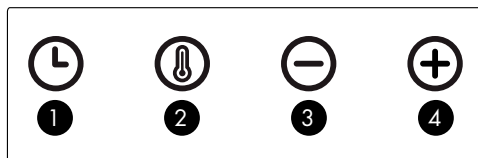

- 1** Ajuste da hora e duração
- 2** Ajuste da temperatura
- 3** Botão -
- 4** Botão +



ACESSÓRIOS

• Grelha de segurança anti-inclinação

A grelha pode ser utilizada para colocar os pratos e formas com alimentos a cozer ou gratinar. Será utilizada para fazer grelhados (colocando-os diretamente sobre a grelha).

Introduzir a grelha, a pega anti-inclinação na direção do fundo do forno.

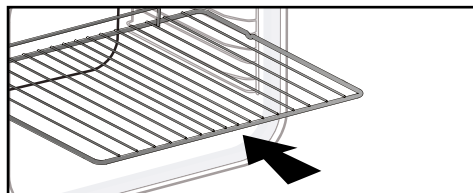

• Prato multiusos com pingadeira de 45 mm

Inserido nos níveis abaixo da grelha, pega na direção da porta do forno. Recolhe o sumo e gorduras dos grelhados. Pode ser utilizada meia de água para cozeduras em banho-maria.

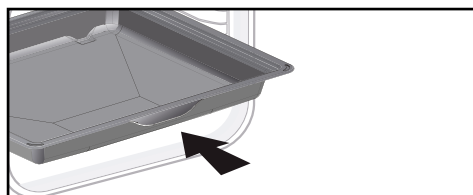

• Prato de pastelaria de 20 mm

Inserido nos encaixes, pega na direção da porta do forno. Ideal para a cozedura de biscoitos, bolachas areadas, cupcakes. O plano inclinado permite colocar facilmente as preparações num prato. Também pode ser inserido nos encaixes abaixo da grelha para recolher os sumos e gorduras de grelhados.

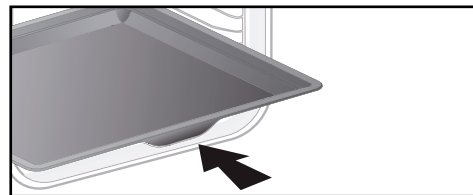

• Sistema de guias deslizantes

Graças ao sistema de calhas deslizantes, a manipulação dos alimentos torna-se mais prática e fácil, pois as placas podem ser retiradas suavemente, o que simplifica ao máximo a sua manipulação. As placas podem ser retiradas por completo, o que permite aceder-lhes totalmente.

Além disso, a sua estabilidade permite trabalhar e manipular os alimentos com toda a segurança, o que reduz o risco de queimaduras. Deste modo, pode retirar os seus alimentos do forno muito mais

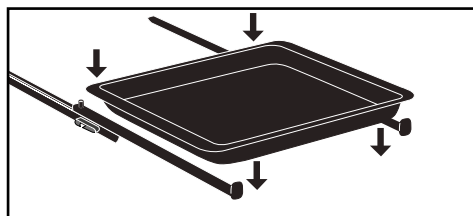

Cuidado :

etire os acessórios e os encaixes do forno antes de iniciar uma limpeza por pirólise.

Cuidado :

Sob o efeito do calor, os acessórios podem se deformar sem afetar sua função. Eles voltam à sua forma original quando resfriados.



INSTALAÇÃO E DESMONTAGEM DAS GUIAS DESLIZANTES

Depois de retirar os dois encaixes de filamento, escolha a altura dos encaixes (de 2 a 5) a que deseja fixar as guias. Acione a guia esquerda contra o encaixe esquerdo efetuando uma pressão suficiente na parte dianteira e traseira da guia para que as 2 pernas laterais da guia entrem no encaixe de filamento. Proceda da mesma forma para a guia direita.

NOTA: a parte deslizante telescópica da guia deve desdobrar-se na direção da parte anterior do forno, e o batente **A** à sua frente.

Coloque os 2 encaixes de filamento e em seguida, coloque o tabuleiro sobre as 2 guias; o sistema está pronto a ser utilizado.

Para desmontar as guias, retire novamente os encaixes de filamento.

Remova ligeiramente os pés fixos sobre cada guia, para baixo, para os libertar do encaixe. Puxe a guia na sua direção.

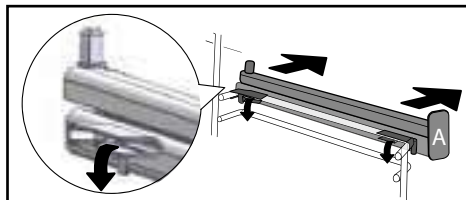
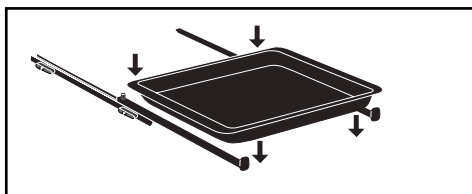
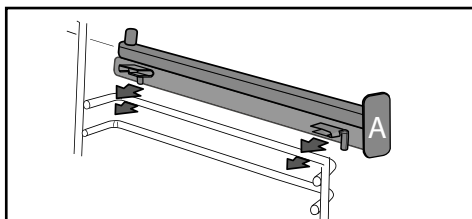

Conselho

Para evitar a libertação de fumo durante a cozedura de carnes gordas, recomendamos juntar um pouco de água ou óleo no fundo da pingadeira.



Usando seu dispositivo

AJUSTES

• Acertar a hora

Quando se liga, o visor pisca e mostra 12:00.

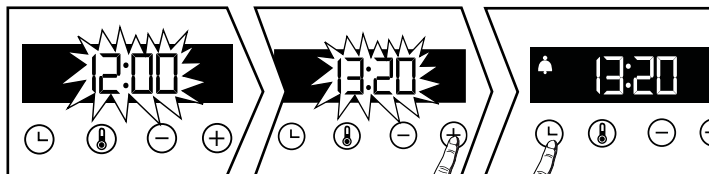

Ajustar a hora com os botões + ou -.Valide com o botão . No caso de corte de energia, a hora começa a piscar.

• Mudança da hora

O seletor de função deve obrigatoriamente estar na posição 0.

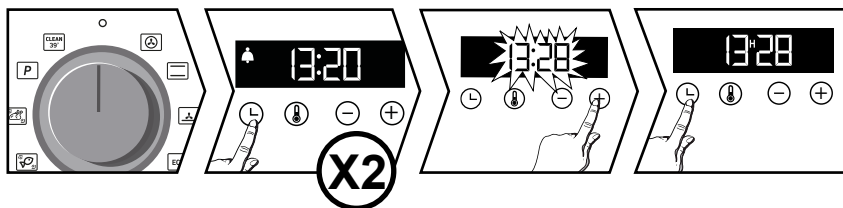

Prima o botão e aparece o símbolo bastando depois premir novamente . Ajustar a hora com os botões + ou -.Valide com o botão . A gravação da hora é automática, depois de alguns segundos.

• Temporizador

Esta função não pode ser utilizada com o forno desligado.

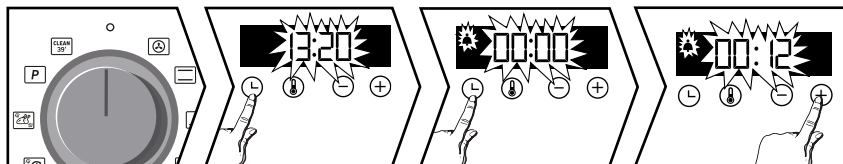

O seletor de função deve obrigatoriamente estar na posição 0.



Prima o botão O temporizador pisca. Ajuste o temporizador com os botões + et -.Prima o botão para validar.

NB: Tem a possibilidade de modificar ou anular a programação do temporizador a qualquer altura. Para anular, volte ao menu do temporizador e ajuste em 00:00. Sem validar, a gravação é efetuada automaticamente após alguns segundos.

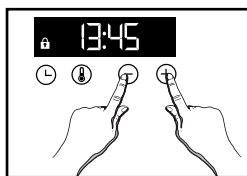

• Bloqueio do teclado



Prima simultaneamente os botões + e - até aparecer o símbolo  no ecrã. Para desbloquear, prima simultaneamente os botões + e - até o símbolo  desaparecer do ecrã.

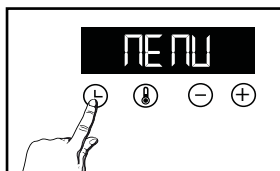

AJUSTES

Pode intervir em diferentes parâmetros do forno; para tal: Pressione o botão  até aparecer «MENU» para aceder ao modo de acerto.



Prima novamente o botão  para ver os diferentes acertos.

Ative ou desative com os botões + e - os diferentes parâmetros, consultando a tabela abaixo:

	AUTO: No modo de cozedura, a lâmpada da cavidade apaga-se depois de 90 segundos ON: No modo de cozedura, a lâmpada está sempre acesa.
	Ativar/desativar os sinais sonoros dos botões
	Ativar/desativar o modo de pré-aquecimento
	Ativar/desativar o modo de demonstração

Para sair de «MENU», prima novamente .



Usando seu dispositivo

MODOS DE COZEDURA

Funções manuais:



CALOR VENTILADO*

Temperatura mínima de 35°C e máxima de 250°C

Recomendado para manter a tenrura de carnes brancas, peixes e legumes. Para as cozaduras múltiplas até 3 níveis.



TRADICIONAL

Temperatura mínima de 35°C e máxima de 275°C

Recomendado para cozaduras lentas e delicadas: animais de caça tenros. Para fazer assados de carnes vermelhas. Para engrossar numa panela tapada, para pratos preparados anteriormente sobre a placa (coq au vin, civet).



BASE PULSADA

Temperatura mínima de 75°C e máxima de 250°C

Recomendado para pratos húmidos (quiches, tartes de fruta suculenta, etc.). A massa ficará bem cozida por baixo. Recomendado para preparações levedadas (bolo, brioche, folar, etc.) e para soufflés que não sejam tapados com uma côdea.



ECO*

Temperatura mínima de 35°C e máxima de 275°C

Esta posição permite ganhar energia conservando as qualidades da cozadura.

Todas as cozaduras são feitas sem preaquecimento.



GRELHA FORTE

Temperatura mínima de 180°C e máxima de 275°C

Recomendados para grelhar tosta, gratinar um prato, dourar um leite creme...



GRELHA PULSADA

Temperatura mínima de 100°C e máxima de 250°C

Aves e assados suculentos e estaladiços em todos os lados. Deslize a pingadeira para o nível inferior. Recomendado para todas as carnes de ave e assados, para tostar ou cozer na perfeição pernas de borrego, costeletas de vaca. Para manter o sabor nas pastas de peixe.

Funções automáticas :

A Brandt oferece 3 novas funções que combinam de forma automática dois modos de cozadura: a cozadura tradicional e a cozadura a vapor para preservar as qualidades nutricionais dos alimentos e obter uma cozadura mais rápida.



CARNE BRANCA

Recomendado para conservar a parte mais suave e o caldo dos assados de porco e vitela.



PEIXE

Recomendado para a cozadura de peixes inteiros ou em filetes.



AVES

Recomendado para a cozadura de frango, peru, galinha pintada e pato.

Para estas 3 funções, basta introduzir água morna em quantidade suficiente no prato (pingadeira) e posicioná-la no forno na grelha de baixo e o alimento a cozinhar na grelha do nível 3.

Relativamente à quantidade de água a introduzir na pingadeira, consulte a tabela de funções combinadas automáticas com associação de vapor no fim do manual.



"Smart Assist"

O forno está equipado com a função "SMART ASSIST" que predefine, depois da programação da duração, uma duração de cozadura modificável consoante o modo de cozadura selecionado.

**Modo de cozadura realizado de acordo com as prescrições da norma EN 60350-1 : 2016 para demonstrar a conformidade com as exigências de etiquetagem energética do regulamento europeu UE/65/2014.*



COMEÇANDO A COZINHAR

• Cozedura imediata

O programador deve apresentar apenas a hora. Esta não deve estar a piscar. Gire o seletor de funções para a posição desejada.

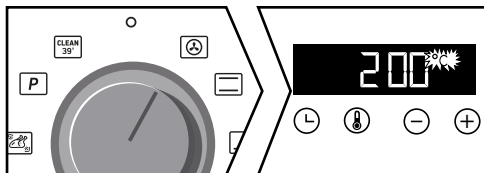



Para as funções manuais :

A subida de temperatura começa imediatamente. O forno tem uma temperatura predefinida, que pode ser alterada. O forno aquece e o indicador de temperatura pisca. Quando o forno atingir a temperatura programada, ouvirá uma série de sons.

Para as funções automáticas :

 aparece no ecrã.

Selecione o alimento a cozinhar com a ajuda da tabela no fim do manual. Pressione os botões + e - até obter o esquema desejado no ecrã e depois, valide com o botão .

O peso pisca; volte a introduzir o peso real do alimento com os botões + e - e depois, valide . Não precisa de configurar mais nada. A temperatura e a duração de cozedura são calculadas automaticamente. A hora de fim de cozedura pisca, valide com o botão . A cozedura arranca imediatamente.



• MODIFICAÇÃO DA TEMPERATURA

Pressione .

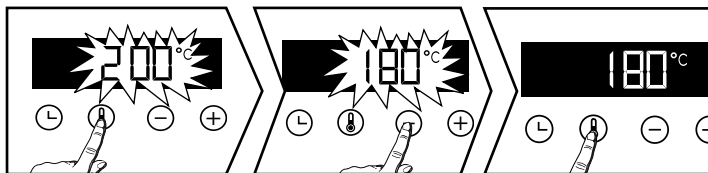
Ajuste a temperatura com + ou -. Valide premindo .



• Programação da duração

Faça uma cozedura imediata e em seguida, pressione , a duração da cozedura  pisca e torna-se possível efetuar o acerto. Pressione + ou - para ajustar a duração da cozedura.

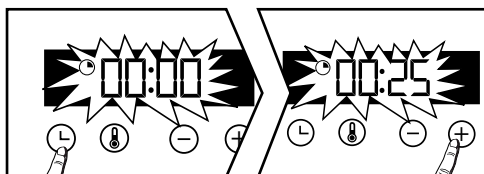



"Smart Assist"



O forno está equipado com a função "SMART ASSIST" que predefine, depois da programação da duração, uma duração de cozedura modificável consoante o modo de cozedura selecionado.

Consulte a tabela abaixo:

A memorização do tempo de cozedura é automática após alguns segundos. A contagem da duração é feita imediatamente após ter sido atingida a temperatura de cozedura.

F U N Ç Ã O DE COZEDURA	PREDEFINIÇÃO DE TEMPO
	30 min
	30 min
	30 min
	30 min
	7 min
	15 min

• Cozedura com início diferido

Proceda como para uma duração programada. Após ajustar a duração da cozedura, prima o botão , e a hora de fim de cozedura pisca .

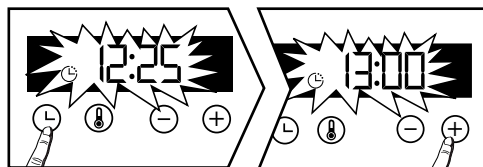

O indicador pisca, ajuste a hora de fim da cozedura com + ou -.

A memorização do fim da cozedura é automática após alguns segundos. O visor do fim da cozedura deixa de piscar.



LIMPEZA DA SUPERFÍCIE EXTERIOR



• Limpeza por pirólise

Atenção

Retire os acessórios e os encaixes do forno antes de efetuar uma limpeza pirolítica. Antes de efetuar uma limpeza pirolítica ao seu forno, retire qualquer excesso presente. Retire o excesso de gordura da porta com a ajuda de uma esponja húmida.

Por segurança, a operação de limpeza pirolítica apenas se efetua após o bloqueio automático da porta, sendo impossível desparafusar a porta.

• Autolimpeza imediata

O programador deve indicar a hora do dia, sem piscar. Selecione um dos ciclos de autolimpeza com o manípulo de funções  ou  :

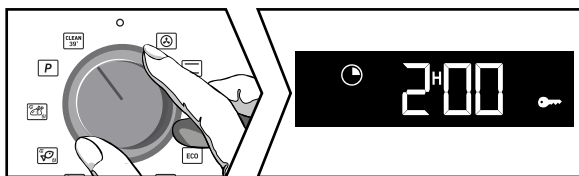





= **Limpeza em 39 minutos**

- Em cada fim de cozedura, aparece no ecrã "Clean 39" para sugerir o início da limpeza. Posicione o manípulo sobre esta função e confirme com o botão . Aparece a duração 0:39 alternando com "Clean 39" e a limpeza começa. Depois de alguns minutos, aparece uma chave, a porta do forno fica bloqueada automaticamente por segurança durante todo o programa.

Se quiser iniciar um programa "Clean 39" com forno frio ou sem estar suficientemente quente, as condições de arranque do programa não permitirão esta limpeza. Aparece 0:00 no ecrã, deverá selecionar a outra posição de autolimpeza  .

 = Limpeza pirolítica de 2 horas ou de 1 hora e 30 minutos, à escolha. Posicione o manípulo sobre esta



Posicione o manípulo sobre esta função.  aparece no ecrã. Pressione + para escolher a limpeza pirolítica em função do grau de sujidade do forno.

Conforme a sua seleção, aparece a duração 2:00 (ou 1:30). Valide com o botão .  (ou ) aparece e a limpeza pirolítica arranca.

No fim da limpeza, o indicador indica 00:00 e a porta desbloqueia-se.

Coloque o seletor de funções em 0.

• Autolimpeza diferida

Tem a possibilidade de ter um arranque diferido da limpeza pirolítica. Quando a duração do programa aparecer no ecrã, prima o botão  e configure a nova hora de fim com os botões + e - e depois, valide com . A autolimpeza arranca posteriormente para terminar à nova hora programada. Reponha o seletor de funções a 0 no final da limpeza.



Limpeza

• Limpeza da superfície exterior

Utilize um pano macio, embebido com um produto limpa-vidros. Não utilize cremes abrasivos nem esfregonas.

• Desmontagem dos encaixes

Levante a parte anterior do encaixe de filamento em direção ao alto e coloque o conjunto do encaixe fazendo sair o gancho antes do compartimento do mesmo. Depois, puxe ligeiramente o conjunto do encaixe na sua direção para retirar os ganchos traseiros dos seus compartimentos. Deste modo, retire os 2 encaixes.

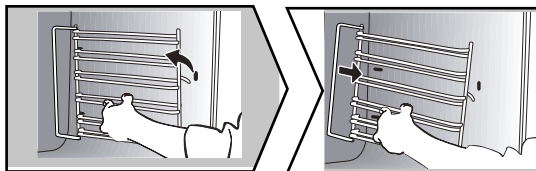

• Limpeza dos vidros interiores



Cuidado

Não utilize produtos de limpeza abrasivos ou raspadores metálicos duros para limpar a porta em vidro do micro-ondas, pois isso pode riscar a superfície e levar à rutura do vidro.

Para limpar os vidros interiores, desmonte a porta. Antes de desmontar os vidros, retire o excesso de gordura do vidro interior com a ajuda de um pano macio e detergente da loiça.

• Limpando o vidro da porta

Abra completamente a porta e bloqueie-a com a ajuda de uma calha em plástico, fornecida na bolsa de plástico do seu aparelho.

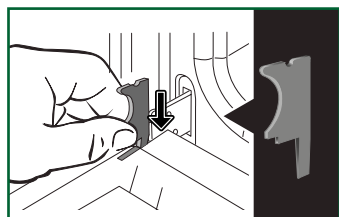

Pressione com a ajuda de uma ferramenta (aparafusadora) nos encaixes **A** para retirar o vidro. Retire o vidro.



Cuidado

Certifique-se de marcar a direção de montagem desta primeira janela (lado brilhante voltado para você)



Limpeza

Consoante o modelo, a porta é composta por dois vidros suplementares com um espaçador preto de borracha em cada canto. Se necessário, retire-os para os limpar.

Não imirja o vidro em água. Lave com água limpa e limpe com um pano que não perca pêlos.

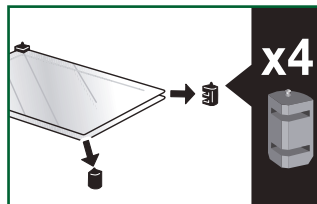
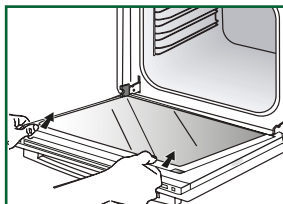
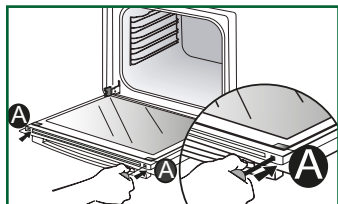

• Nova montagem da porta

Após a limpeza, reposicione os quatro batentes em borracha com a seta para cima e reposicione todos os vidros.

Coloque o vidro nos batentes metálicos e em seguida, fixe-o com a face brilhante virada para o exterior. Retire a calha de plástico.

O seu aparelho está novamente operacional.

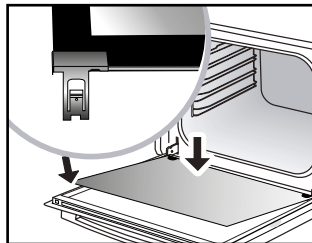
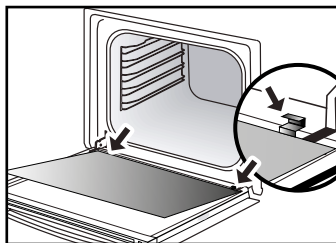
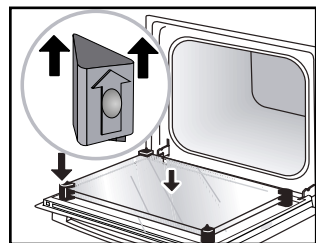

• Substituição da lâmpada



Cuidado:

Certifique-se de que o aparelho está desligado da alimentação antes de substituir a lâmpada, para evitar qualquer risco de choques elétricos. Intervenha quando o aparelho estiver frio.

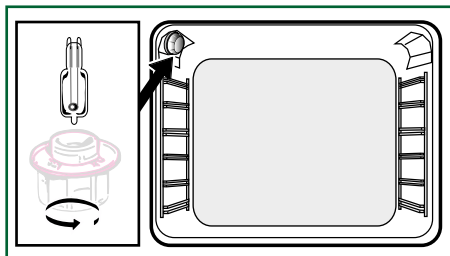

Características da lâmpada:

25 W, 220-240 V~, 300°C, culot G9.

Para desapertar a tampa e a lâmpada, utilize uma luva de borracha para facilitar a desmontagem.



RESOLUÇÃO DE AVARIAS

O forno não aquece. Verifique se o forno está bem ligado ou se o fusível da instalação não está fora de serviço. Aumente a temperatura seleccionada.

A lâmpada do forno não funciona. Substitua a lâmpada ou o fusível. Verifique se o forno está bem conectado.

O ventilador de arrefecimento continua a girar depois do forno apagado.

É normal, a ventilação pode funcionar até uma hora no máximo após a cozedura, para fazer baixar a temperatura interior e exterior do forno. Depois de uma hora, deve contactar o serviço de assistência pós-venda.

A limpeza por pirólise não é feita.

Verifique se a porta está fechada. Trata-se de uma avaria no bloqueio da porta ou do captador de temperatura; deve contactar o serviço de assistência pós-venda.

O símbolopisca  no visor.

Avaria no bloqueio da porta; deve contactar o serviço de assistência pós-venda.

Ruído vibratório.

Verifique se o cabo de alimentação não está em contato com a parede traseira.

Isso não tem impacto sobre o funcionamento correto do dispositivo, mas pode gerar um ruído de vibração durante a ventilação. Remova seu dispositivo e mova o cabo. Substitua o seu forno.



INTERVENÇÕES

As eventuais intervenções no seu aparelho devem ser efetuadas por um profissional qualificado que trabalhe para a marca. Aquando da sua chamada, para facilitar o processamento do seu pedido, deve munir-se com as referências completas do seu aparelho (referência comercial, referência de serviço, número de série). Estas informações figuram na placa informativa.

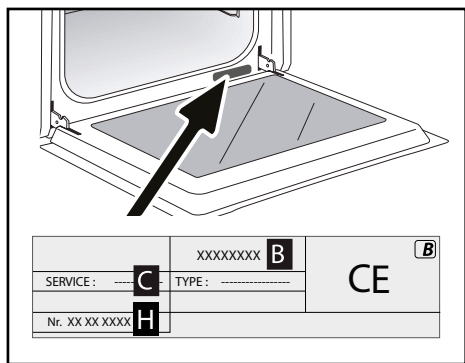

- B: Referência comercial
- C: Referência de serviço
- H: Número de série

PEÇAS DE ORIGEM

Durante uma intervenção de manutenção, peça para utilizar exclusivamente **peças de substituição certificadas de origem**.





PRATOS	* * * * * * *												min
Carnes													
Assado de porco (1 kg)	200	2					180	2					60
Assado de vitela (1 kg)	200	2					180	2					60-70
Lombo de vaca assado	240	2											30-40
Borrego (perna, costela, 2,5 kg)	220	1			220					200	2		60
Aves (1 kg)	200	2			220		180	2			210	3	60
Grandes pedaços de aves	180	1											60-90
Coxas de frango					220	3				210	3		20-30
Costeleta de porco/vitela					210	3							20-30
Costeletas de vaca (1 kg)					210	3				210	3		20-30
Costeletas de carneiro					210	3							20-30
Peixes													
Peixe grelhado						4							15-20
Peixe cozinhado	200	3					180	3					30-35
Peixe em papilote	220	3					200	3					15-20
Legumes													
Gratinados (alimentos cozinhados)					275	2							30
Batatas gratinadas	200	2					180	2					45
Lasanha	200	3					180	3					45
Tomates recheados	170	3					160	2					30
Bolos													
Pão-de-ló - Bolo Génoise			180	2							180	2	35
Torta	220	3									180	2	5-10
Brioche	180	1	210								180	2	35-45
Brownies	180	2					175	3					20-25
Pão de ló	180	1	180	1							180	2	45-50
Clafouti	200	2					180	3					30-35
Cremes	165	2									150	2	30-40

* Consoante o modelo



PRATOS	* * * * * * *												min		
Bolos															
Madalenas	220	3						200	3					5-10	
Massa dos sonhos	200	3						180	3				180	3	30-40
Petiscos de massa folhada	220	3						200	3						5-10
Savarin	180	3											175	3	30-35
Tarte de massa quebrada	200	1						195	1						30-40
Tarte de massa folhada fina	215	1						200	1						20-25
Tarte de massa com fermento	210	1						200	1						10-30
Diversos															
Espetadas	220	3			210	4									10-15
Paté em terrina	200	2						190	2						80-100
Pizza de massa quebrada	200	2													30-40
Pizza de massa de pão															15-18
Quiches															35-40
Soufflé													180	2	50
Tortas	200	2													40-45
Pão	220							200		220					30-40
Pão grelhado	180				275	4-5									2-3
Tachos fechados (ensopado)	180	2											180	2	90-180

* Consoante o modelo



Todas as temperaturas e tempos de cozedura são dados para fornos pré-aquecidos

N.B: Antes de serem colocadas no forno, todas as carnes devem ficar pelo menos uma hora à temperatura ambiente.

EQUIVALÊNCIA: VALORES T °C

°C	30	60	90	120	150	180	210	240	275
Valores	1	2	3	4	5	6	7	8	9 max



Receita com fermento (consoante o modelo)

Ingredientes:

- Farinha 2 kg
 - Água 1240 ml
 - Sal 40 g
 - 4 pacotes de fermento de padeiro desidratado
- Misturar a massa com a batedeira e deixar levedar no forno.

Procedimento: Para as receitas de massas com fermento. Verter a massa num prato resistente ao calor, retirar os suportes dos encaixes e colocar o prato no fundo.

Pré-aquecer o forno com a função de calor ventilado a 40-50°C durante 5 minutos. Desligar o forno e deixar levedar a massa durante 25-30 minutos graças ao calor residual.

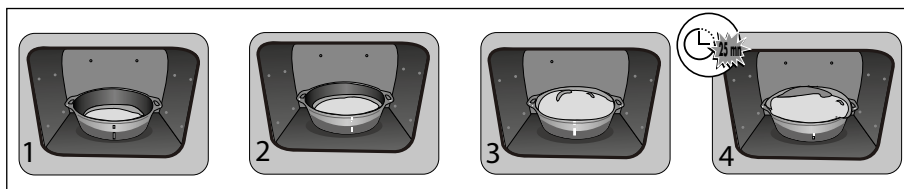



ENSAIOS DE APTIDÃO PARA A FUNÇÃO SE- GUNDO A NORMA IEC 60350

ALIMENTO	* Modos de cozedura	ENCAIXE	ACESSORIOS	T°C	TEMPO	Pré-aquecimento
Bolos secos (8.4.1)		5	Placa 45 mm	150	30-40	SIM
Bolos secos (8.4.1)		5	Placa 45 mm	150	25-35	SIM
Bolos secos (8.4.1)		2 + 5	Placa 45 mm + Grelha	150	25-45	SIM
Bolos secos (8.4.1)		3	Placa 45 mm	175	25-35	SIM
Bolos secos (8.4.1)		2 + 5	Placa 45 mm + Grelha	160	30-40	SIM
Queques (8.4.2)		5	Placa 45 mm	170	25-35	SIM
Queques (8.4.2)		5	Placa 45 mm	170	25-35	SIM
Queques (8.4.2)		2 + 5	Placa 45 mm + Grelha	170	20-40	SIM
Queques (8.4.2)		3	Placa 45 mm	170	25-35	SIM
Queques (8.4.2)		2 + 5	Placa 45 mm + Grelha	170	25-35	SIM
Génoise sem matéria gorda (8.5.1)		4	Grelha	150	30-40	SIM
Génoise sem matéria gorda (8.5.1)		4	Grelha	150	30-40	SIM
Génoise sem matéria gorda (8.5.1)		2 + 5	Placa 45 mm + Grelha	150	30-40	SIM
Génoise sem matéria gorda (8.5.1)		3	Grelha	150	30-40	SIM
Génoise sem matéria gorda (8.5.1)		2 + 5	Placa 45 mm + Grelha	150	30-40	SIM
Torta de maçã (8.5.2)		1	Grelha	170	90-120	SIM
Torta de maçã (8.5.2)		1	Grelha	170	90-120	SIM
Torta de maçã (8.5.2)		3	Grelha	180	90-120	SIM
Pão torrado (9.2.2)		5	Grelha	275	3-6	SIM

* de acordo com o modelo

NOTA: Para cozeduras a dois níveis, os pratos podem ser retirados em alturas diferentes.



TABELA DE FUNÇÕES COMBINADAS AUTOMÁTICAS COM ASSOCIAÇÃO DE VAPOR

Posição do manípulo	Visualização no programador	Alimentos	Quantidade de água a adicionar
		Frango	500 ml de água morna na pingadeira
		Pato	500 ml de água morna na pingadeira
		Peru	500 ml de água morna na pingadeira
		Galinha pintada	800 ml de água morna na pingadeira
		Peixe inteiro (grande)	500 ml de água morna na pingadeira
		Peixe inteiro (plano)	300 ml de água morna na pingadeira
		Peixe pequeno inteiro	300 ml de água morna na pingadeira
		Filete de peixe	300 ml de água morna na pingadeira
		Lombo de porco assado	500 ml de água morna na pingadeira
		Vitela assada	500 ml de água morna na pingadeira

IMPORTANTE

Posicione a pingadeira (com água morna) na grelha de baixo, nível 1 e o seu alimento a cozinhar na grelha no nível 3.

FR

CS

DA

DE

EL

EN

ES

FI

IT

NL

NO

PL

PT

SK

SV

Brandt



POKyny PRE POUŽÍVATEĽA SK

RÚRA

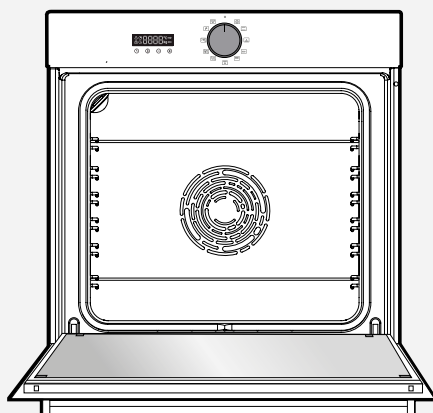

ORIGINE
FRANCE[®]
GARANTIE

BVCert.6011825

Vážený klient,

Práve ste si zakúpili produkt **BRANDT** a my vám ďakujeme za prejavenú dôveru. Tento produkt sme navrhli a vyrobili s ohľadom na vás, váš životný štýl a vaše potreby, aby čo najlepšie vyhovoval vašim očakávaniam. Dali sme do toho svoje know-how, svojho inovačného ducha a všetku vášeň, ktorá nás poháňala viac ako 60 rokov.

V neustálej snahe neustále lepšie vyhovieť vašim požiadavkám je vám k dispozícii náš zákaznícky servis a je vám k dispozícii na zodpovedanie všetkých vašich otázok alebo návrhov.

Prihláste sa tiež na našej webovej stránke **www.brandt.com**, kde nájdete naše najnovšie inovácie, ako aj užitočné a ďalšie informácie.

Spoločnosť **BRANDT** vás rada každodenne podporuje a želá si, aby ste si nákup mohli vychutnať naplno.

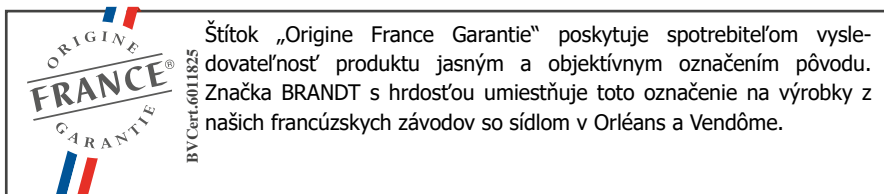

<https://brandt.fr/>

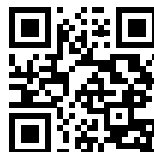

Dôležité:

Pred zapnutím prístroja si pozorne prečítajte tohto sprievodcu, aby ste sa rýchlejšie oboznámili s jeho používaním.



Bezpečnostné pokyny	4
ŽIVOTNÉ PROSTREDIE A ÚSPORA ENERGIE	6
Životné prostredie	6
Tip na úsporu energie	6
inštalácia spotrebiča	7
Voľba umiestnenia a inštalácie	7
Elektrické pripojenie	8
Popis vášho spotrebiča	9
Prezentácia rúry	9
Displej a ovládacie tlačidlá	9
Príslušenstvo	10
Používanie prístroja	12
Nastavenia	12
Ponuka nastavení	13
Režimy varenia	14
Zahájenie varenia	15
Štaroštlivosť o vaše zariadenie	17
Čistenie interiéru - exteriéru	18
Anomálie a riešenia	19
Popredajný servis	21
Intervencie	21
Tabuľky varenia	22
Recepty s droždím	24
Skúšky funkčnej spôsobilosti	25



DÔKLADNE SI PREČÍTAJTE DÔLEŽITÉ BEZPEČNOSTNÉ POKYNY A ODLOŽTE ICH PRE PRÍPAD POTREBY.

Tento návod je možné si prebrať na internetovej lokalite značky.

- Po prevzatí zariadenie okamžite odbaľte. Skontrolujte jeho celkový vzhľad. Akékoľvek výhrady zaznamenajte na dodací list a jeho kópiu si odložte.
-
- **Dôležité:**
 - Tento prístroj môžu používať deti staršie ako 8 rokov a osoby, ktoré majú znížené fyzické, zmyslové alebo mentálne schopnosti, alebo osoby, ktoré nemajú na to skúsenosti a vedomosti, iba vtedy, keď na nich dozerá zodpovedná osoba, alebo ak boli vopred poučené o bezpečnom používaní prístroja a pochopili možné riziká súvisiace s jeho používaním.
 - — Dbajte na to, aby sa deti s týmto zariadením nehrali. Deti nesmú bez dozoru samostatne čistiť prístroj alebo vykonávať jeho údržbu.
 - — Dohliadnite na to, aby sa s prístrojom nehrali deti.
- **UPOZORNENIE:**
 - — Zariadenie a jeho dostupné časti sú počas používania horúce. Dávajte pozor, aby ste sa nedotkli ohrevných častí vnútri rúry. Deti mladšie ako 8 rokov sa nesmú približovať k zariadeniu, pokiaľ nie sú pod stálym dozorom.
 - — Toto zariadenie je určené na pečenie so zatvorenými dvierkami.
 - — Pred spustením čistiaceho cyklu pyrolýzy z rúry vyberte všetko príslušenstvo a odstráňte väčšie nečistoty.
 - — Pri použití čistiacej funkcie sa povrchy môžu rozohriať na vyššiu teplotu ako pri normálnom použití.
 - Preto dbajte, aby sa k rúre nepribližovali malé deti.
 - — Zariadenie nečistite parou.
 - — Na čistenie sklenených dvierok rúry nepoužívajte drsné čistiace prostriedky ani drôtenky, pretože by sa mohol poškrabať povrch, čo by mohlo viesť k prasknutiu skla.
 -



• UPOZORNENIE :

- Pred výmenou žiarovky sa uistite, či je zariadenie odpojené od napájania, aby sa predišlo akémukoľvek riziku úrazu elektrickým prúdom. Zásah vykonajte, keď je zariadenie vychladnuté. Na odskrutkovanie tienidla a žiarovky použite gumenú rukavicu, ktorá uľahčí vymontovanie.

- Po inštalácii musí zástrčka zostať prístupná. Zariadenie sa musí dať odpojiť od napájacej siete buď pomocou elektrickej zástrčky, alebo vypínačom zabudovaným v pevnom rozvode v súlade s inštaláčnymi predpismi.

- — Ak je napájací kábel poškodený, musí ho vymeniť výrobca, jeho popredajný servis alebo podobná kvalifikovaná osoba, aby sa predišlo nebezpečenstvu.

- — Toto zariadenie sa môže nainštalovať kdekoľvek pod pracovnú dosku alebo do vsťavaného nábytku v súlade s inštaláčnou schémou.

- — Rúru umiestnite do stredu nábytku tak, aby bola zaistená minimálna vzdialenosť 10 mm od bočnej steny nábytku. Materiál nábytku, do ktorého je zariadenie

vstavané, musí odolávať teplu (alebo byť pokrytý takýmto materiálom). Kvôli väčšej stabilite rúru k nábytku pripevnite pomocou 2 skrutiek, ktoré umiestnite do otvorov určených na tento účel.

- — Prístroj sa nesmie nainštalovať za ozdobné dvere, aby sa zabránilo prehriatiu.

- — Tento prístroj je určený výhradne na domáce a podobné používanie ako napríklad: v kuchynských kútoch pracovníkov obchodných zariadení, kancelárií a iných profesionálnych odvetví, na farmách, používanie klientmi hotelov, motelov a iných priestorov, ktoré majú ubytovací charakter, používanie v priestoroch ako hosťovské izby.

- — V prípade akéhokoľvek čistenia vnútra rúry musí byť rúra vypnutá.

- Neupravujte vlastnosti tohto prístroja.

- Nepoužívajte rúru na skladovanie či uchovávanie potravín ani na odkladanie predmetov po ich použití.



OCHRANA ŽIVOTNÉHO PROSTREDIA

Baliace materiály tohto zariadenia sú recyklovateľné. Podieľajte sa na recyklácii a prispievajte k ochrane životného prostredia a uložte ich do komunálnych kontajnerov určených na tento účel. Toto zariadenie obsahuje tiež mnoho recyklovateľných materiálov. Je označené týmto logom,



ktorý označuje, že opotrebované zariadenia sa nesmú miešať s ostatnými odpadmi.

Výrobca bude zariadenia recyklovať v najlepších podmienkach v súlade s európskou smernicou 2002/96/ES o likvidácii elektrických a elektro-

nických zariadení.

Podrobné informácie o najbližších zberných miestach opotrebovaných zariadení získate od mestského úradu alebo predajcu.

Ďakujeme vám za vašu spoluprácu v oblasti ochrany životného prostredia.

TIP NA ÚSPORU ENERGIE

Počas varenia nechajte dvierka rúry zatvorené.



VÝBER MIESTA A ZAPUSTENIE

Na nákresoch sú uvedené rozmery nábytku, do ktorého bude vložená rúra.

Tento prístroj možno nainštalovať nezávisle pod pracovnú dosku (obr. A) alebo do vstavaného nábytku (obr. B).

Upozornenie: Ak je spodná skrinka otvorená (pod pracovnú dosku alebo do vstavaného nábytku), priestor medzi stenou a doskou, na ktorej je umiestnená rúra, musí byť maximálne 70 mm (obr. C) (obr. D). Upevnite rúru do nábytku. Na tento účel odstránenie gumené pätky a prevrtajte najprv otvor s priemerom 2 mm, aby ste zabránili rozštiepeniu dreva. Rúru upevnite pomocou 2 skrutiek. Znova nasad'te gumené pätky.



Odporúčanie

S cieľom zaistiť kompatibilnú inštaláciu môžete zavolať odborníka pre domáce spotrebiče.



pozornosť:

Ak elektrická inštalácia vo vašej domácnosti vyžaduje zmenu zapojenia zariadenia, zavolajte kvalifikovaného elektrikára. Ak rúra vykazuje niekoľko odchýlok, odpojte zariadenie alebo vyberte poistku zodpovedajúcu napájaciemu káblu rúry.

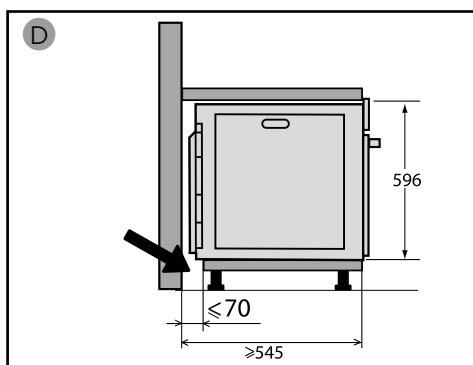
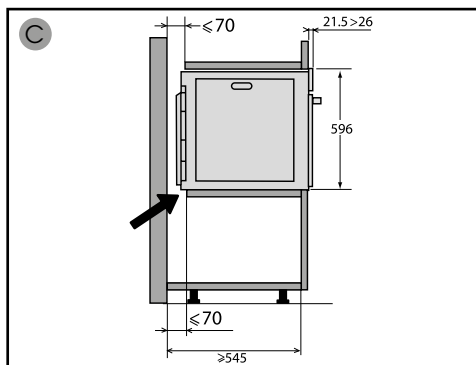
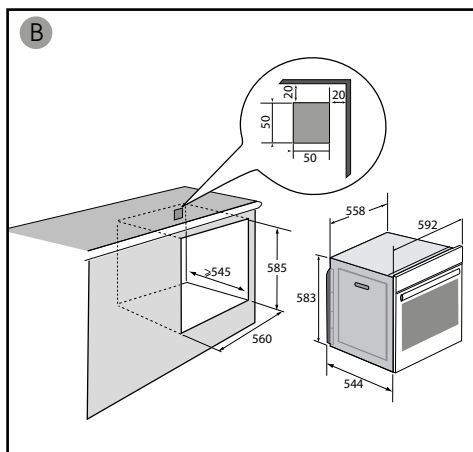
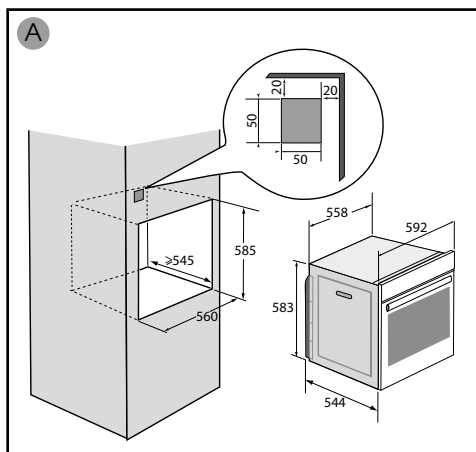



ELEKTRICKÉ ZAPOJENIE

Rúra sa musí zapojiť pomocou normalizovaného napájacieho kábla s 3 vodičmi s priemerom 1,5 mm² (1 f + 1 N + uzemnenie), ktoré sa musia pripojiť na sieť 220~240 V pomocou normalizovanej zásuvky IEC 60083 alebo všepólovým odpojovacím zariadením v súlade s platnými inštalačnými predpismi.



pozornosť:

Ochranný vodič (zeleno-žltý) sa zapája na svorku zariadenia a musí byť napojený na uzemnenie inštalácie. Poistka musí mať minimálne 16 A.

Naša záruka sa nevzťahuje na prípad nehody alebo incidentu, ktoré boli spôsobené nepoužitím uzemnenia, chybného alebo nesprávneho uzemnenia ani v prípade zapojenia v rozpore s pokynmi.

• Pred prvým použitím

Pred prvým použitím rúru na pečenie zahrejte prázdnu so zatvorenými dvierkami asi 15 minút na najvyššiu teplotu. aby sa zariadenie mohlo nabúrať. Minerálna vlna, ktorá obklopuje dutinu pece, môže na začiatku svojim zložením vydávať zvláštny zápach. Rovnako si môžete všimnúť dym. To všetko je normálne.

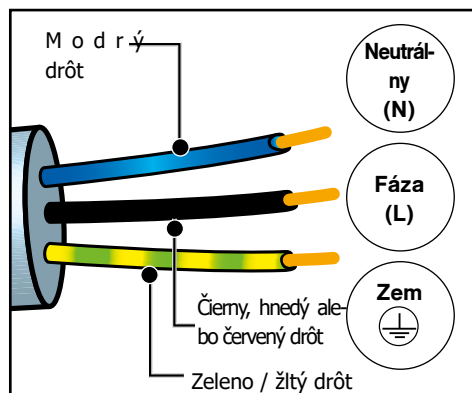



Zoznámenie sa so zariadením

PREZENTÁCIA RÚRY

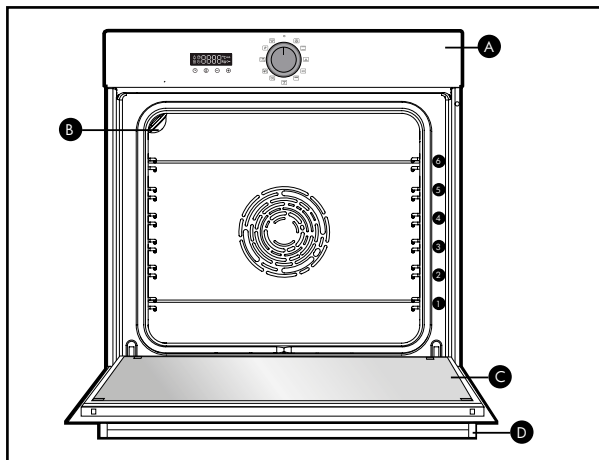

A Ovládací panel

B Lampa

C Dvere

D Rukoväť

Táto rúra má 6 držiakov na umiestnenie príslušenstva (mriežka, misa...) v rôznych výškach v závislosti od

• DISPLEJ



- Trvanie pečenia
- Koniec pečenia
- Zámok klávesnice
- Časovač
- Ukazovateľ teploty
- Ukazovateľ predhrievania
- Zamknutie dverí

• TLAČIDLÁ

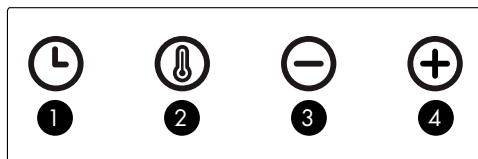

- 1** Nastavenie času a trvania
- 2** Nastavenie teploty
- 3** Zníženie hodnoty
- 4** Zvýšenie hodnôt



PRÍSLUŠENSTVO

• Bezpečnostná mriežka proti sklopeniu

Mriežku možno používať na držanie všetkých nádob a foriém s potravinami na pečenie alebo grilovanie. Používa sa na grilovanie (položené priamo na ňu).

Vložte zarážku proti sklopeniu na dno rúry.

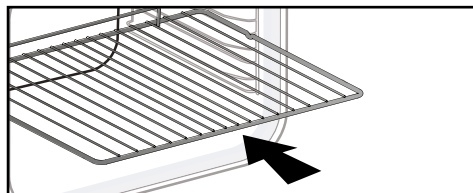

• Nádobu na viacnásobné použitie, panvica 45 mm

Vkladá sa na držiaky pod mriežku, držiak smerom k dverám rúry. Zhromažďuje šťavu a tuk z grilovaného mäsa, možno ju použiť na naplnenie vodou do polovice na pečenie nad vodným kúpeľom.



• Plech na pečivo, 20 mm

Vkladá sa na držiaky, držiak smerom k dverám rúry. Ideálna na pečenie koláčov, sušienok, košíčkov. Jej naklonená rovina umožňuje ľahko umiestniť riad do misky. Možno tiež vložiť do rúry pod mriežku na zachytávanie štiav a tuku z grilovaného mäsa.

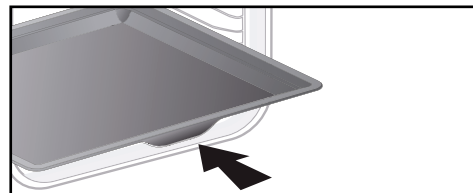

• Systém vodiacich drážok

Vďaka novému systému vodiacich drážok je manipulácia s potravinami praktickejšia a jednoduchšia, pretože sa misky dajú ľahko vybrať, čo maximálne zjednodušuje manipuláciu s nimi. Misky možno úplne vybrať, čo umožní úplný prístup. Okrem toho jej stabilita umožňuje pracovať a manipulovať s potravinami bezpečne, čím sa znižuje riziko popálenia. Jedlo z rúry môžete tiež vybrať omnoho jednoduchšie.

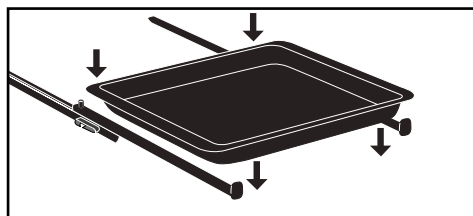

 **Vytiahnite príslušenstvo a držiaky rúry pred začatím čistenia pyrolýzou.**

Odporúčanie

Na zabránenie uvoľňovaniu dymu počas prípravy masťného mäsa odporúčame pridať malé množstvo vody a oleja na dno panvice.



INŠTALÁCIA A DEMONTÁŽ POSUVNEJ KOĽAJE

Po odstránení 2 stupňovitých drôtov zvolte výšku schodov (od 2 do 5), ku ktorým chcete pripevniť svoje koľajnice. Zcvaknite ľavú koľajnicu o ľavý schod pomocou dostatočného tlaku na prednú a zadnú časť koľajnice tak, aby 2 jazýčky na bočnej strane koľajnice zapadli do drôtenej police. Rovnakým spôsobom postupujte pre pravú koľajnicu.

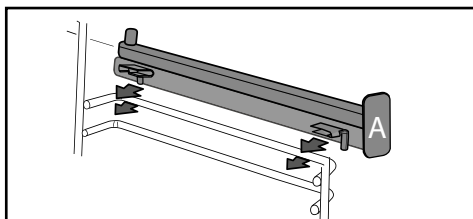

POZNÁMKA: teleskopická posuvná časť drážky sa musí vysunúť smerom k prednej časti rúry, zarážka je otočená smerom k vám.

Namontujte 2 stupňovité držiaky a vložte dosku na 2 drážky. Systém je pripravený na použitie.

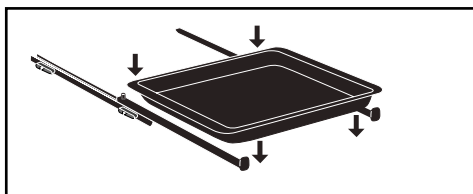

Ak chcete koľajnice demontovať, znova odstráňte kroky drôtu.

Mierne rozťahnite jazýčky pripravené ku každej koľajnici smerom nadol, aby ste ich uvoľnili zo schodu. Potiahnite zábradlie smerom k sebe.

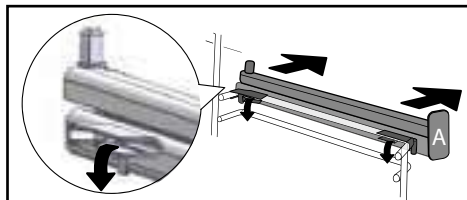

Pod vplyvom tepla sa môže príslušenstvo deformovať, čo však nemá vplyv na jeho funkcie. Umožňuje mu dostať sa do pôvodného tvaru po ochladení.



NASTAVENIE

• NASTAVENIE ČASU

Pri zapnutí displeja bliká 12:00.

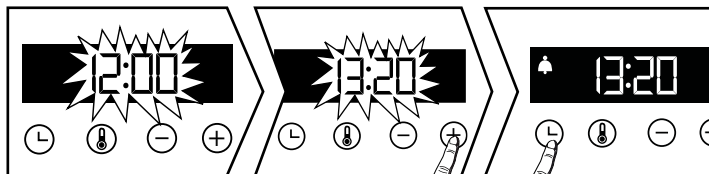

Nastavte čas pomocou tlačidiel + alebo -. Potvrďte tlačidlom . V prípade výpadkov elektriny hodiny blikajú.

• ZMENA ČASU

Volič funkcií musíte nastaviť na nulu.

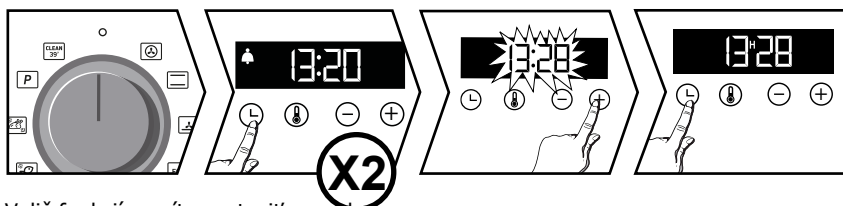

Volič funkcií musíte nastaviť na nulu.

Stlačte tlačidlo na časovači sa zobrazí symbol . Znova stlačte tlačidlo , a zmeňte čas pomocou tlačidiel + alebo -. Potvrďte tlačidlom .

• ČASOVAČ

Túto funkciu možno použiť len pri vypnutej rúre.

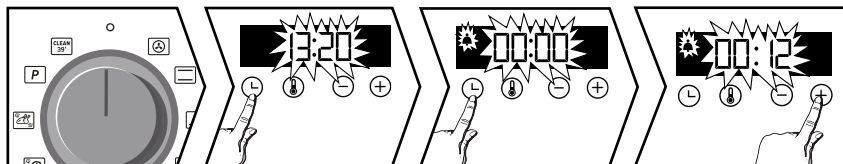

Volič funkcií musíte nastaviť na nulu.

Stlačte tlačidlo . Časovač zabliká . Nastavte časovač pomocou tlačidiel + alebo -. Stlačte tlačidlo .



Pozn. : Programovanie časovača môžete kedykoľvek zmeniť alebo zrušiť. Pre zrušenie sa vráťte do ponuky časovača a nastavte na 00:00. Bez overenia sa záznam uskutoční automaticky po niekoľkých sekundách.

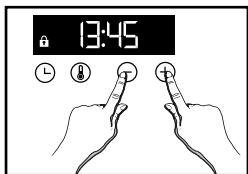

Pomocou vášho zariadenia

• ZAMKNUTIE OVLÁDACÍCH PRVKOV



Súčasne stlačte tlačidlá + a –, kým sa na obrazovke nerozsvieti symbol . Ak chcete odomknúť, stlačte súčasne tlačidlá + a –, kým sa na obrazovke nerozsvieti symbol .

MENU NASTAVENIA

Môžete zmeniť rôzne parametre vašej rúry. Postup: Stlačte tlačidlo  na niekoľko sekúnd, kým sa na obrazovke nezobrazí označenie „MENU“, ktoré umožňuje prístup k režimu nastavenia.

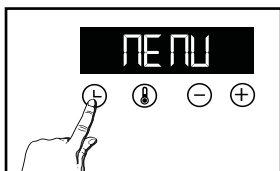

Znovu stlačte tlačidlo  na prechádzanie v rámci rôznych nastavení.

Rôzne parametre aktivujte alebo deaktivujte pomocou tlačidiel + a –. Pozrite si nasledujúcu tabuľku.

	Svetlo: Poloha ON (ZAP.), svetlo zostane svietiť počas pečenia (okrem funkcie ECO). Poloha AUTO, svetlo rúry sa vypne pri pečení po 90 sekundách.
	Zvuky – pípnutia: Poloha ON (ZAP.), aktívne zvuky Poloha OFF (VYP.), žiadne zvuky
	Predhrievanie: Poloha ON (ZAP.), aktívna Poloha OFF (VYP.), bez predhrievania.
	Režim DEMO: Poloha ON (ZAP.), aktívny režim Poloha OFF (VYP.), normálny režim rúry

Režim „MENU“ ukončíte znova stlačením tlačidla  na niekoľko sekúnd.



Pomocou vášho zariadenia

REŽIMY VARENIA

RUČNÉ FUNKCIE:



KONVEKCIA *

Teplota min. 35 ° C največ 275 ° C

Príporočené za ohranjanje vlážnosti belega mesa, rib in zelenjave.



TRADIČNÁ

Teplota min. 35 ° C, max. 275 ° C

Odporúča sa na pomalé a jemné varenie: mäkká hra. Pečieme pečienky z červeného mäsa. Dusit' v uzavretej zapekacej miske, ktorá predtým začala na varnej doske (coq au vin, guláš).



ZEMINY IMPULZ

minimálna teplota 75 ° C max 250 ° C

Odporúča sa na mokré jedlá (quiche, ovocné ovocné koláče ...). Cesto bude zospodu dobre uvarené. Odporúča sa na kysnutie (koláče, briošky, kouglof ...) a na suflé, ktoré nebudú blokovane kôrkou.



ECO*

Teplota min. 35 ° C, max. 275 ° C

Táto pozícia umožňuje získať energiu pri zachovaní vlastností pečenia. V tomto poradí možno pečenie vykonať bez predhrievania.



SILNÝ GRIL

Teplota min. 180 ° C, max. 275 ° C

Odporúča sa na grilovanie toastov, gratinovanie jedla, opekanie crême brûlée ...



IMPULZOVÝ GRIL

Teplota min. 100 ° C, max. 250 ° C

Hydina a pečené mäso šťavnaté a chrumkavé na všetkých stranách

Potiahnite panvicu na nižší držiak.

Odporúča sa na všetky druhy hydiny alebo pečeného mäsa, na opekanie a pečenie kolien, hovädzích rebier.

Na uchovanie prísad rybích steakov.

Automatické funkcie:

Spoločnosť Brandt vám ponúka 3 nové funkcie, ktoré automaticky kombinujú dva režimy pečenia: tradičné pečenie a pečenie nad parou, aby sa zachovali výživné hodnoty potravín a zaručilo rýchlejšie pečenie.



BIELE MÄSO

Odporúča sa, aby sa zachovalo pečené bravčové a teľacie mäso mäkké a šťavnaté.



RYBY

Odporúča sa na pečenie celých rýb alebo file.



HYDINA

Odporúča sa na pečenie kurčiat, moriek, perličiek a kačíc.

Pri týchto 3 funkciách stačí na plech (do odkvapkávacej nádoby) dať dostatočné množstvo teplej vody a vložiť ho do rúry na spodnú priečku a potraviny na pečenie umiestniť na 3. úroveň.

Informácie o množstve vody v odkvapkávacej nádobe sú uvedené na konci návodu v tabuľke automatických kombinovaných funkcií s použitím pary.



Systém „Smart Assist“

Vaša rúra je vybavená funkciou „Smart Assist“, ktorá pri programovaní doby pečenia odporučí upravitel'nú dobu pečenia podľa zvoleného režimu pečenia.

**Režim pečenia sa vykonáva podľa požiadaviek normy EN 60350-1: 2016 na preukázanie súladu s požiadavkami európskeho nariadenia EÚ/65/2014 na energetické označovanie.*



Pomocou vášho zariadenia

ZAHÁJENIE VARENIA

• OKAMŽITÉ PEČENIE

Na programovacom zariadení by sa mal zobrazovať len čas. Nemá blikať.

Otočte volič funkcií do polohy podľa vášho výber

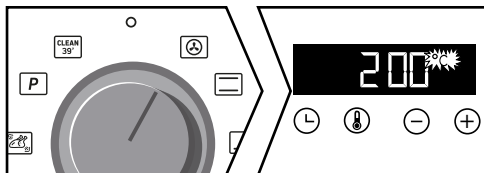



Manuálne funkcie:

Teplota sa začne okamžite zvyšovať. Rúra vám odporučí teplotu, ktorú môžete zmeniť. Rúra sa zohreje a indikátor teploty zabliká. Keď teplota dosiahne nastavenú hodnotu, zaznie séria pípnutí.

Automatické funkcie:

Na displeji sa zobrazí .

Pomocou tabuľky na konci návodu vyberte potraviny. Tlačidlá + a - stláčajte dovtedy, kým sa na displeji nezobrazí požadovaná schéma, a potom potvrdte tlačidlom .

Bliká hmotnosť – pomocou tlačidiel + a - zadajte hmotnosť potravín a potom potvrdte .

Už nemusíte nastavovať nič iné, teplota a čas pečenia sa vypočíta automaticky. Bliká čas ukončenia pečenia, potvrdte tlačidlom .



• NASTAVENIE TEPLoty

Keď sa presuniete na požadovanú funkciu pečenia, stlačte tlačidlo .

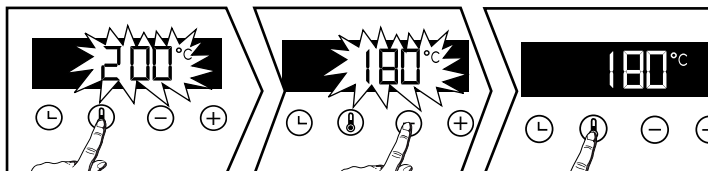
Teplotu zmeňte pomocou tlačidiel + a -.Potvrdte ho stlačením tlačidla .



• NAPROGRAMOVANIE TRVANIA

Vykonajte , okamžité pečenie a  trvanie pečenia zabliká. Potom bude možné vykonať nastavenia. Stlačte tlačidlo + alebo - a nastavte trvanie pečenia

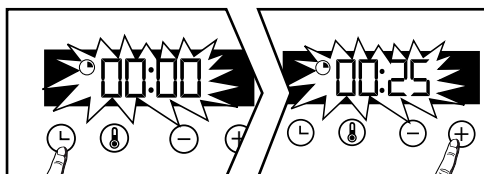



Vaša rúra je vybavená funkciou „SMART ASSIST“, ktorá vám po naprogramovaní trvania odporučí trvanie pečenia, ktoré môžete zmeniť podľa zvoleného pečenia.

Pozrite si nasledujúcu tabuľku.

Čas varenia sa automaticky uloží po niekoľkých sekundách. Čas sa odpočítava okamžite po dosiahnutí teploty varenia.

FUNKCIA PEČENIA	ODPORÚČANIE ČASU
	30 min
	30 min
	30 min
ECO	30 min
	7 min
	15 min

• Zmena konca doby varenia

Pokračujte ako naprogramované trvanie. Po nastavení času varenia stlačte tlačidlo , koniec času varenia bliká.

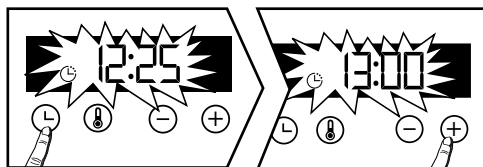

Displej bliká a pomocou + alebo - nastavte koniec doby pečenia.

Koniec pečenia sa zaznamená automaticky po niekoľkých sekundách. Displej konca pečenia už neblinká.





Upozornenie

Pred spustením čistenia pyrolýzou z rúry vyberte príslušenstvo a mriežky. Pred čistením rúry pyrolýzou odstráňte zvyšky, ktoré mohli vytiect'. Pomocou vlhkej špongie z dvierok odstráňte prebytočné mastnoty.

Z bezpečnostných dôvodov sa čistenie pyrolýzou vykonáva až po automatickom zaistení dvierok, preto dvierka nie je možné odistiť.

• **Okamžité automatické čistenie**

Na programovacom zariadení sa musí zobraziť čas dňa, bez blikania. Pomocou regulátora funkcií  alebo  vyberte jeden automatický čistiaci cyklus:

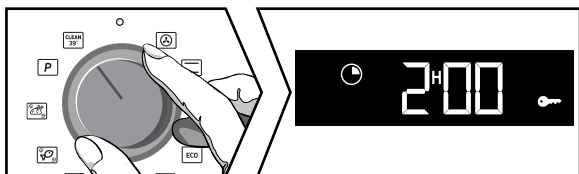





= **Čistenie za 39 minút**

– Na konci každého pečenia sa na displeji zobrazí „Clean 39“ a ponúkne vám možnosť spustenia tohto čistenia. Regulátor nastavte na túto funkciu a potvrdte tlačidlom . Na displeji sa striedavo zobrazuje čas 0:39 a „Clean 39“ a čistenie sa spustí. Po niekoľkých minútach sa zobrazí kľúč, dvierka rúry sa automaticky zaisťia z bezpečnostných dôvodov na celý čas trvania programu.

Ak chcete spustiť cyklus „Clean 39“ so studenou alebo nie dostatočne teplou rúrou, podmienky spustenia tohto programu neumožnia spustiť tento program. Keď sa na displeji zobrazí 0:00, môžete vybrať inú polohu automatického čistenia .

= **Na výber je pyrolýza, ktorá trvá 2 hodiny alebo 1 hodinu 30 minút.** Regulátor prepnite na



Regulátor prepnite na túto funkciu. Na displeji sa zobrazí . Stlačením tlačidla + vyberte pyrolýzu v závislosti od znečistenia rúry.

Na displeji sa zobrazí 2:00 (alebo 1:30) podľa nastaveného programu. Potvrdte tlačidlom . Zobrazí sa  (alebo ) a pyrolýza sa spustí.

Na konci čistenia sa na displeji zobrazí 0:00 a dvierka sa odistia.

Volič vráťte do polohy 0.

• **Oneskorené automatické čistenie**

Máte možnosť oddialiť spustenie pyrolýzy. Keď sa na displeji zobrazí čas trvania programu, stlačte tlačidlo  a pomocou tlačidla + a - nastavte nový čas ukončenia a potom potvrdte tlačidlom . Automatické čistenie sa spustí neskôr tak, aby sa ukončilo v nanovo naprogramovaný čas. Na konci čistenia prepnite volič funkcií do polohy 0.



Starostlivosť o vaše zariadenie

• VONKAJŠÍ POVRCH

Použite mäkkú handričku navlhčenú produktom na čistenie skla. Nepoužívajte čistiaci krém ani drsnú špongiu.

• DEMONTÁŽ STUPŇOVITÝCH DRŽIAKOV

Po zložení stupňovitých držiakov zdvihnite prednú časť stupňovitého držiaka, aby ste vybrali predný háčik z jeho uloženia. Potom mierne vytiahnite zostavu stupňovitého držiaka smerom k sebe a zdvihnite zadnú časť tak, aby ste vybrali zadný háčik z jeho uloženia. Vyberte tak aj 2 stupňovité držiaky.

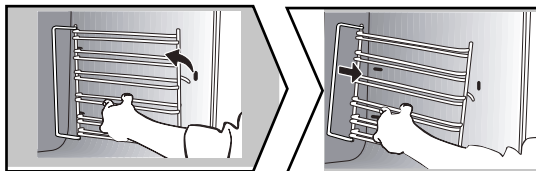

• ČISTENIE VNÚTORNÝCH OKIEN

Upozornenie:

Na čistenie sklenených dvierok rúry nepoužívajte drsné hubky ani drôtenky, pretože by sa mohol poškrabať povrch, čo by mohlo viesť k prasknutiu skla.

Na čistenie vnútorného skla odmontujte dvierka. Pred demontážou skla odstráňte jemnou handričkou a čistiacim prostriedkom na riad nadbytočný tuk z vnútornej strany skla.

• ČISTENIE VNÚTORNÝCH OKIEN

Ouvrez complètement la porte et bloquez-la à l'aide de la câble plastique fournie dans la pochette plastique de votre appareil.

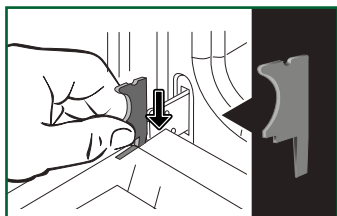

Odstráňte prvé upevnené sklo:

Pomocou druhej zarážky (alebo skrutkovača) zatlačte na miesta, aby ste uvoľnili sklo. Odstráňte sklo:

Dôležité:

Uistite sa, že napodobňujete pocit z prvého nápoja (tvár žiariaca proti vám)



Starostlivosť o vaše zariadenie

Dvierka pozostávajú z dvoch ďalších skiel, ktoré sú na každom rohu upevnené čiernou gumenou pätkou. V prípade potreby ich vyberte a očistite.

Sklá neponárajte do vody. Opláchnite čistou vodou a osušte handričkou, z ktorej sa neuvolňujú vlákna.

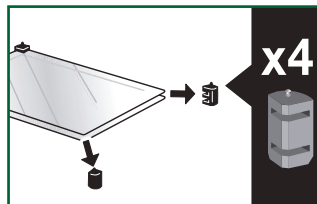
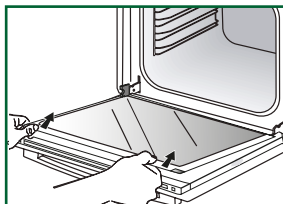
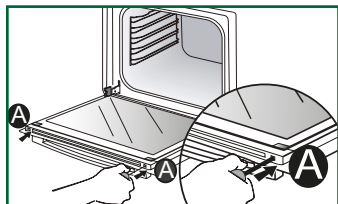

• Spätná montáž okien dverí

Po vyčistení založte späť čierne gumené pätky šípkou nahor a vložte späť všetky sklá.

Zapojte poslednú tabuľu do kovových zarážok, potom ju pritlačte lesklou stranou k sebe. Odstráňte plastový klin. Prístroj je znova pripravený na použitie.

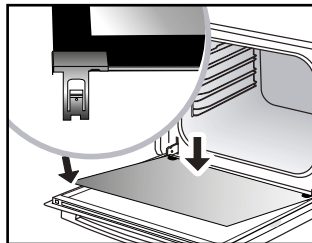
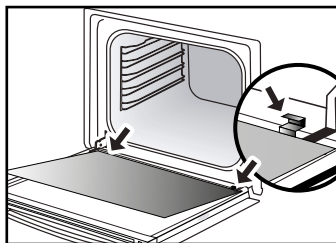
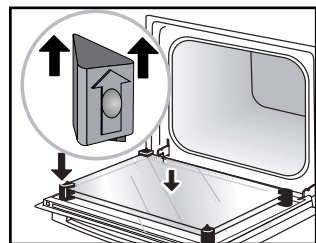

• VÝMENA SVETLA



Upozornenie:

Pred výmenou žiarovky sa uistite, či je zariadenie odpojené od napájania, aby sa predišlo akémukoľvek riziku úrazu elektrickým prúdom. Zásah vykonajte, keď je zariadenie vychladnuté

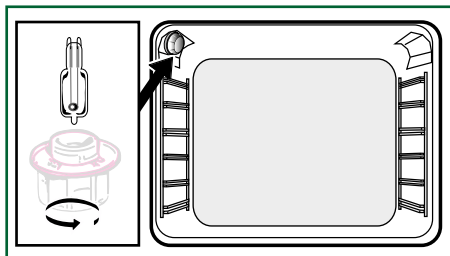

Charakteristika žiarovky:

25 W, 220-240 V~, 300°C, G9.

Ak žiarovky nefungujú, môžete ich vymeniť sami. Zložte tienidlo a potom odskrutkujte žiarovku (použite gumenú rukavicu, ktorá uľahčí vymontovanie). Namontujte novú žiarovku a nasadte späť tienidlo.



ANOMÁLIE A RIEŠENIA

Rúra sa nehreje.

Skontrolujte, či je rúra správne pripojená alebo či poistka vo vašej inštalácii nefunguje. Zvýšte zvolenú teplotu.

Osvetlenie rúry nefunguje.

Vymeňte žiarovku alebo poistku.
Skontrolujte, či je rúra dobre zapojená.

Ventilátor chladenia sa otáča aj po vypnutí rúry.

To je v poriadku, môže sa otáčať maximálne hodinu po pečení, aby odvetral rúru. V opačnom prípade sa obráťte na popredajný servis.

Čistenie pyrolýzou sa nevykoná.

Skontrolujte, či sú dvierka zatvorené. Ak problém pretrváva, obráťte sa na popredajný servis.

Na obrazovke bliká symbol „zamknutie dvierok.“

Vyskytla sa chyba zamknutia dvierok. Zavolajte popredajný servis.

Vibračný hluk.

Skontrolujte, či napájací kábel nie je v kontakte so zadnou stenou.

To nemá žiadny vplyv na správne fungovanie vášho prístroja, môže však pri vetraní generovať vibračný zvuk. Vyberte zariadenie a posuňte kábel. Vymeňte rúru.



ÚSPORNÝ REZIM

Prípadné zásahy na zariadení musí vykonať kvalifikovaný odborník spoločnosti. Počas telefonátu si pripravte všetky potrebné referencie zariadenia (obchodná referencia, referencia servisu, sériové číslo), aby sa zjednodušil proces vybavovania žiadosti. Tieto informácie sa nachádzajú na výrobnom štítku.

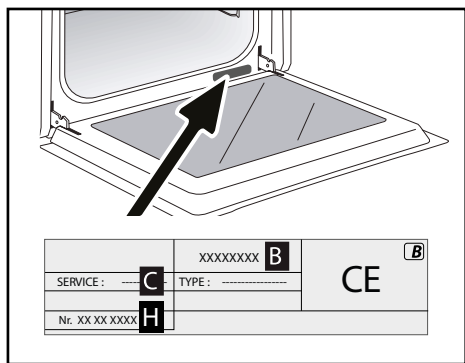

- B: Obchodné referencie
- C: Referenčné číslo služby
- H: Sériové číslo

ORIGINÁLNE NÁHRADNÉ DIELY

V prípade, že by zákrok alebo opravu spravil technik bez oprávnenia, vždy žiadajte potvrdenie o prevedenej práci a trvajte na použití originálnych náhradných dielov.





JEDLÁ	* * * * * * *												min	
Mäso														
Pečené bravčové mäso (1 kg)	200	2					180	2					60	
Teľacie pečené mäso (1 kg)	200	2					180	2					60-70	
Pečené hovädzie	240	2											30-40	
Jahňacie (stehno, plece, 2,5 kg)	220	1			220					200	2		60	
hydina (1 kg)	200	2			220		180	2			210	3	60	
Veľká hydina	180	1											60-90	
Kuracie stehienka					220	3					210	3	20-30	
Bravčové / teľacie rebrá					210	3							20-30	
Hovädzie rebrá (1 kg)					210	3					210	3	20-30	
Baranie rebrá					210	3							20-30	
Ryby														
Grilovaná ryba					275	4							15-20	
Varené ryby	200	3					180	3					30-35	
Pkučeravé ryby	220	3					200	3					15-20	
Zelenina														
Gratiny (varené jedlá)					275	2							30	
Gratins dauphinois	200	2					180	2					45	
Lasagnes	200	3					180	3					45	
Plnené paradajky	170	3					160	2					30	
Pečivo														
Biscuit de Savoie - Génoise			180	2								180	2	35
Sušienková roláda	220	3										180	2	5-10
Brioška	180	1	210									180	2	35-45
Brownies	180	2					175	3						20-25
Torta - Librový koláč	180	1	180	1								180	2	45-50
Clafoutis	200	2					180	3						30-35
Krémy	165	2										150	2	30-40

* Podľa modelu



JEDLÁ														
												min		

Pečivo

Cookies - sušienky	175	3												15-20	
Kugelhopf			180	2									180	2	40-45
pusinky	100	2											100	3	60-70
Madeleines	220	3					200	3							5-10
Choux pečivo	200	3					180	3					180	3	30-40
Malé lístkové cesto	220	3					200	3							5-10
Savarin	180	3											175	3	30-35
Koláč z krehkého cesta	200	1					195	1							30-40
Jemný koláč z lístkového cesta	215	1					200	1							20-25
Koláč z kváskového cesta	210	1					200	1							10-30

Rôzne

Špízy	220	3			210	4									10-15
Paštéta v terine	200	2					190	2							80-100
Krehká pizza	200	2													30-40
Chlieb cesto pizza															15-18
Quiches															35-40
Dych													180	2	50
Koláče	200	2													40-45
Chlieb	220						200		220						30-40
Toast	180				275	4-5									2-3

* Podľa modelu

**Všetky T ° C a doby varenia sú uvedené pre predhriatej rúre**

Pozn .: Pred vložením do rúry musí všetko mäso zostať pri izbovej teplote najmenej 1 hodinu.

ROVNOCEMNOSŤ: OBRÁZKY T ° C

°C	30	60	90	120	150	180	210	240	275
Čísla	1	2	3	4	5	6	7	8	9 maxi



Recept na droždie (v závislosti od modelu)

Zloženie:

- Múka 2 kg • Voda 1240 ml • Soľ 40 g • 4 balíčky dehydratovaných pekárskych kvasníc
- Cesto vymiesime mixérom a cesto necháme v rúre kysnúť.

Postup: Pre recepty na cestoviny na báze kvasníc. Cesto nalejte do odolnej misky zohrejte, odstráňte drôtené police a položte misku na dno.

Rúru predhrejte teplovzdušnou funkciou na 40-50 ° C po dobu 5 minút. Zastavte rúru a nechajte cesto kysnúť 25-30 minút pomocou zvyškového tepla.





FUNKČNÉ SKÚŠKY VHODNOSTI PODĽA NORMY IEC 60350

JEDLO	*Režim varenia	ÚROVEŇ	Príslušenstvo	°C	DURATION min.	PREDOHREV
Krehké pečivo (8.4.1)		5	jedlo45 mm	150	30-40	Áno
Krehké pečivo (8.4.1)		5	jedlo 45 mm	150	25-35	Áno
Krehké pečivo (8.4.1)		2 + 5	jedlo 45 mm + grille	150	25-45	Áno
Krehké pečivo (8.4.1)		3	jedlo 45 mm	175	25-35	Áno
Krehké pečivo (8.4.1)		2 + 5	jedlo45 mm + grille	160	30-40	Áno
Koláčiky malé (8.4.2)		5	jedlo 45 mm	170	25-35	Áno
Koláčiky malé (8.4.2)		5	jedlo 45 mm	170	25-35	Áno
Koláčiky malé (8.4.2)		2 + 5	jedlo 45 mm + grille	170	20-40	Áno
Koláčiky malé (8.4.2)		3	jedlo 45 mm	170	25-35	Áno
Koláčiky malé (8.4.2)		2 + 5	jedlo 45 mm + grille	170	25-35	Áno
Mäkký koláč bez tučný (8.5.1)		4	grille	150	30-40	Áno
Mäkký koláč bez tučný (8.5.1)		4	grille	150	30-40	Áno
Mäkký koláč bez tučný(8.5.1)		2 + 5	jedlo 45 mm + grille	150	30-40	Áno
Mäkký koláč bez tučný(8.5.1)		3		150	30-40	Áno
Mäkký koláč bez tučný (8.5.1)		2 + 5	jedlo 45 mm + grille	150	30-40	Áno
Pre Apple Pie(8.5.2)		1	grille	170	90-120	Áno
Pre Apple Pie(8.5.2)		1	grille	170	90-120	Áno
Pre Apple Pie (8.5.2)		3	grille	180	90-120	Áno
Gratinovaný povrch(9.2.2)		5	grille	275	3-6	Áno

* Podľa modelu

POZNÁMKA: Pri varení na 2 úrovniach je možné pokrmy vybrať v rôznom čase.

FR

CS

DA

DE

EL

EN

ES

FI

IT

NL

NO

PL

PT

SK

SV ◀

Brandt



BRUKSANVISNING SV

UGN

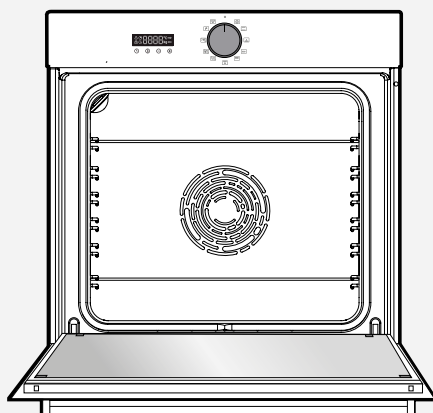

BYCert.6011825

Bästa kund,

Du har just köpt en **BRANDT**-produkt och vi tackar för det förtroende du visat oss. Vi har konstruerat och tillverkat den här produkten med tanke på dig, ditt levnadssätt och dina behov för att den på bästa sätt ska motsvara dina förväntningar. Vi har lagt ner vår kunskap, innovation och passion som har drivit oss i över 60 år.

I en fortsatt ansträngning att bättre kunna möta dina krav, finns vår kundtjänst till ditt förfogande för att svara på alla dina frågor eller förslag.

Logga in på vår webbplats **www.brandt.com** där du hittar våra senaste innovationer tillsammans med nyttig och kompletterande information.

BRANDT är glad att få följa med dig varje dag och önskar dig lycka till med ditt köp.



Etiketten "Origine France Garantie" ger konsumenterna spårbarhet av en produkt genom att ge en tydlig och objektiv ursprungsangivelse. BRANDT-varumärket är stolt över att anbringa denna etikett på produkter från våra franska fabriker med säte i Orléans och Vendôme.

<https://brandt.fr/>

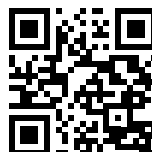

 **Viktigt:**
För att snabbare bekanta dig med hur apparaten fungerar, ber vi dig läsa igenom denna installationsmanual innan du börjar använda apparaten.



Säkerhetsanvisningar	4
MILJÖ OCH ENERGIBESPARING	6
Miljö	6
Tips om energibesparing	6
installera din apparat	7
Val av plats och installation	7
Elektrisk anslutning	8
Beskrivning av din apparat.....	9
Presentation av ugnen	9
Display- och kontrollknappar	9
Tillbehör	10
Använda din enhet	12
Inställningar	12
Inställningsmeny.....	13
Tillagningslägen	14
Starta en matlagning	15
Ta hand om din enhet	17
Interiör - utvändig rengöring	18
Anomalier och lösningar	19
Kundtjänst	21
Interventioner	21
TILLAGNINGSSTÖD	21
Matlagningskartor	22
Recept med jäst	24
Funktionella lämplighetsprov	25
Funktioner med automatisk kombinerad ånga	26



VIKTIGA SÄKERHETSANVISNINGAR ATT LÄSA NOGGRANT OCH SPARA FÖR SENARE BRUK.

Detta dokument finns tillgängligt för nedladdning på märkets webbplats.

- Packa eller låt packa upp apparaten omedelbart vid mottagandet. Kontrollera dess allmänna skick.
- Notera eventuella förbehåll skriftligen på leveransnotan och spara ett exemplar av denna.
-
- **Viktigt:**
 - Denna apparat kan användas av barn från åtta års ålder och av person med begränsad fysisk, känslomässig eller intellektuell förmåga och av person som saknar erfarenhet eller kunskap, då sådan person står under tillsyn eller i förväg fått anvisningar om hur apparaten används på ett säkert sätt och förstått vilka risker han eller hon löper.
 - — Barn får inte leka med apparaten. Rengörings- och underhållsåtgärder får inte utföras av barn som står utan tillsyn.
 - — Barn bör hållas under uppsikt så att de inte leker med apparaten.
 -
- **WARNING:**
 - — Apparaten och de delar av den som går att komma åt blir varma vid användning. Var noga med att inte vidröra någon värmande del inuti ugnen. Barn under åtta års ålder ska hållas på behörigt avstånd, med mindre de står under ständig tillsyn.
 - — Apparaten är avsedd för tillagning med stängd lucka.
 - — Alla tillbehör och större stänkska avlägsnas innan ugnen rengörs med hjälp av pyrolyt.
 - — När rengöringsfunktionen används kan ytorna bli varmare än under normal användning.
 - Vi rekommenderar att barn hålls på avstånd.
 - — Använd inte apparater för rengöring med ånga.
 - — Använd inga rengöringsprodukter som kan repa eller hårda skrapor av metall för att rengöra ugnens glaslucka, eftersom det kan repa ytan och orsaka sprickor i glaset.
 -
- **WARNING :**
 - Undvik eventuell risk för elstöt genom att se till att apparatens strömkabel är fränkopplad innan du byter lampa. Utför bytet när apparaten har svalnat. Använd en gummihandske när du ska skruva loss lampglas och lampa så går det lättare.
 - Det måste gå att komma åt elkontakten efter att apparaten har installerats. Det måste gå att kop-



pla ifrån apparaten från elnätet, antingen via en stickkontakt eller genom att montera en strömbrytare på de fasta ledningskanalerna i enlighet med installationsbestämmelserna.

- — Om nätsladden är skadad ska den för att undvika risk bytas av tillverkaren, dennes serviceavdelning eller av personal med motsvarande behörighet.
- — Som visas i installationsritningen kan apparaten installeras under en bänk eller på höjden.
- — Centrera ugnen i möbeln så att ett mellanrum på minst 10 mm skiljer den från närmaste möbel. Materialet i inbyggnadsmöbeln ska vara värmebeständigt (eller vara klätt i sådant material). Fäst ugnen i möbeln med två skruvar i härför avsedda hål på sidopostererna för högre stabilitet.
- — För att undvika överhettning får apparaten inte installeras bakom en skåpslucka.
- — Denna apparat är avsedd att användas för hushålls- och motsvarande bruk, t.ex. köksutrymmen avsedda för butikspersonal, kontor och annan yrkesverksamhet, lantgårdar, för att användas av hotell- och motellgäster och i andra miljöer av bostadskaraktär och i miljöer av typ hotellrum.
- — Ugnen vara avstängd när man

rengör ugnsutrymmet.

-
- Ändra inte apparatens egenskaper. Det skulle medföra fara för dig.
-
- Använd inte ugnen till förvaring av livsmedel eller för att förvara delar i efter användning.
-



Miljö

Förpackningsmaterialet för den här enheten är återvinningsbart. Ta del i återvinningen och hjälp därmed till att skydda miljön genom att placera dem i de kommunala behållare som tillhandahålls för detta ändamål.



Din apparat innehåller också många återvinningsbara material. Det är därför märkt med den här logotypen för att indikera att begagnade apparater inte bör blandas med annat avfall.

Återvinning av anordningar som anordnas av din tillverkare kommer således att ske under de bästa förhållandena, i enlighet med det gällande europeiska direktivet om avfall som är elektrisk och elektronisk utrustning. Kontakta ditt stadshus eller din återförsäljare för insamlingsställen för begagnade apparater närmast ditt hem.

Vi tackar dig för ditt samarbete när det gäller att skydda miljön.

Tips om energibesparing

Håll ugnsluckan stängd under tillagningen.



Installera din enhet

VAL AV PLACERING OCH INBYGGNAD

I ritningarna anges måtten för den möbel som ska hysa ugnen.

Apparaten kan installeras under en bänk (A) eller på höjden (B). Om möbeln är öppen ska öppningen bak vara högst 70 mm.

Fäst ugnen i möbeln. Ta därför bort gummibussningarna och förborra ett hål med \varnothing 2 mm i möbelns vägg för att undvika att virket spricker. Fäst ugnen med de två skruvarna. Sätt tillbaka gummibussningarna.



Råd

Tveka inte att kontakta en specialist på hushållsmaskiner för att vara säkra på att installationen utförs korrekt.



Kontakta en behörig elektriker om elinstallationen i ditt hem behöver ändras för att ansluta apparaten. Koppla ur apparaten eller plocka bort motsvarande säkring om ugnen uppvisar ett fel av något slag.

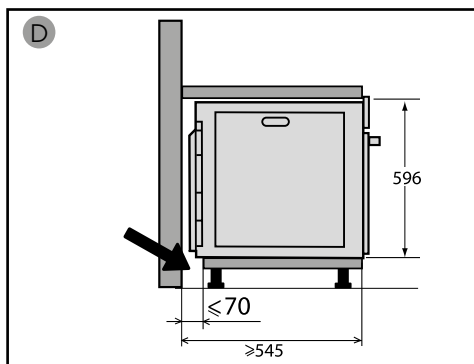
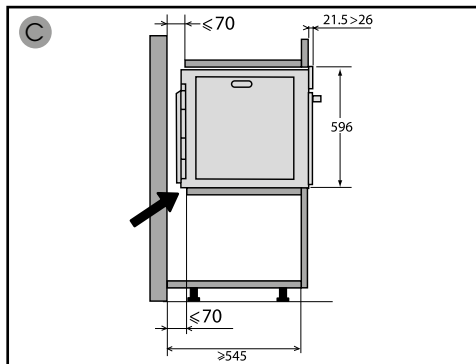
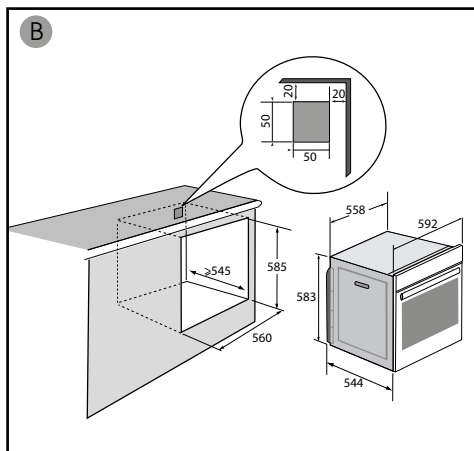
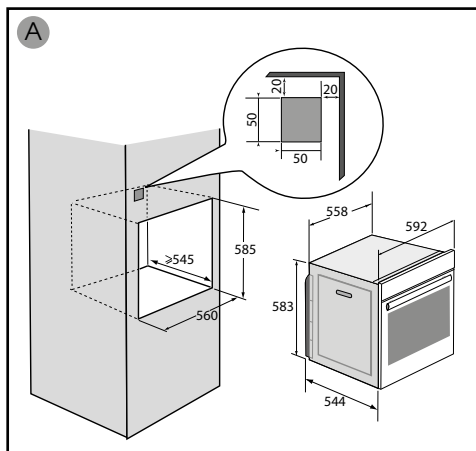



ELANSLUTNING

Ugnen ska anslutas med en matningskabel med tre ledare med 1,5 mm² tvärsnitt (fas, neutral och jord), vilken ska anslutas till ett elnät med 220~240 V via ett uttag enligt standard CEI 60083 eller en allpolig frånskiljningsanordning enligt installationsbestämmelserna.

Attention

Jordledningen (grön/gul) är ansluten till apparatens kopplingsplint  och ska anslutas till installationens jord. Installationen ska ha en säkring på 16 ampere.

Vi kan inte hållas ansvariga för olyckshändelse eller incident till följd av utebliven, defekt eller felaktig jordanslutning och inte heller för elanslutning som inte överensstämmer med reglerna.

• **Före första användning**

Innan du använder ugnen för första gången, värm den tom, med dörren stängd, i cirka 15 minuter på högsta temperatur. för att bryta in enheten. Mineralullen som omger ugnshålan kan initialt avge en speciell lukt på grund av dess sammansättning. På samma sätt kan du märka rök. Allt detta är normalt.

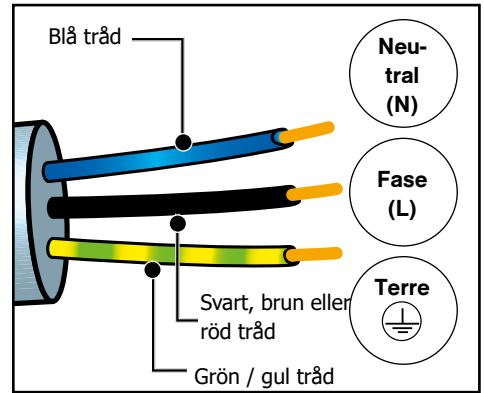



Lär känna din enhet

PRESENTATION AV UGNEN

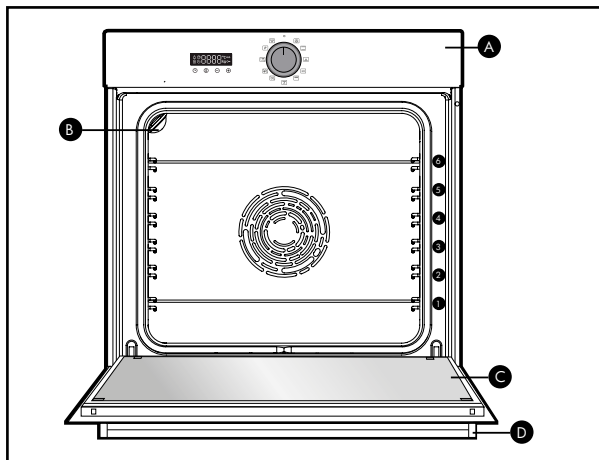

A Reglagepanel

B Lampa

C Lucka

D Handtag

Denna ugn har 6 lägen för tillbehör: från 1 till 6

• Display



- Tillagningstid
- Sluttid för tillagning
- Låsning av display
- Minutur
- emperaturområde
- örvärmning
- Luckspärr

• Knappar

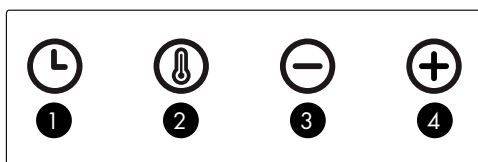

- 1** Inställning av tid och varaktighet
- 2** Temperaturinställning
- 3** Knapp -
- 4** Knapp +



TILLBEHÖR

• Säkerhetsgaller som hindrar omkullvältning

Gallret kan användas för att ställa stekfat och formar med olika rätter som ska tillagas eller gratineras på. Det används för att grilla (maten kan läggas direkt på gallret).

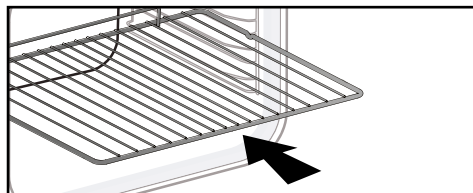

• Universalplåt, dropplåt 45 mm

Skjuts in i stegarna under gallret, med handtaget mot ugnsluckan. Samlar upp sky och stekfett och kan även användas till hälften fylld med vatten för tillagning i vattenbad.



• Plåt 20 mm

Skjuts in i stegarna med handtaget mot ugnsluckan. Idealisk för cookies, mördegskakor, cupcakes. Tack vare den lutande ytan är det lätt att tömma plåten till ett fat. Kan även föras in i stegarna under gallret för att samla upp sky och stekfett.

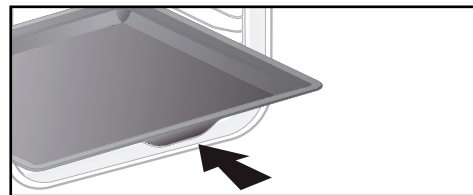

• System med glidskenor

Det nya praktiska systemet med glidskenor med stöd gör det lättare att komma åt och hantera maten, eftersom plåtarna kan dras ut mjukt och utan ryck. Plåtarna kan dras ut helt så att de går att komma åt helt.

Dessutom är de så stabila att man kan arbeta med och hantera maten på ett helt säkert sätt, vilket minskar risken för att bränna sig. Det blir därmed mycket enklare att ta ut maten ur ugnen.

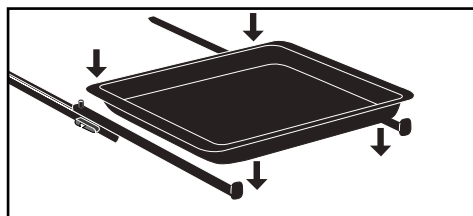

Mise en garde :

Ta ut alla tillbehör och ugnsstegarna ur ugnen innan du startar rengöringen med pyrolys.

Mise en garde :

Sous l'effet de la chaleur les accessoires peuvent se déformer sans que cela n'altère leur fonction. Ils reprennent leur forme d'origine une fois refroidis.



Lär känna din enhet

INSTALLERA OCH DEMONTERA GLIDSKENORNA

Efter att ha tagit ut de två ugnsstegarna väljer man på vilken höjd (2-5) man vill sätta skenorna. Sätt fast vänster ugnssteg på vänster ugnssteg och tryck tillräckligt hårt fram och bak på skenan så att de två hakarna på skenans sida hakar fast i ugnsstegen. Gör på samma sätt med höger skena.

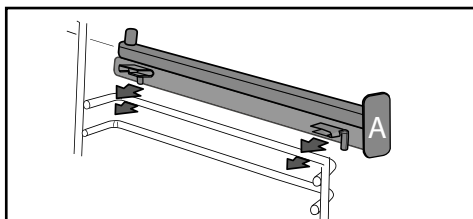

OBS!: glidskenans teleskopiska del ska utvecklas mot ugnens front, med anslaget vänt mot dig.

Sätt de två ugnsstegen på plats och sätt sedan plåten på de två skenorna och systemet är klart att använda.

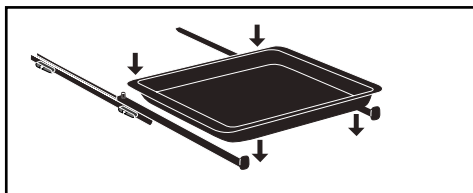

Demontera skenorna genom att åter ta ut ugnsstegen.

Såra försiktigt på de hakar som sitter på skenorna för att frigöra dem från ugnsstegen. Dra skenan mot dig.

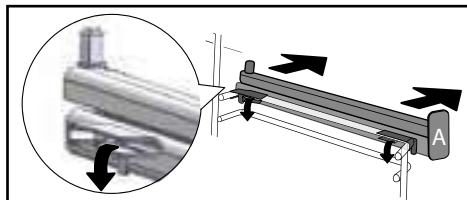

Råd

För att undvika matos vid tillagning av fett kött rekommenderar vi att man har lite vatten eller olja i botten på dropplåten.



INSTÄLLNINGAR

• Inställning av tid

Vid påslagning blinkar 12:00 på skärmen.

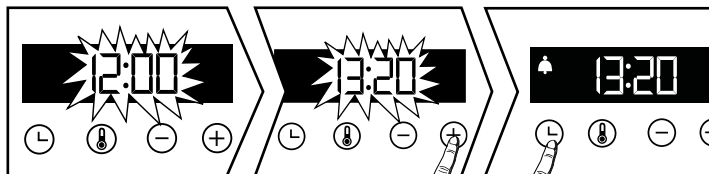

Vid påslagning blinkar 12:00 på skärmen. Ställ in tiden med knappen + eller -. Bekräfta med knappen L. Vid strömavbrott blinkar tiden.

• ÄNDRA TIDEN

Funktionsväljaren måste stå på läge 0.

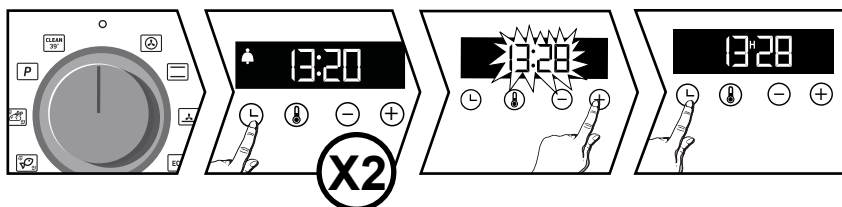

Tryck på knappen L symbolen  visas och tryck igen på L. Ställ in tiden med knappen + eller -. Bekräfta med knappen L. Den ändrade tiden sparas automatiskt efter några sekunder.

• Minutur

Denna funktion kan bara användas när ugnen är avstängd.

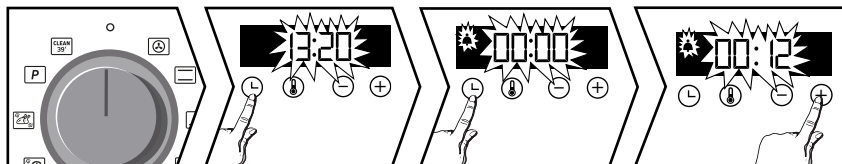

Funktionsväljaren måste stå på läge 0.

Tryck på knappen L symbolen  visas. Ställ in timern med knapparna + och -. Bekräfta med knappen



OBS: Timerns programmering går när som helst att ändra eller avbryta. För att avbryta gå tillbaka till timerns meny och ställ in det på 00:00. Utan bekräftelse registreras ändringen automatiskt efter några sekunder.

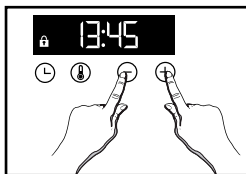

Använda din enhet

• LÅSNING AV DISPLAY





Tryck samtidigt på knapparna + och - till dess att symbolen  visas på skärmen. För att låsa upp reglagen trycker du samtidigt på knapparna + och - till dess att symbolen  försvinner från skärmen.

MENY

Du kan ändra inställningarna för din ugn så här:

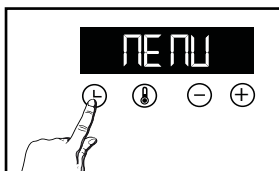
Tryck på knappen tills «MENU» visas för att öppna inställningsläget.



Tryck igen på knappen  för att bläddra mellan de olika inställningarna. Aktivera eller inaktivera inställningarna med knapparna + och -, se tabellen nedan:

	AUTO: I tillagningsläge släcks ljuset i ugnen efter 90 sekunder ON: I tillagningsläge lyser lampan konstant.
	Aktivera/inaktivera knapparnas ljudsignal
	Aktivera/inaktivera föruppvärmningsläget
	Aktivera/inaktivera demonstrationsläget

För att gå ur "MENYN" tryck en gång till på .



Använda din enhet

TILLAGNINGSSÄTT

Fonctions manuelles :



VARMLUFT*

Temperatur minst 35°C högst 250°C

Rekommenderas för att vitt kött, fisk och grönsaker ska behålla sin saftighet. För tillagning samtidigt på upp till tre nivåer.



TRADITIONELL

Temperatur minst 35°C högst 275°C

Rekommenderas vid långsam och känslig tillagning som saftigt vilt osv. Bryna rött kött. För att småkoka rätter i gryta med lock som påbörjats på hällen (coq au vin, grytor).



UNDERVÄRME PULS

Temperatur minst 75°C högst 250°C

Rekommenderas för varma rätter (quiches, frukt-pajer, saftiga...). Degen blir krispigare undertill. För tillagningar som ska jäsa (tårta, brioche, kouglof...) och suffléer som inte täcks av en skorpa.



ECO*

Temperatur minst 35°C högst 275°C

Med hjälp av detta läge kan man spara energi och behålla samma tillagningsegenskaper. All tillagning sker utan förvärmning.



HÖG GRILL

Temperatur minst 180°C högst 275°C

Rekommenderas för att rosta bröd, gratinera mat, bryna en brylépudding.



GRILLNING PULS

Temperatur minst 100 °C högst 250 °C

Saftiga stekar och fjäderfä med krispig yta runt om.

Skjut in dropplåten på understa ugnsstegen.

Rekommenderas för allt fjäderfä och stekar, för att bryna och genomsteka kylar, T-benstek. För saftigt tillagad fisk.

Automatiska funktioner:

För att bevara matens näringsvärde och få en snabbare tillagning erbjuder Brandt tre nya funktioner som automatiskt kombinerar två tillagningssätt – traditionell och med ånga.



VITT KÖTT

Rekommenderas för att fläsk- och kalvstek ska behålla sin form och bli mör.



FISK

Rekommenderas för att laga till hel fisk och fiskfilé.



FÅGEL

Rekommenderas för att laga till kyckling, kalkon och anka.

För dessa tre funktioner behöver du bara ställa in en plåt (dropplåt) med tillräckligt med ljummet vatten längst ned i ugnsstegen och det som ska lagas till på nivå 3 i ugnsstegen.

I tabellen över automatiska kombinerade funktioner med ånga sist i bruksanvisningen finner du information om hur mycket vatten du ska ha i dropplåten.



Ugnen har en "SMART ASSIST"-funktion som när man programmerar en tillagningstid rekommenderar en tillagningstid som kan ändras, beroende på valt tillagningssätt.

**Tillagningssätt enligt anvisningarna i standard SS-EN 60350-1: 2016, för att styrka att kraven på energimärkning i EU-förordning nr 65/2014 är uppfyllda.*



Använda din enhet

STARTAR EN MATLAGNING

• Startar omedelbar matlagning

Programmeraren ska bara visa tiden. Detta ska inte blinka.

Vrid funktionsväljaren till önskad position.

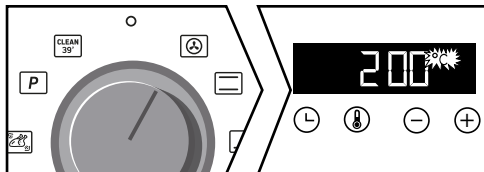

För manuella funktioner:

Temperaturen börjar omedelbart stegras. Din ugn rekommenderar en temperatur som går att ändra. Ugnen blir varm och temperaturindikeringen blinkar. En serie ljudsignaler hörs när ugnen uppnått den inprogrammerade temperaturen.

För automatiska funktioner:

☰ visas på skärmen.

Välj livsmedel med hjälp av tabellen sist i bruksanvisningen. Tryck på knapparna + och - tills önskat schema visas på displayen och bekräfta med knappen ⊖.

En vikt blinkar. Ange den faktiska vikten för ditt livsmedel med knapparna + och - och bekräfta ⊖. Det är allt du behöver ställa in – temperatur och tillagningstid räknas ut automatiskt. Tillagningstiden blinkar. Bekräfta med knappen ⊖. Tillagning startar direkt.

• Temperaturändring

Tryck på ⊕.

Ställ in temperaturen med + eller -. Bekräfta genom att trycka på ⊕.

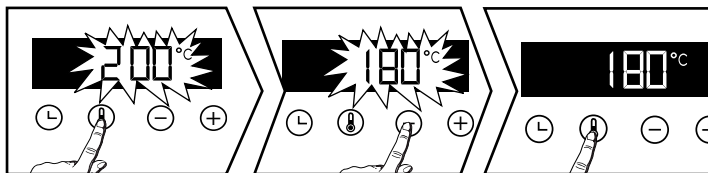

• Programmering av tillagningstid

Utför en omedelbar tillagning och tryck sedan på ⊖, tillagningstid blinkar ⊕ för att ange att inställning är möjlig. Tryck på + eller - för att ställa in tillagningstid.

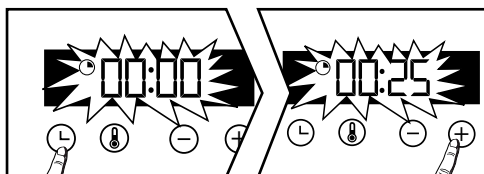



Ugnen har en "SMART ASSIST"-funktion som när man programmerar en tillagningstid rekommenderar en tillagningstid som kan ändras, beroende på valt tillagningssätt. Se nedanstående tabell:

Tillagningstiden sparas automatiskt efter några sekunder. Nedräkningen av tiden börjar omedelbart så snart tillagningstemperaturen har uppnåtts.

TILLAGNINGSFUNKTION	REKOMMENDATION TID
	30 min
	30 min
	30 min
ECO	30 min
	7 min
	15 min

• Tillagning med fördröjd start

Gör som vid en programmerad tid. Tryck på knappen efter att ha ställt in tillagningstiden, tills indikeringen av avslutad tillagning blinkar.

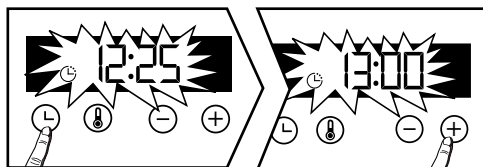

Displayen blinkar för att ställa in tiden för slutet av tillagningen med + eller -. Tiden för avslutad tillagning sparas automatiskt efter några sekunder. Displayen med tiden för avslutad tillagning slutar blinka.



RENGÖRING

• Rengöring med pyrolyys





Observera

Ta ut alla tillbehör och ugnstegarna ur ugnen innan du startar rengöringen med pyrolyys. Alla eventuella större stänk ska avlägsnas innan ugnen rengörs med hjälp av pyrolyys. Avlägsna allt överflödigt fett från luckan med en fuktad svamp.

Av säkerhetsskäl kan rengöringen med pyrolyys bara göras med spärrad lucka. Under denna tid går det inte att låsa upp luckan.

• Omedelbar auto-rengöring

Programverket ska visa dagens tid, utan att blinka. Välj någon av cyklerna för auto-rengöring med funktionsratten  eller  :

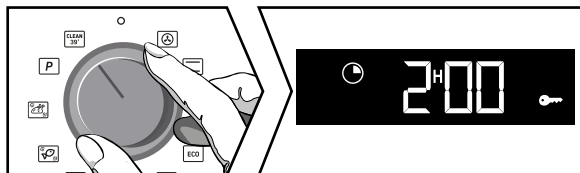





= Rengöring på 39 minuter

– Efter varje tillagning rullar Clean 39 förbi på skärmen för att föreslå att du startar denna rengöring. Ställ ratten på denna funktion och bekräfta med knappen . Tiden 0:39 visas omväxlande med Clean 39 och rengöringen startar. Efter några minuter visas en nyckel. Det betyder att ugnen av säkerhetsskäl automatiskt spärrats under hela den tid programmet körs.

Vill du starta en Clean 39 med kall eller inte tillräckligt varm ugn, hindrar villkoren för att starta programmet från att göra en sådan rengöring. 0:00 visas på skärmen och du måste då välja något annat läge för auto-rengöring  .

= Pyrolyys i två eller 1,5 timmar, beroende på vad du väljer. Ställ ratten på denna funktion.



Ställ ratten på denna funktion.  visas på skärmen. Tryck på + för att välja pyrolyysbehandling beroende på hur smutsig ugnen är.

Beroende på vad du väljer visas tiden 2:00 (eller 1:30). Bekräfta med knappen .  (eller ) visas och pyrolysen startar.

Efter rengöringen visar displayen 0:00 och luckan låses upp.

Vrid funktionsväljaren till 0.

• Fördröjd auto-rengöring

Du kan välja att fördröja pyrolyysbehandlingens start. När programtiden visas på skärmen trycker du på knappen  och ställer in ett nytt klockslag för när den ska vara klar med knapparna + och - och bekräftar med . Auto-rengöringen kommer att starta senare för att vara klar på det nya klockslag som programmerats in. Ställ tillbaka funktionsväljaren på läge 0 efter avslutad rengöring.



• Utvändig rengöring

Använd en mjuk trasa fuktad med glasrengöringsmedel. Använd inte skurpulver eller hårda svampar.

• Nedmontering av ugnsstegar

Lyft upp den främre delen av ugnsstegarna, tryck på hela ugnsstegen och för ut den främre haken ur sitt fäste. Dra sedan försiktigt hela ugnsstegen mot dig och lyft upp de bakre hakarna ur sina fästen. Ta på samma sätt ut båda ugnsstegarna.

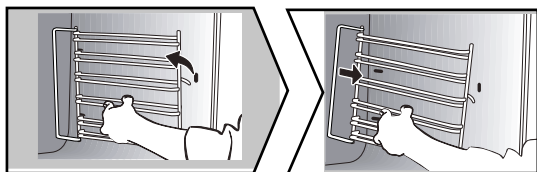

• Rengöra glaset invändigt



Varning

Använd inga rengöringsprodukter som kan repa eller hårda skrapor av metall för att rengöra ugnens glaslucka, eftersom det kan repa ytan och orsaka sprickor i glaset.

Demontera ugnsluckan för att rengöra glaset invändigt. Torka med en mjuk trasa och flytande rengöringsmedel bort överflödigt fett från glaset innan du demonterar glasrutorna.

• Demontering

Öppna luckan helt och spärra den med hjälp av en av de plastkilar som medföljer i plastfickan. Ta bort den festsatta glasrutan:

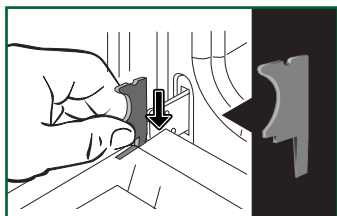

Tryck med ett verktyg (skruvmejsel) vid markeringarna **A** för att ta loss glaset. Ta ut glasrutan.



Viktig:

Se till att du markerar monteringsriktningen för det här första fönstret (blank sida mot dig)



Rengöring

Beroende på modell består dörren av ytterligare två rutor med en svart distansbricka i varje hörn. Ta bort dem vid behov för rengöring.

Sänk inte fönstren i vatten. Skölj med rent vatten och torka av med en luddfri trasa.

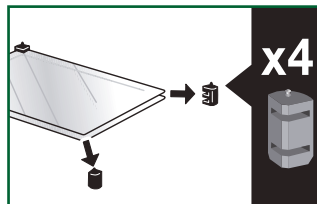
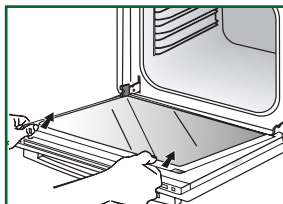
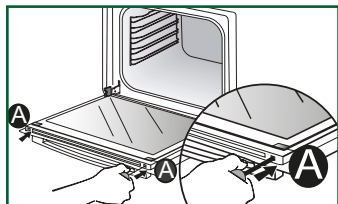

• Sätta tillbaka luckan

Sätt efter rengöring tillbaka de fyra gummibussningarna med pilen uppåt och sätt tillbaka glasrutorna. Sätt efter rengöring tillbaka glasrutan i metallhållarna och fäst den med den glänsande ytan utåt. Ta bort plastkilen.

Apparaten är nu klar att användas igen.

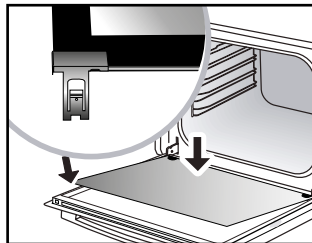
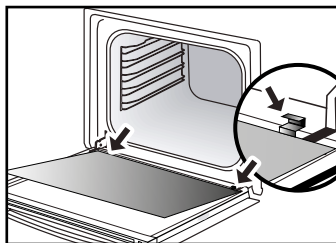
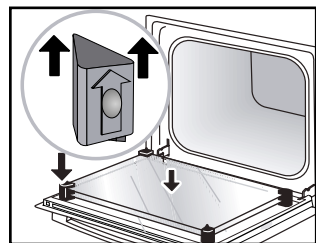

• Byta ugnslampa



Varning:

Undvik eventuell risk för stöt genom att se till att apparatens strömkabel är fränkopplad innan du byter lampa. Utför bytet när apparaten har svalnat.

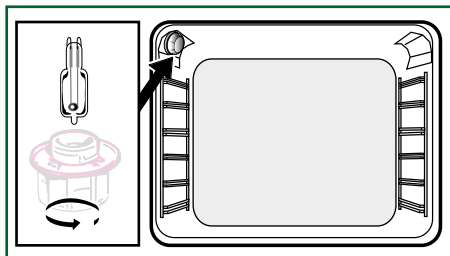

Glödlampans specifikationer:

25 W, 220-240 V~, 300°C, culot G9.

Använd en gummihandske när du ska skruva loss lampglas och lampa så går det lättare.



PROBLEM OCH LÖSNINGAR

Ugnen värms inte.

Kontrollera att ugnen är ansluten till elnätet och att säkringen för installationen inte har löst ut. Höj vald temperatur.

Ugnslampan fungerar inte.

Byt ugnslampa eller säkring. Kontrollera att ugnen är ansluten till elnätet.

Kylfläkten fortsätter att gå efter att ugnen stoppat.

Det är normalt att fläkten kan gå upp till högst en timma efter tillagning för att sänka ugnens inre och yttre temperatur. Kontakta kundservice om den är på längre tid än en timma.

Pyrolysgöringen fungerar inte.

Kontrollera att luckan är stängd. Om det är fel på luckans spärr eller temperaturgivaren, kontakta kundservice.

Symbolen blinkar på displayen.

Dörrlåsningsfel, ring kundtjänst.

Vibrerande ljud.

Kontrollera att nätsladden inte är i kontakt med bakväggen.

Detta påverkar inte enhetens korrekta funktion men kan ändå generera ett vibrerande ljud under ventilation. Ta bort enheten och flytta sladden. Byt ut ugnen.



Service efter försäljning

ÅTGÄRDER

Eventuella åtgärder på apparaten ska utföras av behörig fackman som auktoriserats av märket. Underlätta handläggningen av ditt ärende genom att ha samtliga referenser för din apparat (kommerciell benämning, servicereferens, serienummer) till hands när du ringer. Dessa uppgifter står på märkskylten.

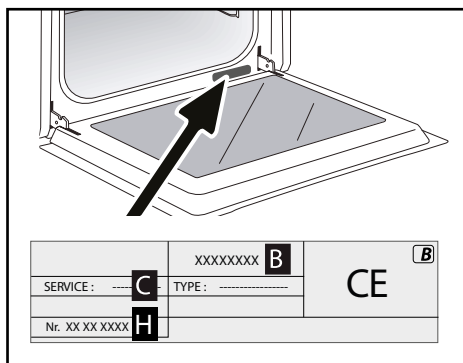

- B: Kommerciell beteckning
- C: Servicereferens
- H: Serienummer

ORIGINALDELAR

Kräv vid serviceåtgärder att endast certifierade originalreservdelar används.





RÄTTER	☰ *		☐ *		☄ *		☷ *		☶ *		☸ *		☹ *		⌚
	☷ NIVA	☷ NIVA	☷ NIVA	☷ NIVA	☷ NIVA	☷ NIVA	☷ NIVA	☷ NIVA	☷ NIVA	☷ NIVA	☷ NIVA	☷ NIVA	☷ NIVA	☷ NIVA	min
Kött															
Fläskstek (1 kg)	200	2					180	2							60
Kalvstek (1 kg)	200	2					180	2							60-70
Oxstek	240	2													30-40
Lamm (stek, bog; 2,5 kg)	220	1			220					200	2				60
Fjäderfä (1 kg)	200	2			220		180	2			210	3			60
Fjäderfä stora delar	180	1													60-90
Kycklinglår					220	3				210	3				20-30
Fläsk- eller kalvkotletter					210	3									20-30
T-benstek (1 kg)					210	3				210	3				20-30
Lammkotletter					210	3									20-30
Fisk															
Grillad fisk					275	4									15-20
Bakad fisk	200	3					180	3							30-35
Fiskfjärilar	220	3					200	3							15-20
Grönsaker															
Gratänger (kokta matvaror)					275	2									30
Potatisgratänger	200	2					180	2							45
Lasagne	200	3					180	3							45
Fyllda tomater	170	3					160	2							30
Bakverk															
Sockerkaka			180	2									180	2	35
Rulltårta	220	3											180	2	5-10
Bullar	180	1	210										180	2	35-45
Brownies	180	2					175	3							20-25
Tårta – Sandkaka	180	1	180	1									180	2	45-50
Clafoutis	200	2					180	3							30-35
Grädde	165	2											150	2	30-40

* Beroende på modell



RÄTTER	☐*		☐*		☐*		☐*		☐*		☐*		☐*		min
	☐ NIVA	☐ NIVA	☐ NIVA	☐ NIVA	☐ NIVA	☐ NIVA	☐ NIVA	☐ NIVA	☐ NIVA	☐ NIVA	☐ NIVA	☐ NIVA	☐ NIVA		
Bakverk															
Madeleinekakor	220	3					200	3							5-10
Petit-choux-deg	200	3					180	3					180	3	30-40
Petit four med smördeg	220	3					200	3							5-10
Savarin	180	3											175	3	30-35
Mördegspaj	200	1					195	1							30-40
Smördegspaj	215	1					200	1							20-25
Jäsdegspaj	210	1					200	1							10-30
Övrigt															
Grillspett	220	3			210	4									10-15
Paté i form	200	2					190	2							80-100
Mördegspizza	200	2													30-40
Bröddegspizza															15-18
Quiche															35-40
Sufflé													180	2	50
Pajer	200	2													40-45
Bröd	220						200		220						30-40
Rostat bröd	180				275	4-5									2-3
Gryta med lock	180	2											180	2	90-180

* Beroende på modell



Alla temperaturangivelser och tillagningstider anges för förvärd ugn

OBS: Innan kött ställs in i ugnen ska det ligga minst en timme i rumstemperatur.

JÄMFÖRELSE: SIFFROR T °C

°C	30	60	90	120	150	180	210	240	275
Siifror	1	2	3	4	5	6	7	8	9 max

Recept med jäst (beroende på modell)

Ingredienser:

● Mjöl 2 kg ● Vatten 1 240 ml ● Salt 40 g ● 4 paket torkad bakjäst

Blanda degen med mixer och jäs den i ugnen.

Förfarande: För recept med deg med jäst. Häll degen i en ugnsfast form, ta ut ugnstegarnas fästen och ställ plåten på botten.

Förvärm ugnen med 40-50 °C med varmluftsfunktionen i 5 minuter. Stäng av ugnen och låt degen jäsa i 25-30 minuter i restvärmen i ugnen.

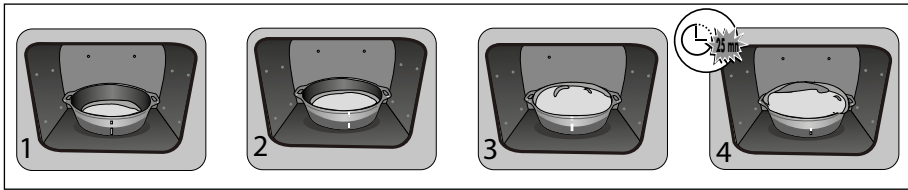



FUNKTIONSTEST ENLIGT STANDARDEN CEI 60350













LIVSMEDEL	* Tillagningssätt	NIVÅ	Tillbehör	°C	TID min.	FÖRVÄRMNING
Mördegskakor (8.4.1)		5	plåt 45 mm	150	30-40	ja
Mördegskakor (8.4.1)		5	plåt 45 mm	150	25-35	ja
Mördegskakor (8.4.1)		2 + 5	plåt 45 mm + galler	150	25-45	ja
Mördegskakor (8.4.1)		3	plåt 45 mm	175	25-35	ja
Mördegskakor (8.4.1)		2 + 5	plåt 45 mm + galler	160	30-40	ja
Små fruktkakor (8.4.2)		5	plåt 45 mm	170	25-35	ja
Små fruktkakor (8.4.2)		5	plåt 45 mm	170	25-35	ja
Små fruktkakor (8.4.2)		2 + 5	plåt 45 mm + galler	170	20-40	ja
Små fruktkakor (8.4.2)		3	plåt 45 mm	170	25-35	ja
Små fruktkakor (8.4.2)		2 + 5	plåt 45 mm + galler	170	25-35	ja
Mjuk kaka utan fett (8.5.1)		4	galler	150	30-40	ja
Mjuk kaka utan fett (8.5.1)		4	galler	150	30-40	ja
Mjuk kaka utan fett (8.5.1)		2 + 5	plåt 45 mm + galler	150	30-40	ja
Mjuk kaka utan fett (8.5.1)		3	galler	150	30-40	ja
Mjuk kaka utan fett (8.5.1)		2 + 5	plåt 45 mm + galler	150	30-40	ja
Äpplepaj (8.5.2)		1	galler	170	90-120	ja
Äpplepaj (8.5.2)		1	galler	170	90-120	ja
Äpplepaj (8.5.2)		3	galler	180	90-120	ja
Gratinerad yta (9.2.2)		5	galler	275	3-6	ja

* Beroende på modell

ANMÄRKNING: För tillagning på två nivåer kan plåtarna tas ut vid olika tillfällen.



TABELL ÖVER KOMBINERADE FUNKTIONER AUTOMATISKA MED ÅNGA

Rattens läge	Visning i programverket	Livsmedel	Mängd vatten som ska tillsättas
		Kyckling	500 ml ljummet vatten i dropplåten
		Anka	500 ml ljummet vatten i dropplåten
		Kalkon	500 ml ljummet vatten i dropplåten
		Pärlehöna	800 ml ljummet vatten i dropplåten
		Hel fisk (stor)	500 ml ljummet vatten i dropplåten
		Hel fisk (plattfisk)	300 ml ljummet vatten i dropplåten
		Små hela fiskar	300 ml ljummet vatten i dropplåten
		Fiskfilé	300 ml ljummet vatten i dropplåten
		Fläskstek	500 ml ljummet vatten i dropplåten
		Kalvstek	500 ml ljummet vatten i dropplåten

VIKTIGT

Placera dropplåten (med ljummet vatten) längst ned i ugnsstegen, nivå 1, och den mat du ska laga till på nivå 3.

